

Status	Rev.	00	Endring	NDANDE	NOTTHY	NDKETT	06.06.2018
FFI				Utført	Kontr.	Ansv.	Date
				Målestokk			Format
				-			A3
				Oppdragsleder:			
				Anders R. Syvertsen			
				Oppdragsnr.			
				28322001			
				Disiplin	Løpenummer:	Status	Rev.
				V	00-310-V-70-001	-	-

SWECO Norge AS
 Drammensveien 260, 0383 OSLO
 TLF.: 87 12 80 00 FAX: 87 12 58 40

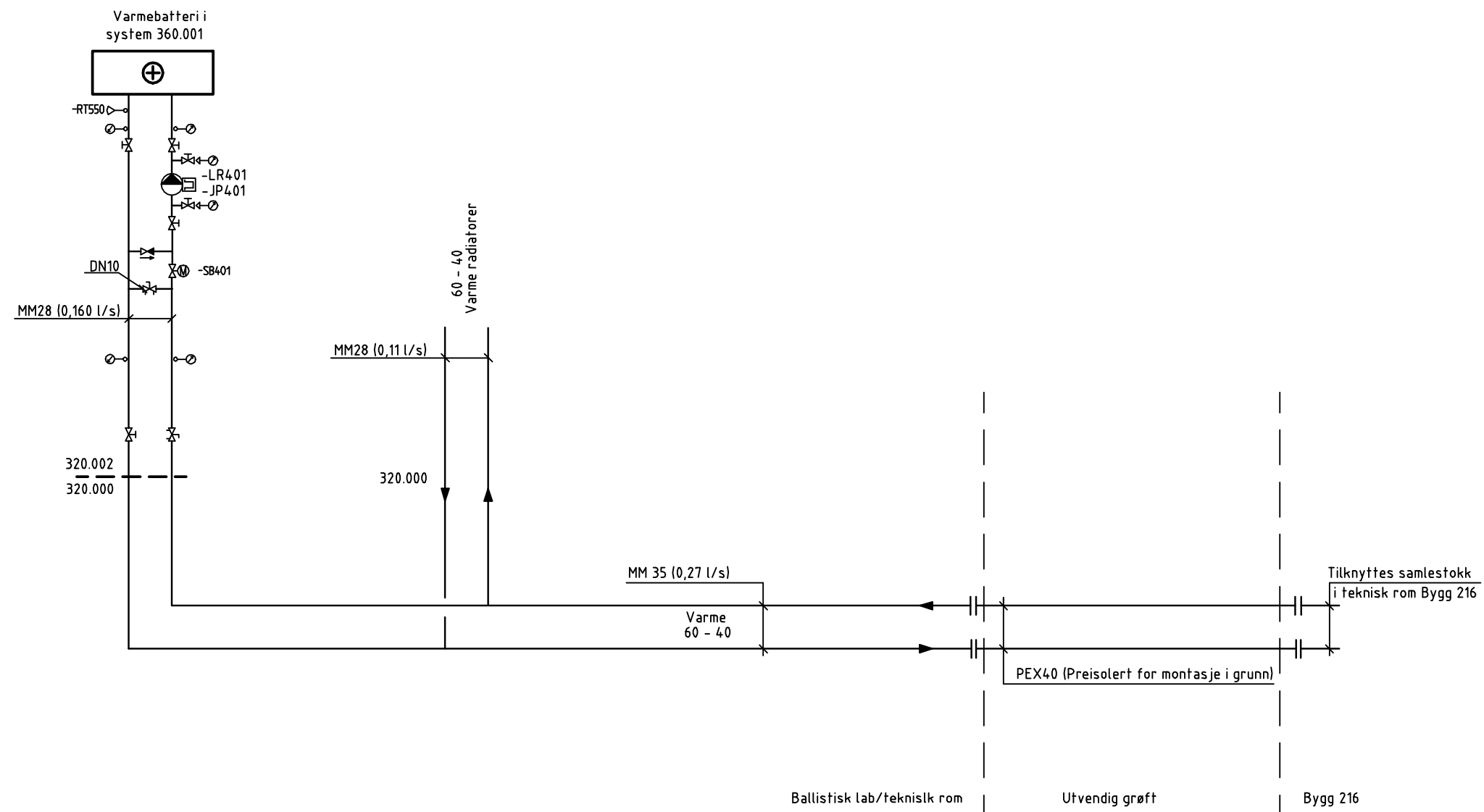

Status	Rev.	Endring	NDANDE	NOTTHY	NDKETT	06.06.2018
FFI			Utført	Kontr.	Ansv.	Date
			Målestokk			Format
			-			A3
			Oppdragsleder:			
			Anders R. Syverisen			
			Oppdragsnr.			
			28322001			
SWECO			Disiplin	Løpenummer:	Status	Rev.
SWECO Norge AS Drammensveien 260, 0383 OSLO Tlf: 87 12 80 00 Fax: 87 12 58 40			V	00-320-V-70-001	-	-

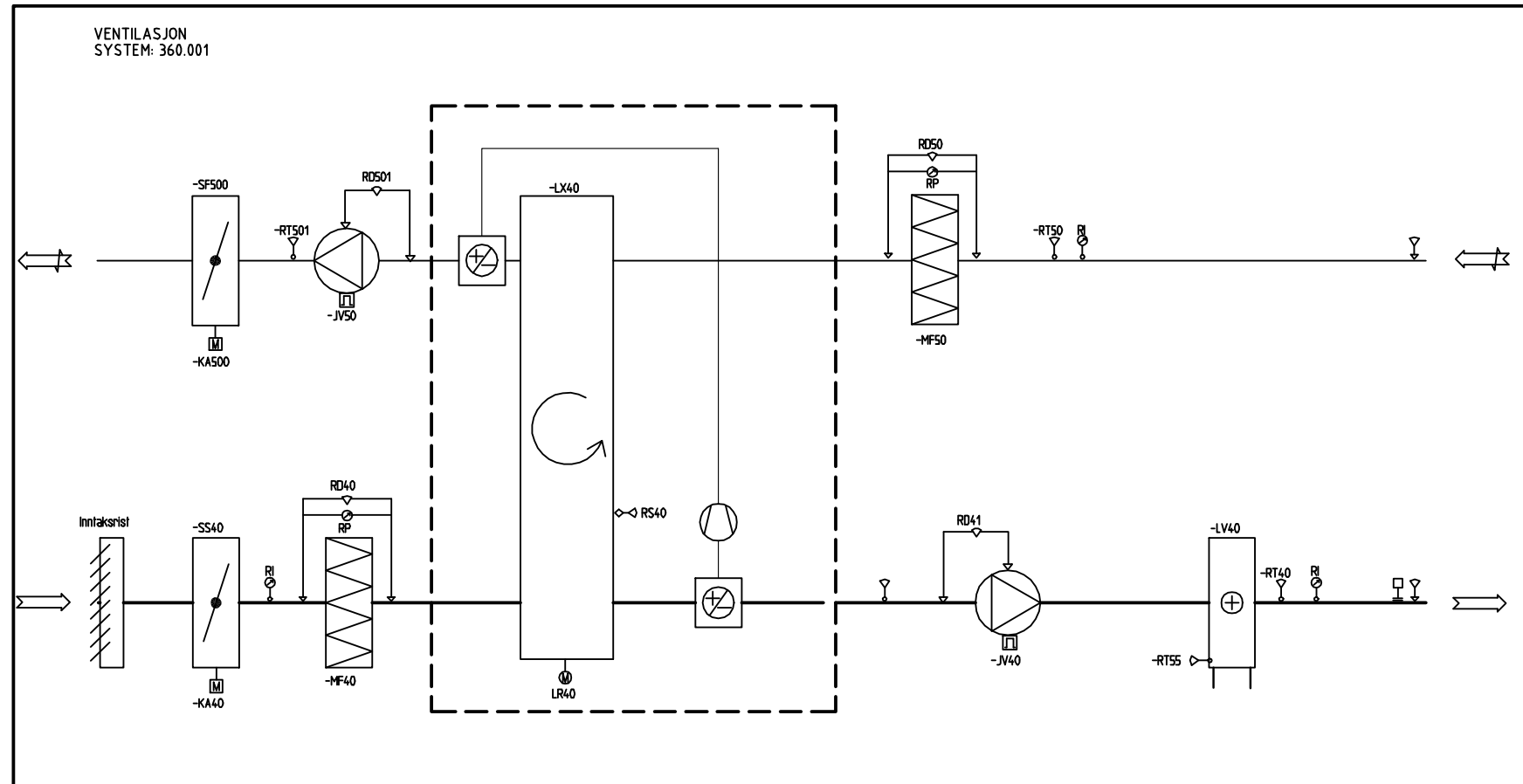

Status	Rev.	Endring	NDANDE	NOTTMY	NDKETT	06.06.2018
FFI						
			Målestokk	Formåt		
			-	A3		
FFI Lab Systemkjema ventilasjon			Oppdragsleder: Anders R. Syvertsen			
			Oppdragsnr. 28322001			
SWECO			Disiplin	Løpenummer	Status	Rev.
SWECO Norge AS Christiansgt. 260, 0303 OSLO Tlf.: 87 12 80 00 Fax: 87 12 58 40			V	00-360-V-70-001	-	-

SKYTEBANE

VENTILASJON STANDPLASS 1

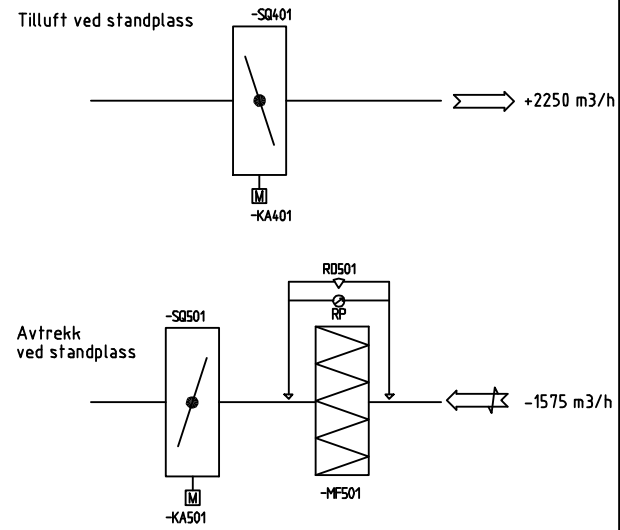

VENTILASJON STANDPLASS 2

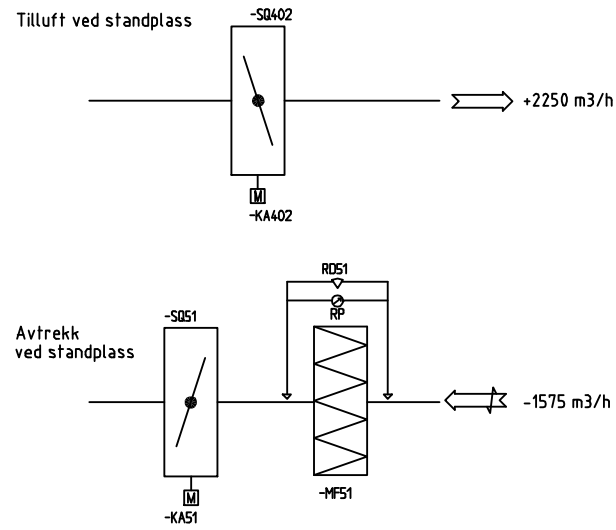

VENTILASJON STANDPLASS 3

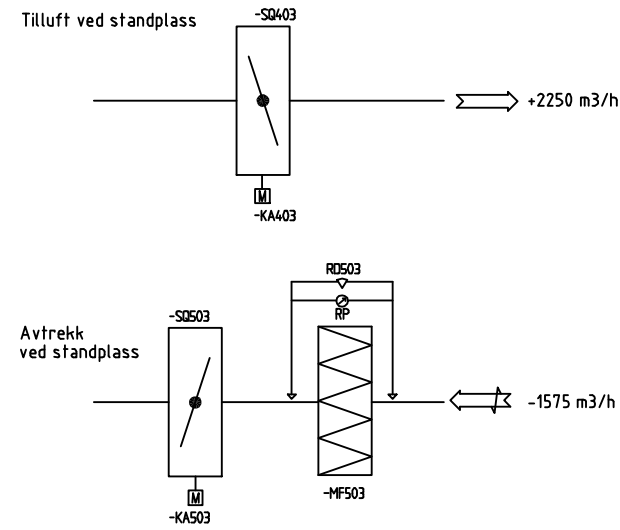

AVTREKK VED BLINK 1

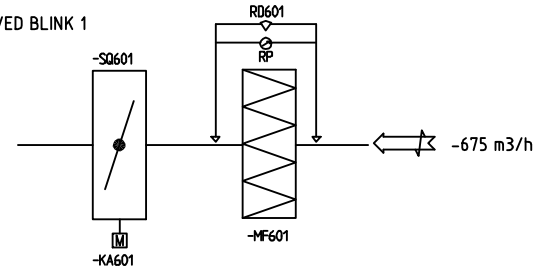

AVTREKK VED BLINK 2

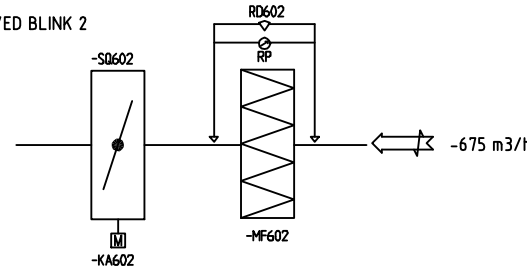

AVTREKK VED BLINK 3 (I ENDE AV KULVERT)

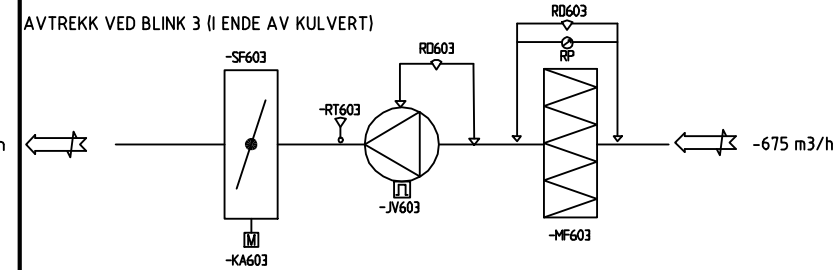

ØVRIGE AREALER

VENTILASJON I ØVRIGE AREALER

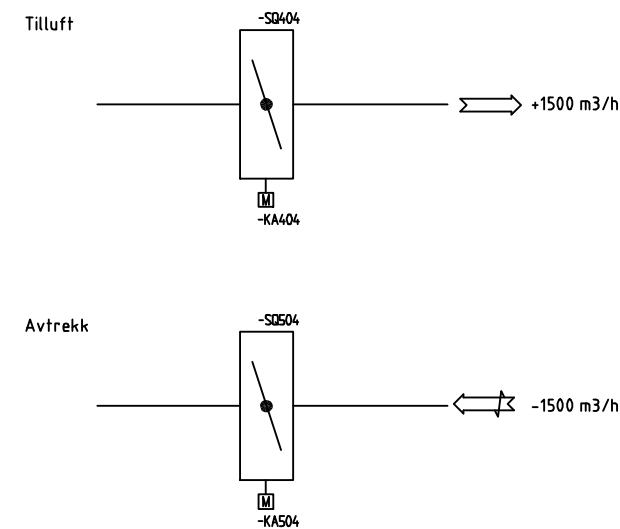

PUSSEROM

VENTILASJON SYSTEM: 360.002

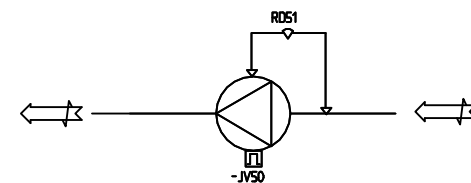

Status	Rev.	Endring	NDANDE	NOTTHY	NDKETT	06.06.2018
FFI						
Målestok: -			Format: A3			
Oppdragsleder: Anders R. Syverisen			Oppdragsnr.: 28322001			
FFI Lab Systemskjema ventilasjon (VAV)			Disiplin: V	Løpenummer: 00-360-V-70-002	Status: -	Rev.: -



SWECO Norge AS
Christiansgt. 290, 0333 OSLO
Tlf.: 87 12 80 00 Fax: 87 12 58 40

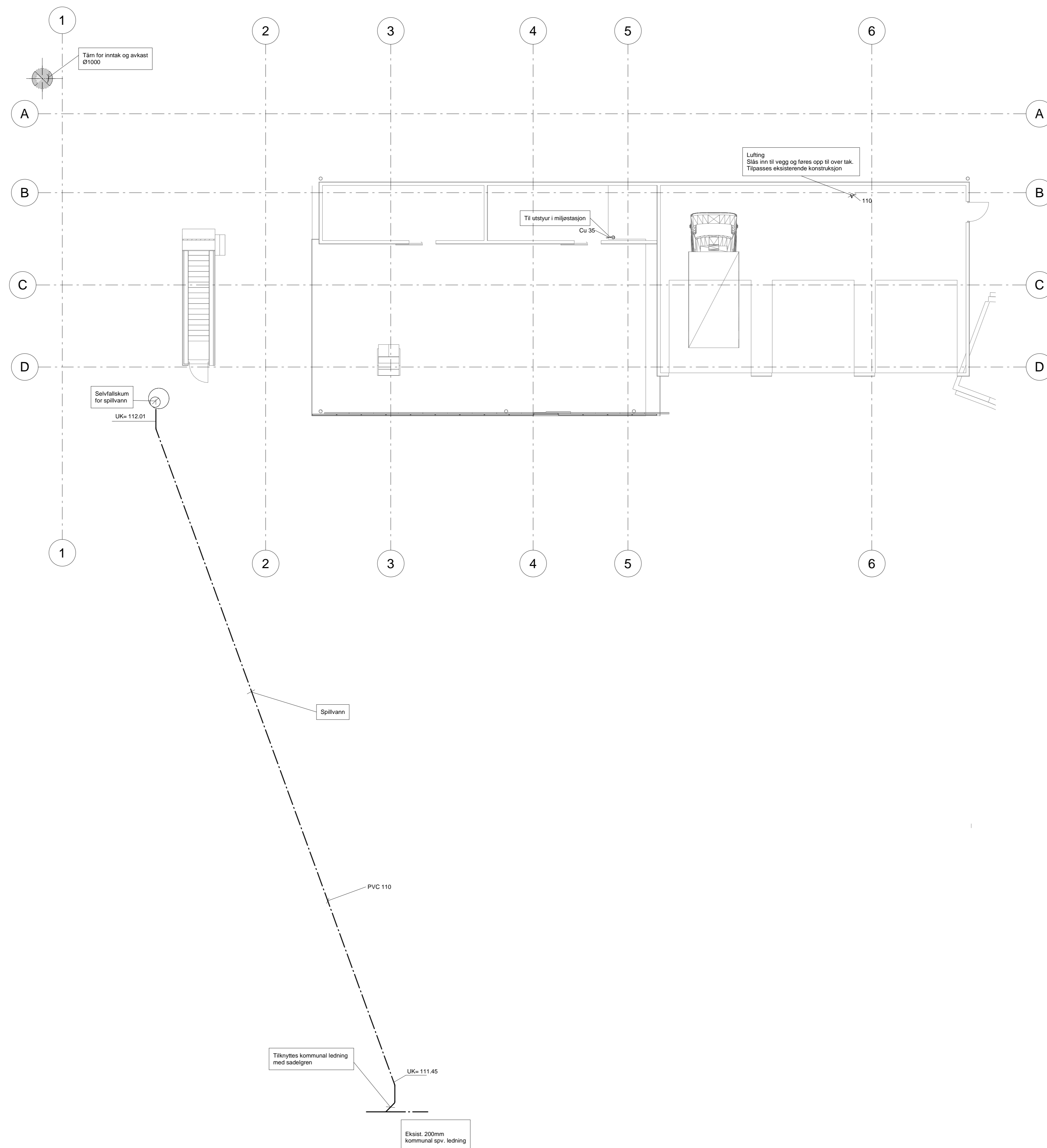

Tegningssett:	Tegningsstatus:
Utomhusplan	Tilbud
Dokumentnummer:	28322001 -V-01-300-V-10-001

Rev	Endring	Utf	Kont	Dato
Oppdragsleder		Libert or	Kont: or	
Forsvarsbygg		NOANDE	NOMARK	
Tegn		Dato	Revsering	
FFI Lab		03.05.2018	NOKETT	
Utomhusplan		Målestokk		
		Format	1:100	
		Sweco oppdragsnr.	28322001	
		Sweco oppdragsleder	NOANDE	
		Tegningsstatus	Tilbud	
Fagdisiplin	Tegningsnummer (bygge-fag-syst-type-toppnr)	Status	Rev.	
V	01-300-V-10-001			



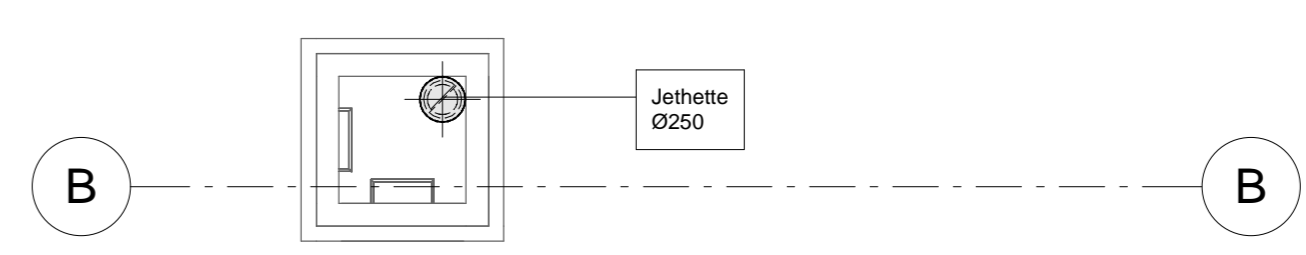
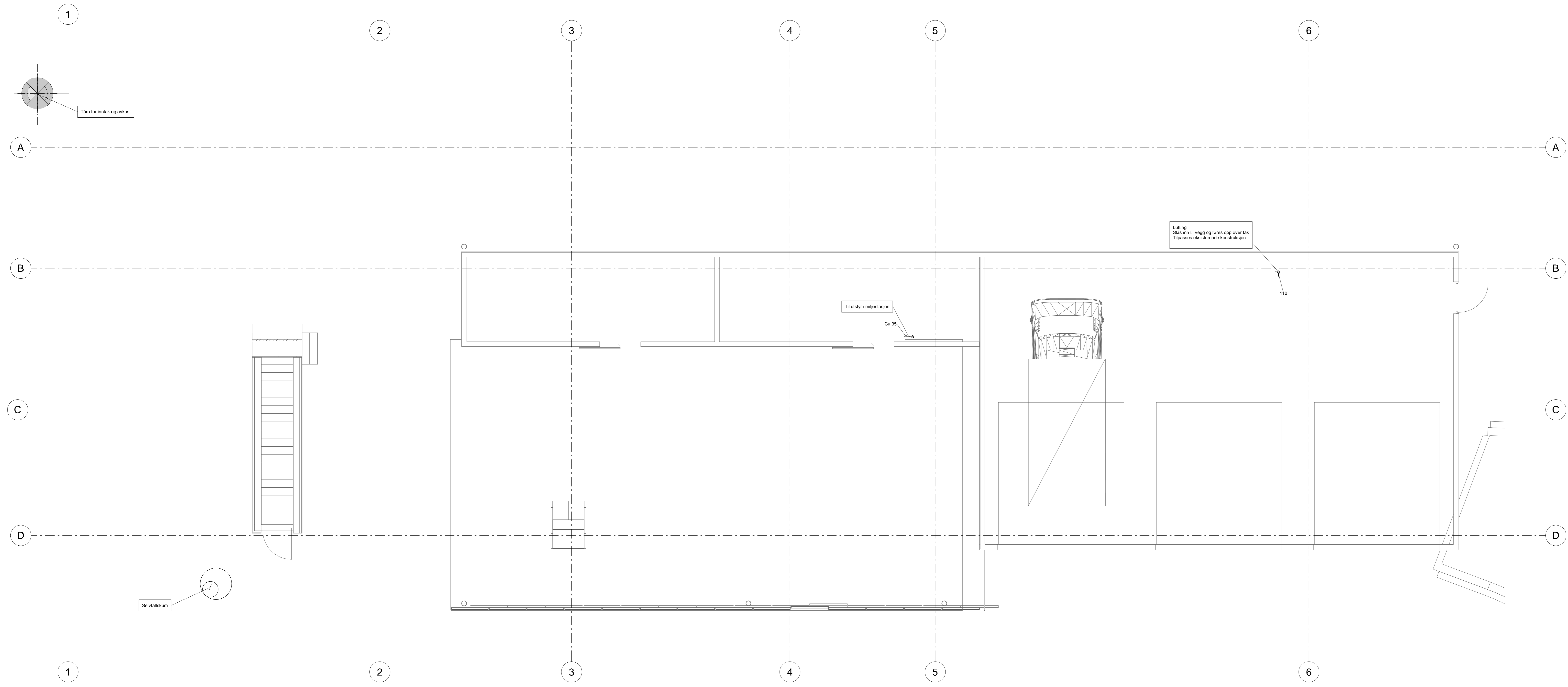

Tegningssett:	Tegningsstatus:
VVS Plan 01	Tilbud
Dokumentnummer: 28322001 -V-01-300-V-20-001	

Rev	Endring	Utt	Kontroll	Dato

Oppdragsleder	Utstedt av	Kontrollert av
Forsvarsbygg	NOANDE	NOTTMY
Tittel	Dato	Revisjon
FFI Lab	05.06.2018	NOCKETT
Målestokk	1:50	
Format	A0	
Sweco oppdragsnr.	28322001	
Sweco oppdragsleder	NOANDE	
Tegningsstatus	Tilbud	

Fagdisiplin	Tegningsnummer (bygge-fag-syst-type-tappnr)	Status	Rev.
V	01-300-V-20-001		

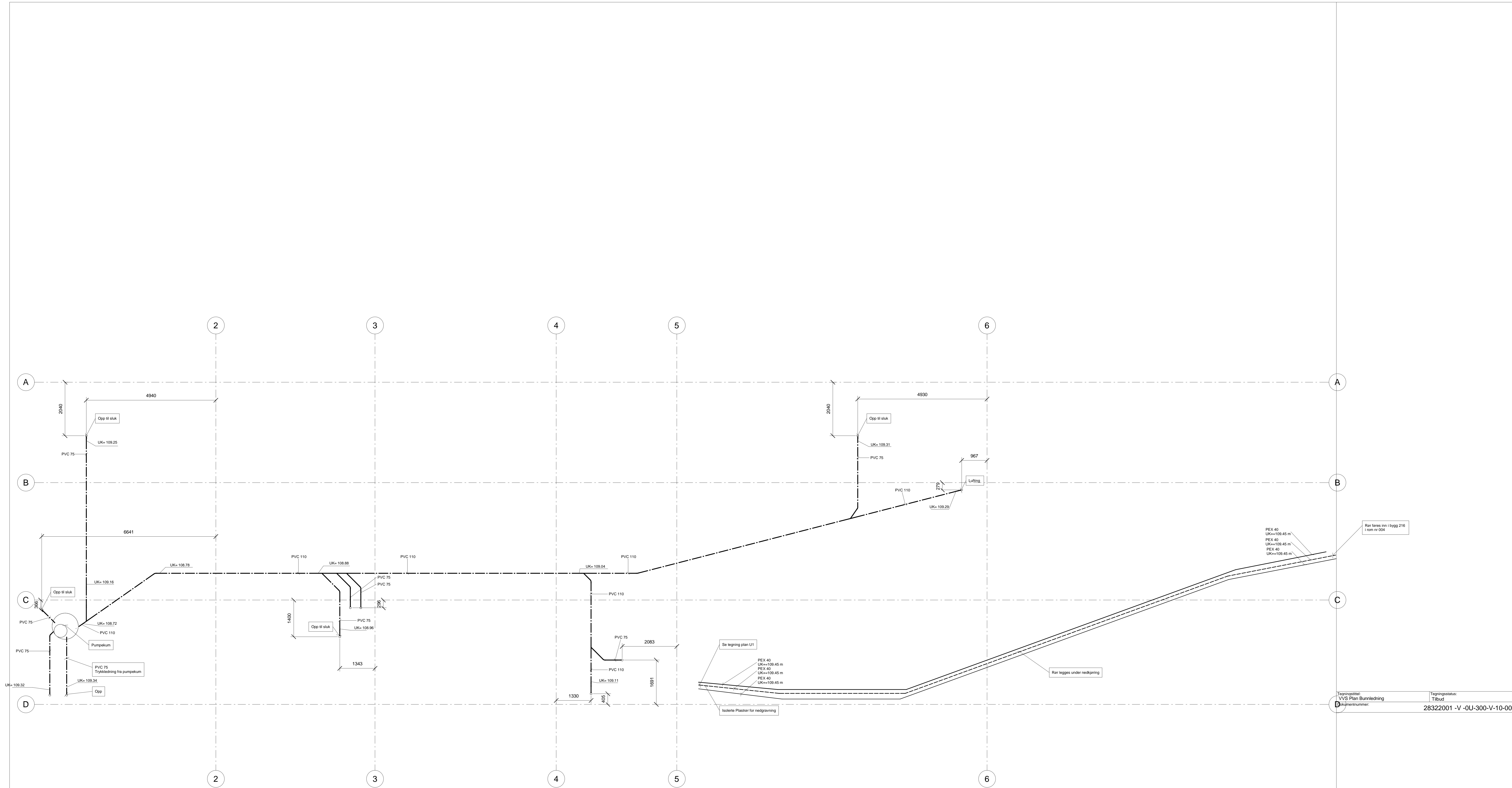

Tegningsstatus:	Tilbud
Prosjektnummer:	28322001 -V -0U-300-V-10-001

Rev	Endring	Utf	Kontroll	Dato

Oppdragsleder	Libertus	Kontrollør	NOANDE	NOANDE
Prosjektleder	Forsvarsbygg	Revurdering	NOTTMY	NOTTMY
Dato	05.06.2018	NOANDE	NOANDE	NOANDE
Målestokk	1:50			
Format	A0			
Sweco oppdragsnummer	28322001			
Sweco oppdragsleder	NOANDE			
Tegningsstatus	Tilbud			

Fagdisiplin	V	Tegningsnummer (bygge- og lag-syst-type-tappet)	0U-300-V-10-001	Status		Rev.	
-------------	---	---	-----------------	--------	--	------	--

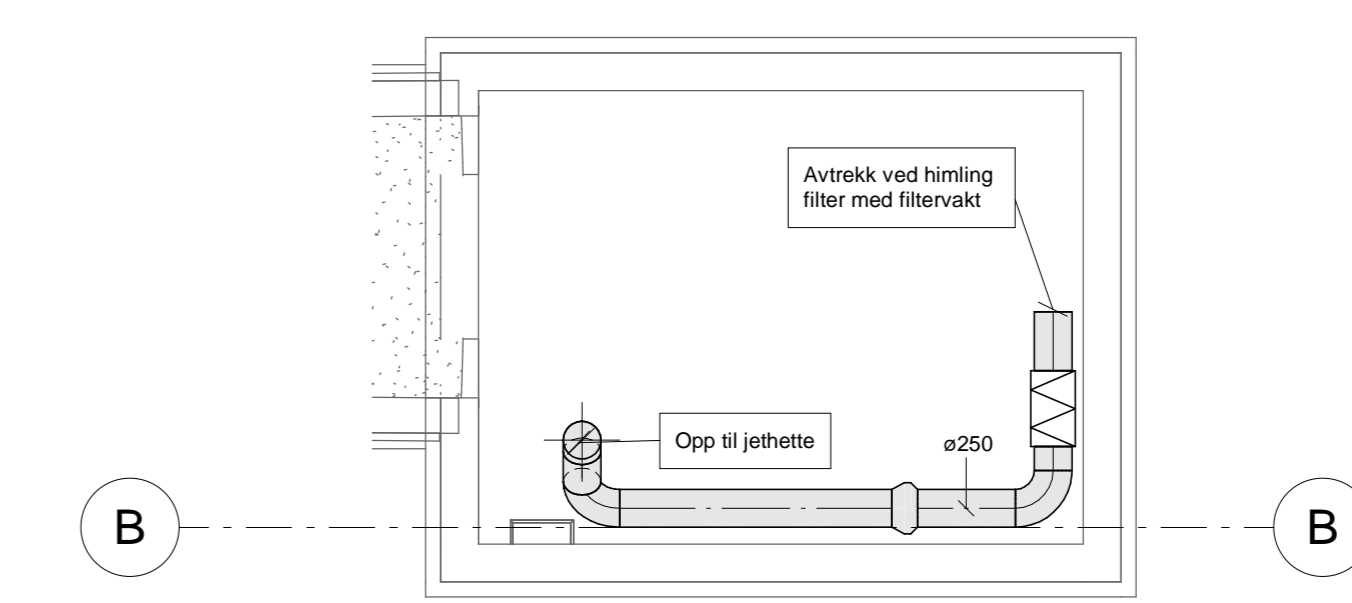
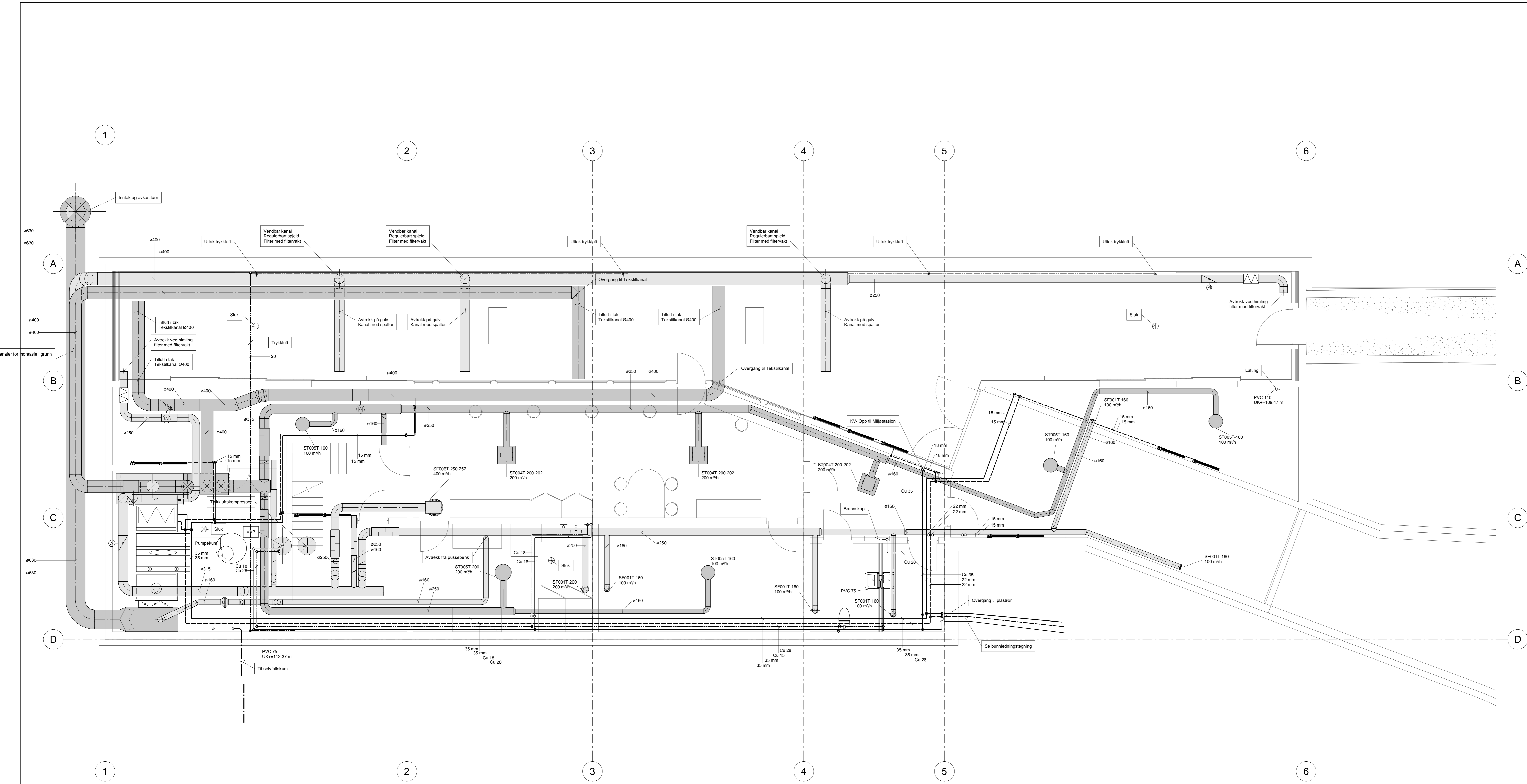

Rev	Ending	Utf	Kont	Dato
Oppdragsleder	Utskr	Utskr	Kont	Dato
Forsvarsbygg		Utskr		Dato
FFI Lab		Utskr		Dato
VVS Plan U1		Utskr		Dato

Oppdragsnummer	28322001	Tegningsstatus	Tilbud	
Dokumentnummer	28322001 - V -OU-300-V-20-001			
Rev	Ending	Utf	Kont	Dato
Oppdragsleder	Utskr	Utskr	Kont	Dato
Forsvarsbygg		Utskr		Dato
FFI Lab		Utskr		Dato
VVS Plan U1		Utskr		Dato
Format	A0			
Sweco oppdragsnummer	28322001			
Sweco oppdragsleder	Noande			
Tegningsstatus	Tilbud			
Fagdisiplin	V	Tegningsnummer (bygge- og lag-syst-type-tappet)	OU-300-V-20-001	
Status		Rev.		