

N:\516236\5166236\BIM\Landskap\Modell\5166236_Ands barnehage.dwg - SIAAu - Plottet: 2018-02-19 14:15:49 - LAYOUT = L100 - XREF = L_5166236_Prinnsnitt_1_kart 2d - RASTER = 2016_11_04_SKISSE_01.JPG

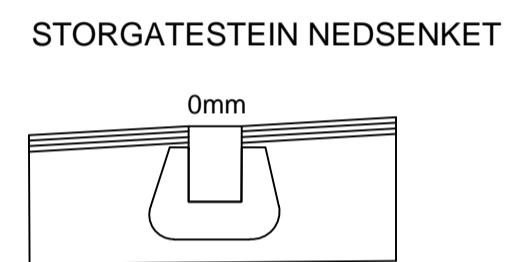

Storgatestein 140x140x200 mm
Settes i jordfugtig mørtel

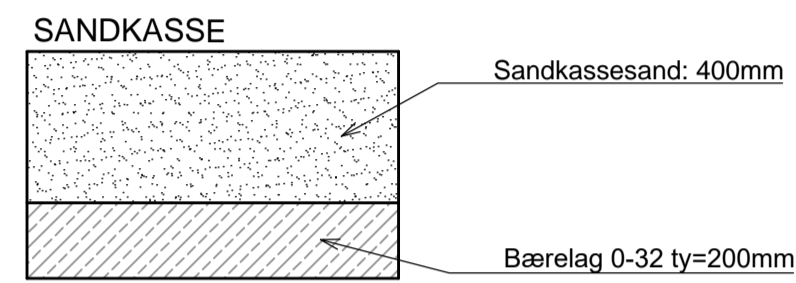
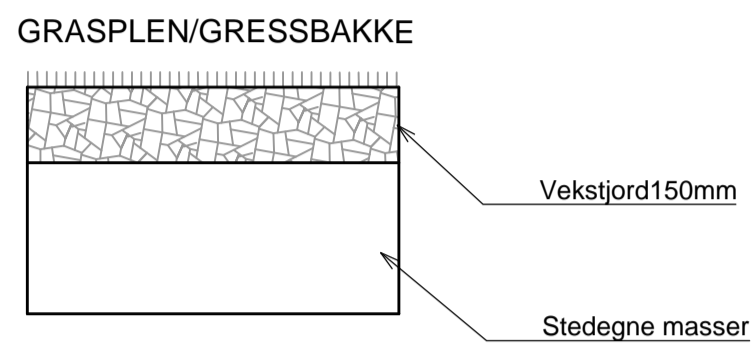
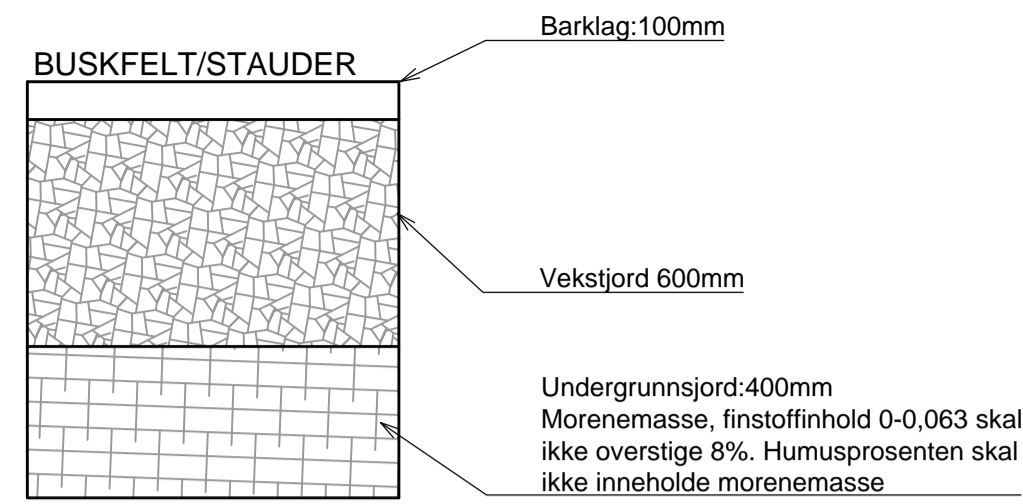
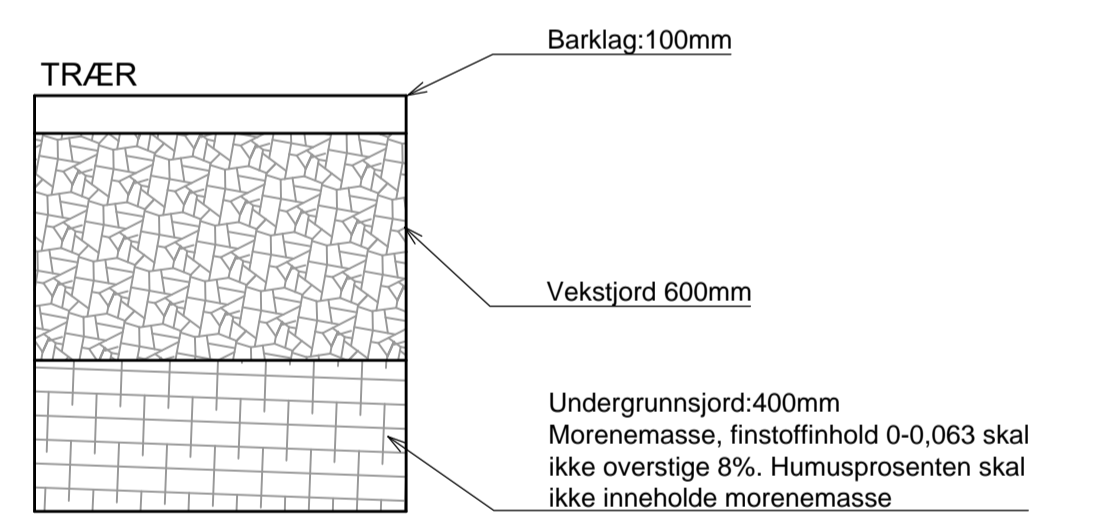
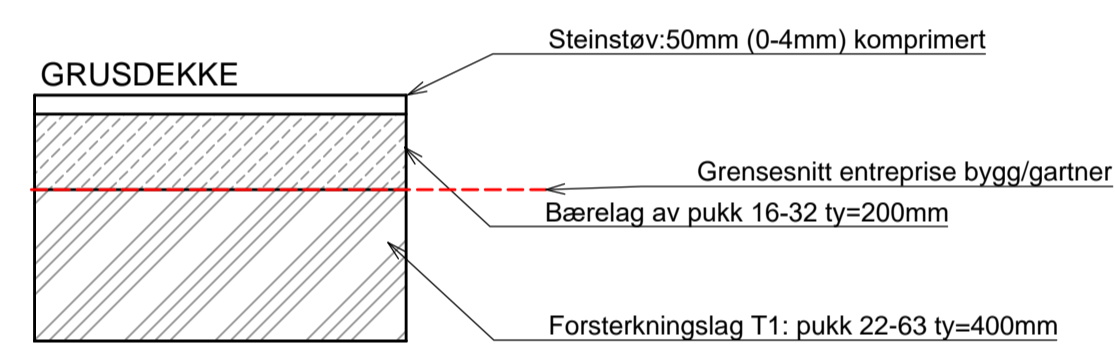
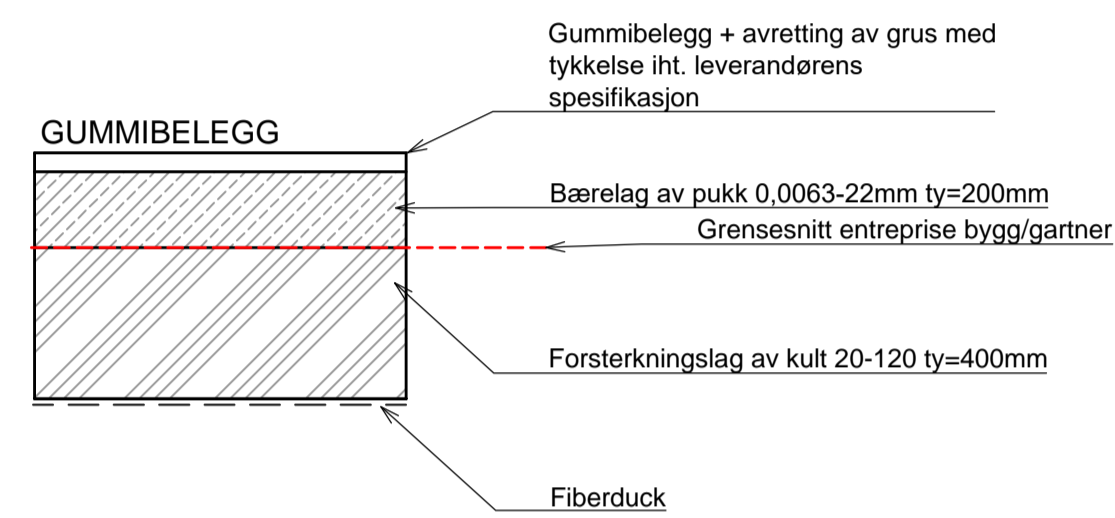
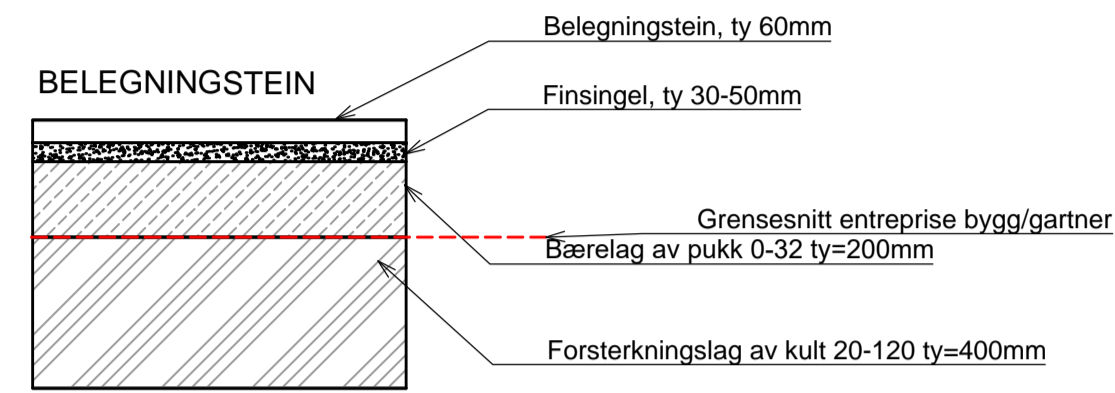
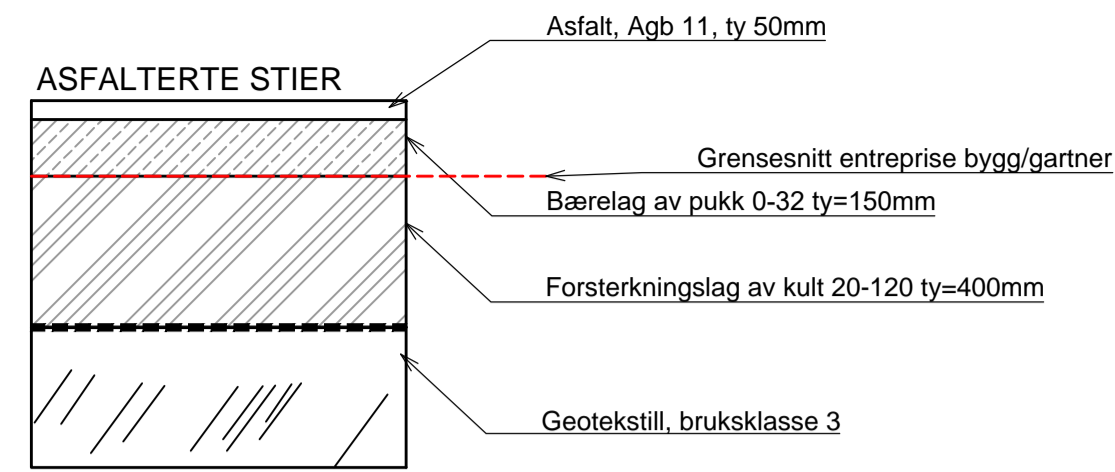
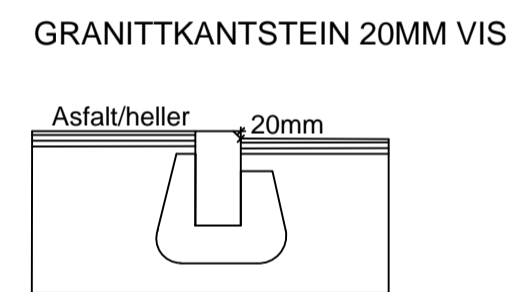

Granitkantstein settes i betongfundament

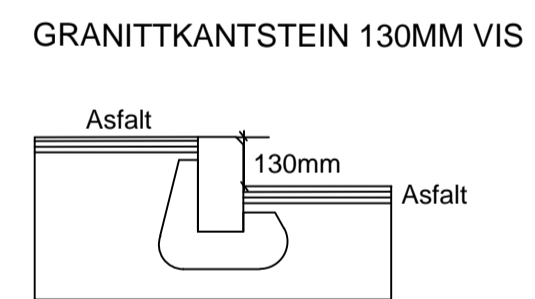

Granitkantstein settes i betongfundament

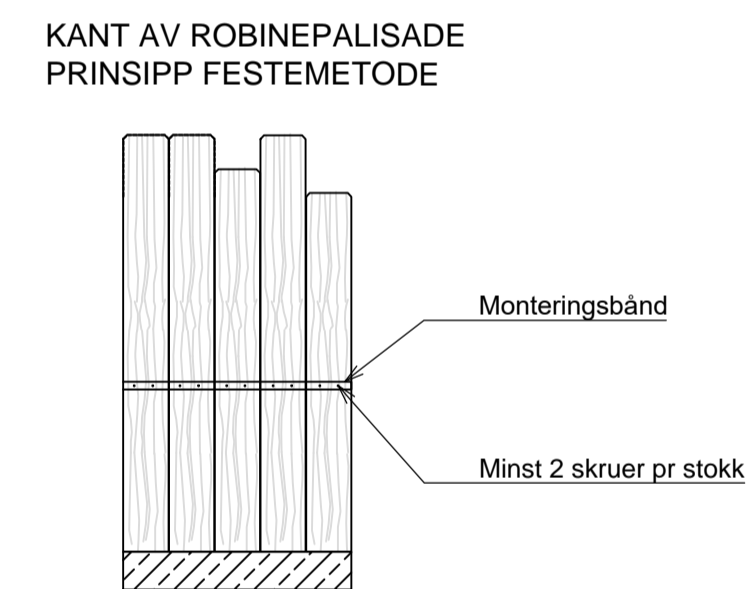
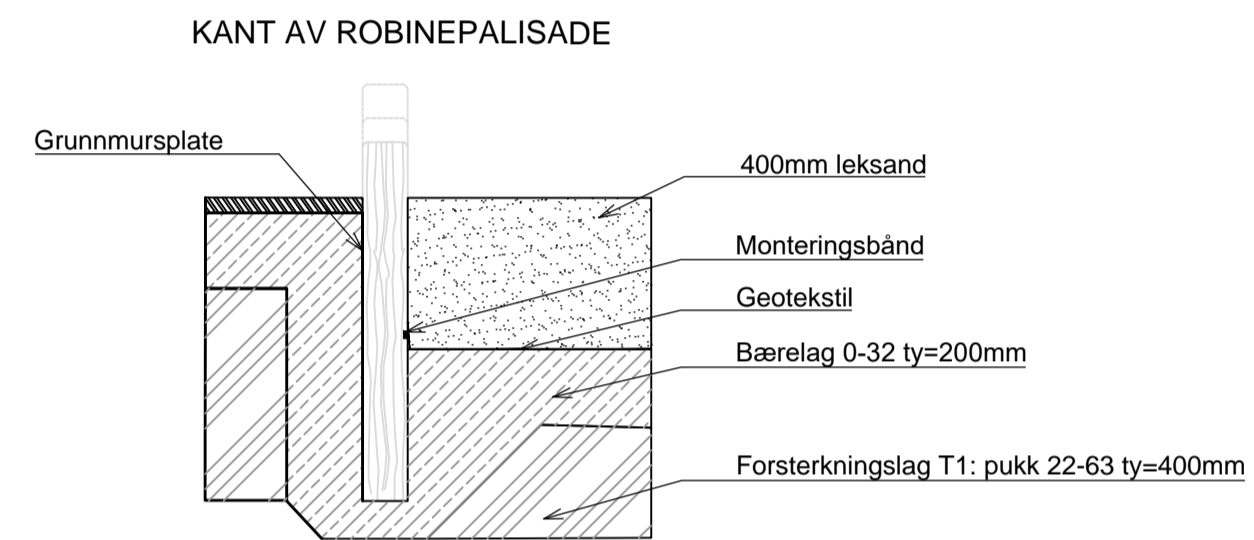
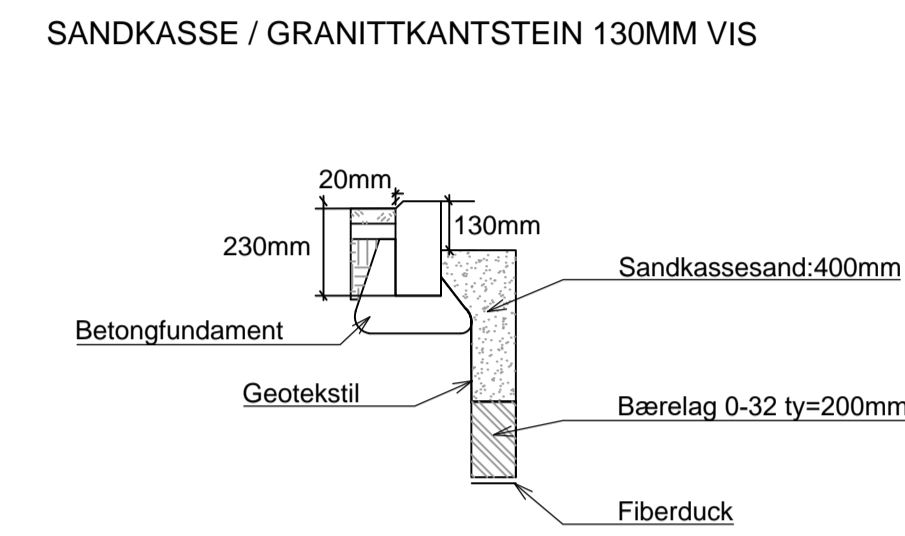
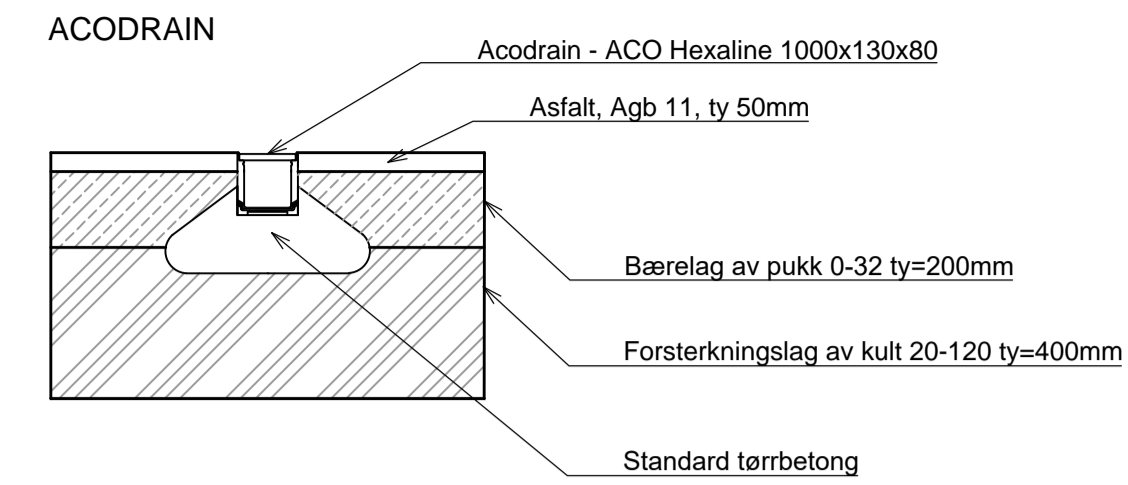

Tegningsnummer	Revisjon
L100	F01



Rev.	Dato	Beskrivelse	AnBud	SIAAu	SIAAu
			Utarbeidet	Fagkontroll	Godkjent

Dette dokumentet er utarbeidet av Norconsult AS som del av det oppdraget som fremgår nedenfor. Opphavsretten tilhører Norconsult AS. Dokumentet må bare benyttes til det formål som oppdragsavtalen beskriver, og må ikke kopieres eller gjøres tilgjengelig på annen måte eller i større utstrekning enn formålet tilsier.

Vefsn kommune	Målestokk (gjelder A1)
	1:20

Andås Barnehage
Snitt og detaljer

Norconsult	Oppdragsnummer	Tegningsnummer	Revisjon
	5166236	L100	F01