

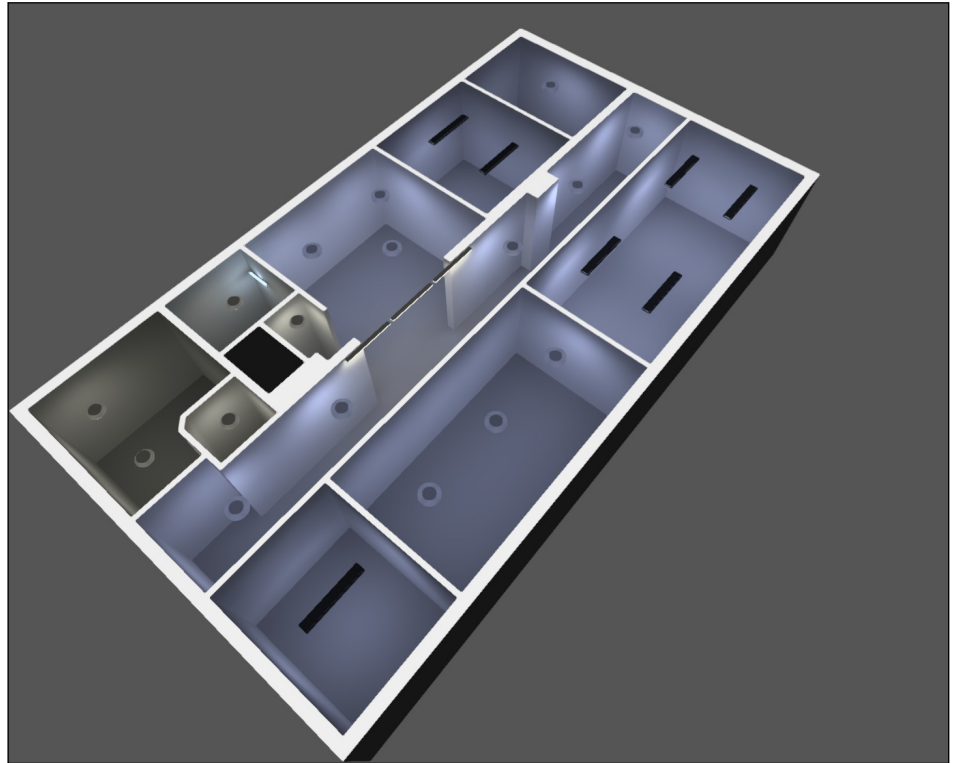









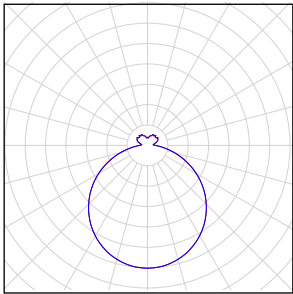

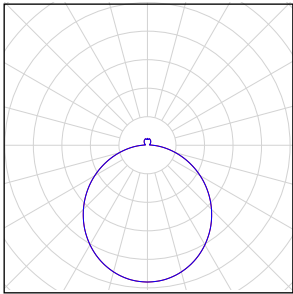
cq36

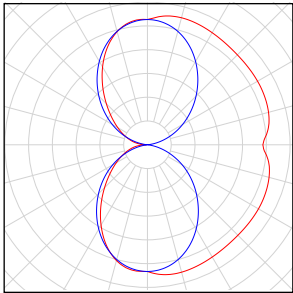

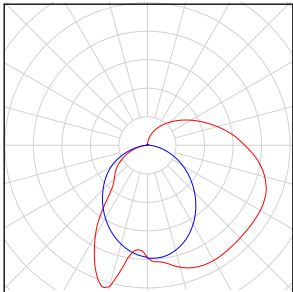
cq36

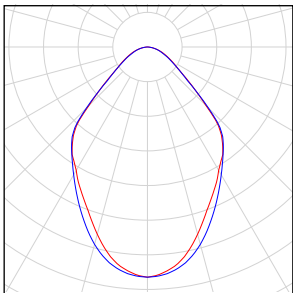
| Stykketall | Armatur (Lysutstråling) | | |
|------------|--|--|---|
| 5 | <p>Glamox Luxo Lighting - A10-S350 LED 1100 830</p> <p>Lysutstråling 1</p> <p>Bestykning: 1xLED A10 1800 830</p> <p>Absolutt fotometri</p> <p>Armaturlysstrøm: 1071 lm</p> <p>Effekt: 16.0 W</p> <p>Lysutbytte: 66.9 lm/W</p> <p>Fargemetriske opplysninger</p> <p>1xLED A10 1800 830: CCT 3259 K, CRI 80</p> |  |  |
| 12 | <p>Glamox Luxo Lighting - A20-S420 LED 2400 830</p> <p>Lysutstråling 1</p> <p>Bestykning: 1xLED A20-S 2400</p> <p>Absolutt fotometri</p> <p>Armaturlysstrøm: 2367 lm</p> <p>Effekt: 32.0 W</p> <p>Lysutbytte: 74.0 lm/W</p> <p>Fargemetriske opplysninger</p> <p>1xLED A20-S 2400: CCT 3000 K, CRI 84</p> |  |  |
| 1 | <p>Glamox Luxo Lighting - A40-W 114</p> <p>Lysutstråling 1</p> <p>Bestykning: 1xT5 14W HE</p> <p>Driftsvirkningsgrad: 74.19%</p> <p>Lampelysmengde: 1200 lm</p> <p>Armaturlysstrøm: 890 lm</p> <p>Effekt: 17.0 W</p> <p>Lysutbytte: 52.4 lm/W</p> <p>Fargemetriske opplysninger</p> <p>1xT5 14W HE: CCT 4033 K, CRI 80</p> |  |  |
| 3 | <p>Glamox Luxo Lighting - C10-W1174 LED 1800 830 CO</p> <p>Lysutstråling 1</p> <p>Bestykning: 1xLED TL43 1800 830</p> <p>Absolutt fotometri</p> <p>Armaturlysstrøm: 1760 lm</p> <p>Effekt: 16.0 W</p> <p>Lysutbytte: 110.0 lm/W</p> <p>Fargemetriske opplysninger</p> <p>1xLED TL43 1800 830: CCT 3259 K, CRI 80</p> |  |  |
| 2 | <p>Glamox Luxo Lighting - C20-S4 1200 LED 2000 840 MP</p> <p>Lysutstråling 1</p> <p>Bestykning: 1xLED C20-S4 2000</p> <p>Absolutt fotometri</p> <p>Armaturlysstrøm: 2115 lm</p> <p>Effekt: 18.0 W</p> <p>Lysutbytte: 117.5 lm/W</p> <p>Fargemetriske opplysninger</p> <p>1xLED C20-S4 2000: CCT 4000 K, CRI 84</p> |  |  |

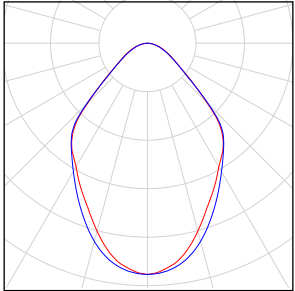
| Stykketall | Armaturlys (Lysutstråling) | | |
|------------|---|--|---|
| 5 | <p>Glamox Luxo Lighting - C20-S4 1200 LED 3000 840 MP Lysutstråling 1 Bestykning: 1xLED C20-S4 3000 Absolutt fotometri Armaturlysstrøm: 3032 lm Effekt: 26.0 W Lysutbytte: 116.6 lm/W</p> <p>Fargemetriske opplysninger 1xLED C20-S4 3000: CCT 4000 K, CRI 84</p> |  |  |

Samlet lampelysmengde: 59629 lm, Samlet armaturlysmengde: 59319 lm, Samlet effekt: 695.0 W, Lysutbytte: 85.4 lm/W

Areal 1

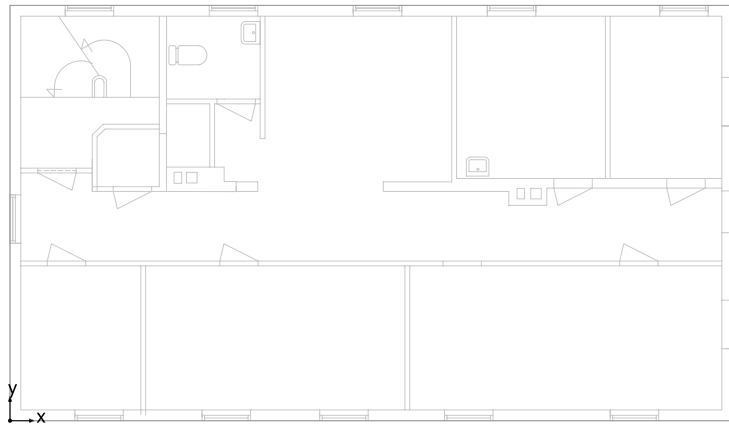

Trapp

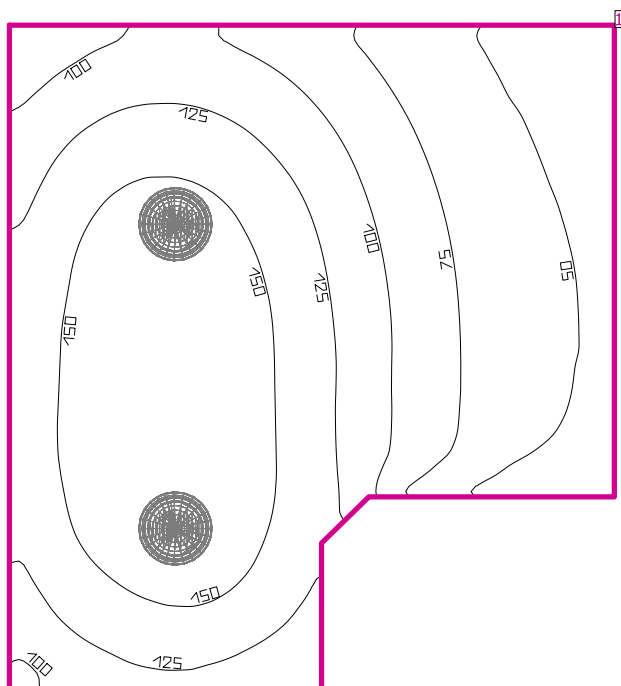

Takhøyde: 2.500 m, Refleksjonsfaktorer: Tak 70.0%, Vegger 50.0%, Gulv 20.0%, Forminskingsfaktor: 0.80

Arbeidsplan

| Flate | Resultat | Midlere (Nominell) | Min. | Maks. | Min./middels | Min./maks. |
|---------|---|--------------------|------|-------|--------------|------------|
| 1 Trapp | Perpendikulær belysningsstyrke (adaptiv) [lx] Høyde: 0.800 m, Yttergrense: 0.000 m | 112 (≥ 500) | 31.0 | 173 | 0.28 | 0.18 |

| # | Armatur | Φ (Armatur) [lm] | Effekt [W] | Lysutbytte [lm/W] |
|---|--|-----------------------|------------|-------------------|
| 2 | Glamox Luxo Lighting - A10-S350 LED 1100 830 | 1071 | 16.0 | 66.9 |
| | Sum over alle lamper | 2142 | 32.0 | 66.9 |

Spesifikk tilkoblingsverdi: 4.06 W/m² (Rommets grunnflate 7.88 m²)

Forbruk: 88 kWh/a av maksimalt 300 kWh/a

BK

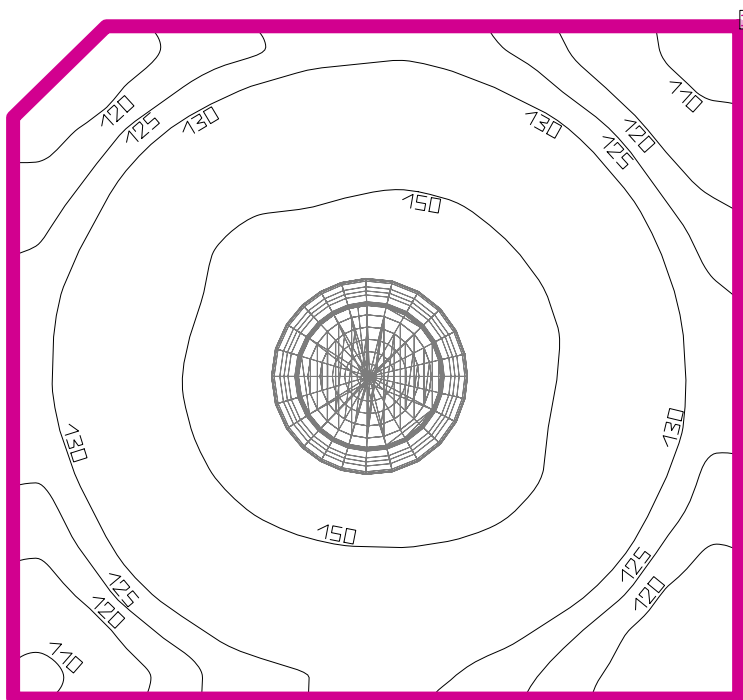

Takhøyde: 2.500 m, Refleksjonsfaktorer: Tak 70.0%, Vegger 50.0%, Gulv 20.0%, Forminskingsfaktor: 0.80

Arbeidsplan

| Flate | Resultat | Midlere (Nominell) | Min. | Maks. | Min./middels | Min./maks. |
|-------|--|--------------------|------|-------|--------------|------------|
| 1 BK | Perpendikulær belyningsstyrke (adaptiv) [lx] Høyde: 0.800 m, Yttergrense: 0.000 m | 137 (≥ 500) | 105 | 159 | 0.77 | 0.66 |

| # | Armatur | Φ (Armatur) [lm] | Effekt [W] | Lysutbytte [lm/W] |
|---|--|-----------------------|------------|-------------------|
| 1 | Glamox Luxo Lighting - A10-S350 LED 1100 830 | 1071 | 16.0 | 66.9 |
| | Sum over alle lamper | 1071 | 16.0 | 66.9 |

Spesifikk tilkoblingsverdi: 10.38 W/m² (Rommets grunnflate 1.54 m²)

Forbruk: 44 kWh/a av maksimalt 100 kWh/a

BK

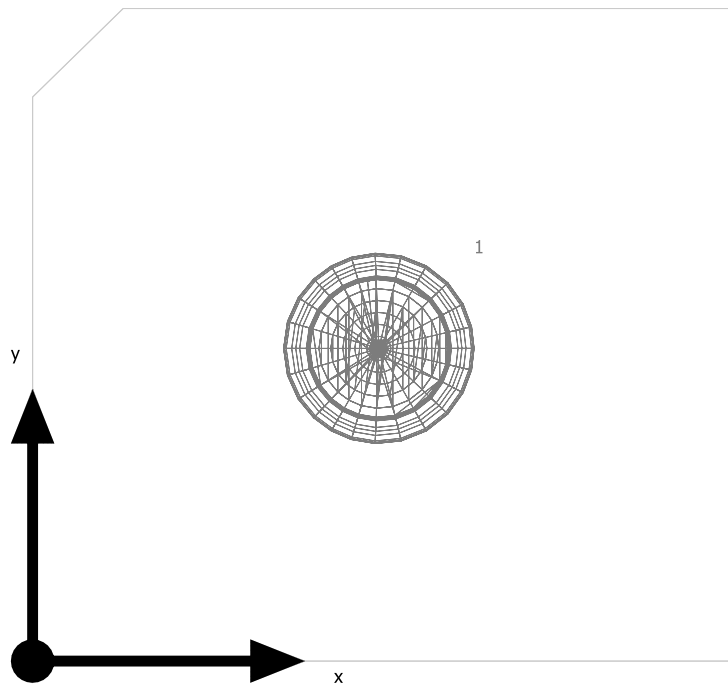

Glamox Luxo Lighting A10-S350 LED 1100 830

| Nr. | X [m] | Y [m] | Montasjehøyde [m] |
|-----|-------|-------|-------------------|
| 1 | 0.636 | 0.575 | 2.500 |

Wc

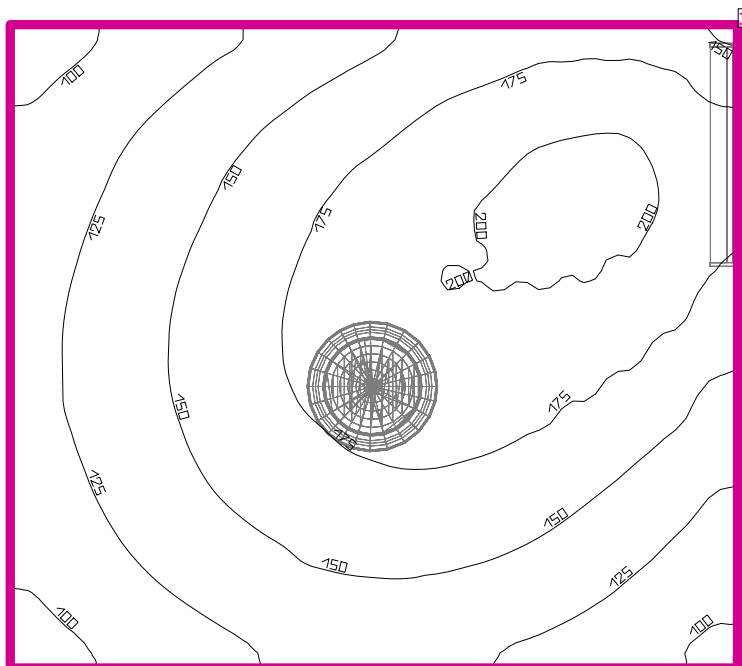

Takhøyde: 2.500 m, Refleksjonsfaktorer: Tak 70.0%, Vegger 50.0%, Gulv 20.0%, Forminskingsfaktor: 0.80

Arbeidsplan

| Flate | Resultat | Midlere (Nominell) | Min. | Maks. | Min./middels | Min./maks. |
|-------|--|--------------------|------|-------|--------------|------------|
| 1 Wc | Perpendikulær belyningsstyrke (adaptiv) [lx] Høyde: 0.800 m, Yttergrense: 0.000 m | 154 (≥ 500) | 87.8 | 208 | 0.57 | 0.42 |

| # | Armatur | Φ(Armatur) [lm] | Effekt [W] | Lysutbytte [lm/W] |
|---|--|-----------------|------------|-------------------|
| 1 | Glamox Luxo Lighting - A10-S350 LED 1100 830 | 1071 | 16.0 | 66.9 |
| 1 | Glamox Luxo Lighting - A40-W 114 | 890 | 17.0 | 52.4 |
| | Sum over alle lamper | 1961 | 33.0 | 59.4 |

Spesifikk tilkoblingsverdi: 9.81 W/m² (Rommets grunnflate 3.36 m²)

Forbruk: 91 kWh/a av maksimalt 150 kWh/a

Wc

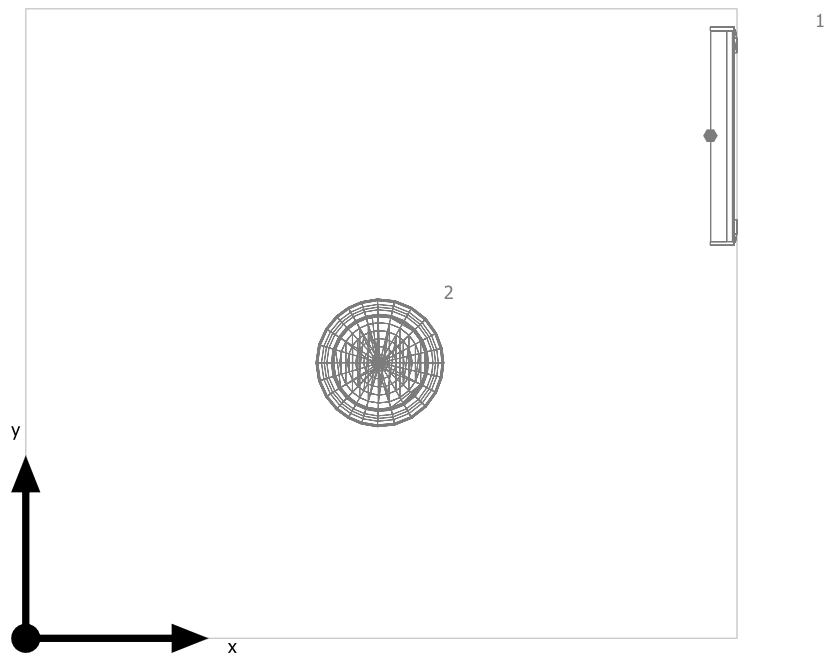

Glamox Luxo Lighting A40-W 114

| Nr. | X [m] | Y [m] | Montasjehøyde [m] |
|-----|-------|-------|-------------------|
| 1 | 1.950 | 1.376 | 1.800 |

Glamox Luxo Lighting A10-S350 LED 1100 830

| Nr. | X [m] | Y [m] | Montasjehøyde [m] |
|-----|-------|-------|-------------------|
| 2 | 0.971 | 0.755 | 2.500 |

Rom 15

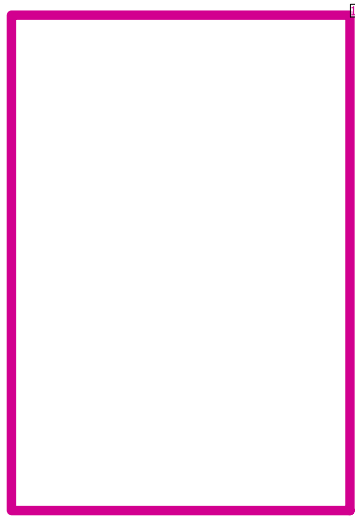

Takhøyde: 2.500 m, Refleksjonsfaktorer: Tak 70.0%, Vegger 50.0%, Gulv 20.0%, Forminskingsfaktor: 0.80

Arbeidsplan

| Flate | Resultat | Midlere (Nominell) | Min. | Maks. | Min./middels | Min./maks. |
|------------------|---|---------------------|------|-------|--------------|------------|
| 1 Arbeidsplan 15 | Perpendikulær belysningsstyrke (adaptiv) [lx] Høyde: 0.800 m, Yttergrense: 0.000 m | 0.00 (≥ 500) | 0.00 | 0.00 | / | / |

Spesifikk tilkoblingsverdi: 0.00 W/m² (Rommets grunnflate 1.19 m²)

Forbruk: 0 kWh/a av maksimalt 50 kWh/a

Sosial og gang

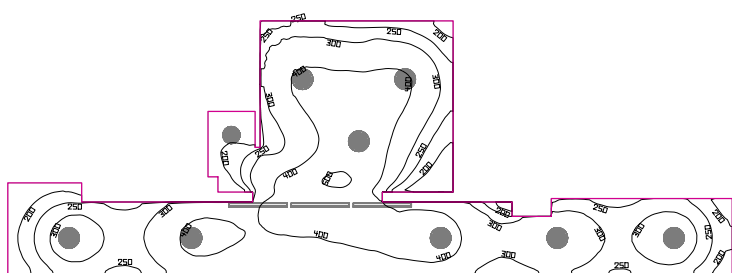

Takhøyde: 2.500 m, Refleksjonsfaktorer: Tak 70.0%, Vegger 50.0%, Gulv 20.0%, Forminskingsfaktor: 0.80

Arbeidsplan

| Flate | Resultat | Midlere (Nominell) | Min. | Maks. | Min./middels | Min./maks. |
|------------------|---|--------------------|------|-------|--------------|------------|
| 1 Sosial og gang | Perpendikulær belysningsstyrke (adaptiv) [lx] Høyde: 0.800 m, Yttergrense: 0.000 m | 333 (≥ 500) | 123 | 513 | 0.37 | 0.24 |

| # | Armatur | Φ(Armatur) [lm] | Effekt [W] | Lysutbytte [lm/W] |
|---|--|-----------------|------------|-------------------|
| 1 | Glamox Luxo Lighting - A10-S350 LED 1100 830 | 1071 | 16.0 | 66.9 |
| 8 | Glamox Luxo Lighting - A20-S420 LED 2400 830 | 2367 | 32.0 | 74.0 |
| 3 | Glamox Luxo Lighting - C10-W1174 LED 1800 830 CO | 1760 | 16.0 | 110.0 |
| | Sum over alle lamper | 25287 | 320.0 | 79.0 |

Spesifikk tilkoblingsverdi: 8.58 W/m² (Rommets grunnflate 37.28 m²)

Forbruk: 880 kWh/a av maksimalt 1350 kWh/a

Sosial og gang

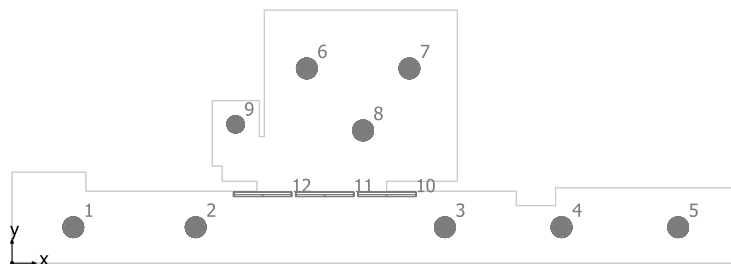

Glamox Luxo Lighting A20-S420 LED 2400 830

| Nr. | X [m] | Y [m] | Montasjehøyde [m] |
|-----|--------|-------|-------------------|
| 1 | 1.234 | 0.725 | 2.500 |
| 2 | 3.701 | 0.725 | 2.500 |
| 3 | 8.725 | 0.725 | 2.500 |
| 4 | 11.075 | 0.725 | 2.500 |
| 5 | 13.425 | 0.725 | 2.500 |
| 6 | 5.941 | 3.925 | 2.500 |
| 7 | 8.009 | 3.925 | 2.500 |
| 8 | 7.075 | 2.675 | 2.500 |

Glamox Luxo Lighting A10-S350 LED 1100 830

| Nr. | X [m] | Y [m] | Montasjehøyde [m] |
|-----|-------|-------|-------------------|
| 9 | 4.506 | 2.799 | 2.500 |

Glamox Luxo Lighting C10-W1174 LED 1800 830 CO

| Nr. | X [m] | Y [m] | Montasjehøyde [m] |
|-----|-------|-------|-------------------|
| 10 | 7.550 | 1.432 | 2.450 |
| 11 | 6.299 | 1.432 | 2.450 |
| 12 | 5.049 | 1.432 | 2.450 |

Hobby

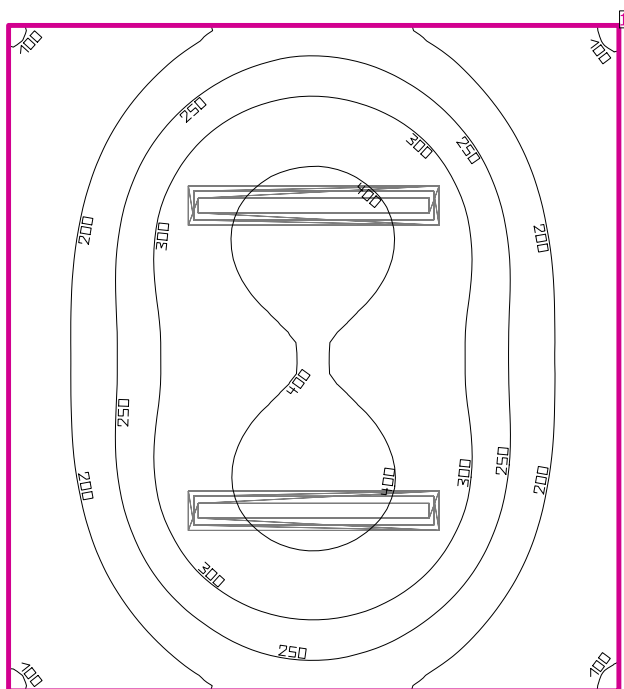

Takhøyde: 2.500 m, Refleksjonsfaktorer: Tak 70.0%, Vegger 50.0%, Gulv 20.0%, Forminskingsfaktor: 0.80

Arbeidsplan

| Flate | Resultat | Midlere (Nominell) | Min. | Maks. | Min./middels | Min./maks. |
|---------|---|--------------------|------|-------|--------------|------------|
| 1 Hobby | Perpendikulær belysningsstyrke (adaptiv) [lx] Høyde: 0.800 m, Yttergrense: 0.000 m | 262 (≥ 500) | 94.7 | 449 | 0.36 | 0.21 |

| # | Armatur | Φ (Armatur) [lm] | Effekt [W] | Lysutbytte [lm/W] |
|---|--|-----------------------|------------|-------------------|
| 2 | Glamox Luxo Lighting - C20-S4 1200 LED 2000 840 MP | 2115 | 18.0 | 117.5 |
| | Sum over alle lamper | 4230 | 36.0 | 117.5 |

Spesifikk tilkoblingsverdi: 3.44 W/m² (Rommets grunnflate 10.48 m²)

Forbruk: 99 kWh/a av maksimalt 400 kWh/a

Hobby

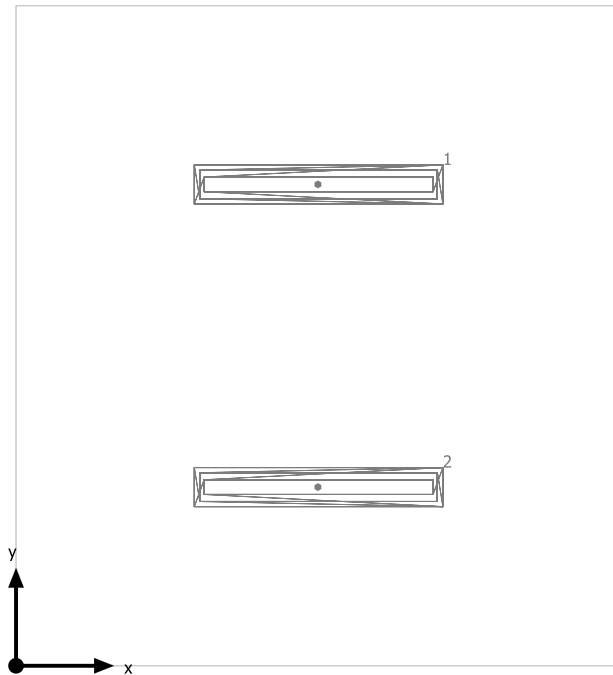

Glamox Luxo Lighting C20-S4 1200 LED 2000 840 MP

| Nr. | X [m] | Y [m] | Montasjehøyde [m] |
|-----|-------|-------|-------------------|
| 1 | 1.550 | 2.465 | 2.500 |
| 2 | 1.550 | 0.915 | 2.500 |

Samtale

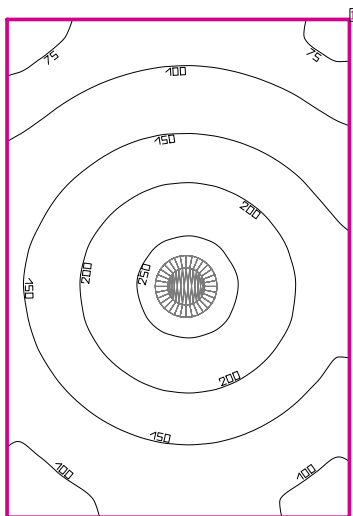

Takhøyde: 2.500 m, Refleksjonsfaktorer: Tak 70.0%, Vegger 50.0%, Gulv 20.0%, Forminskingsfaktor: 0.80

Arbeidsplan

| Flate | Resultat | Midlere (Nominell) | Min. | Maks. | Min./middels | Min./maks. |
|-----------|--|--------------------|------|-------|--------------|------------|
| 1 Samtale | Perpendikulær belyningsstyrke (adaptiv) [lx] Høyde: 0.800 m, Yttergrense: 0.000 m | 152 (≥ 500) | 64.6 | 269 | 0.43 | 0.24 |

| # | Armatur | Φ(Armatur) [lm] | Effekt [W] | Lysutbytte [lm/W] |
|---|--|-----------------|------------|-------------------|
| 1 | Glamox Luxo Lighting - A20-S420 LED 2400 830 | 2367 | 32.0 | 74.0 |
| | Sum over alle lamper | 2367 | 32.0 | 74.0 |

Spesifikk tilkoblingsverdi: 4.07 W/m² (Rommets grunnflate 7.86 m²)

Forbruk: 88 kWh/a av maksimalt 300 kWh/a

Samtale

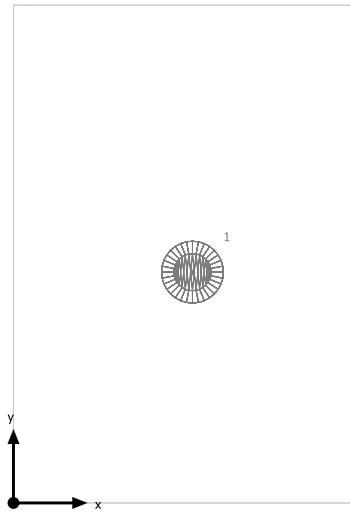

Glamox Luxo Lighting A20-S420 LED 2400 830

| Nr. | X [m] | Y [m] | Montasjehøyde [m] |
|-----|-------|-------|-------------------|
| 1 | 1.216 | 1.567 | 2.500 |

Aktivitet

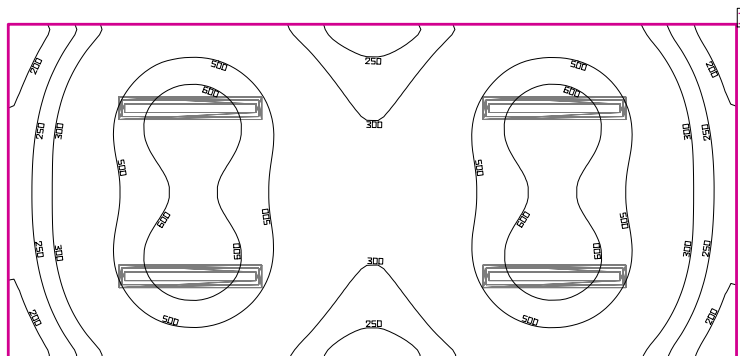

Takhøyde: 2.500 m, Refleksjonsfaktorer: Tak 70.0%, Vegger 50.0%, Gulv 20.0%, Forminskingsfaktor: 0.80

Arbeidsplan

| Flate | Resultat | Midlere (Nominell) | Min. | Maks. | Min./middels | Min./maks. |
|-------------|--|--------------------|------|-------|--------------|------------|
| 1 Aktivitet | Perpendikulær belyningsstyrke (adaptiv) [lx] Høyde: 0.800 m, Yttergrense: 0.000 m | 416 (≥ 500) | 152 | 676 | 0.37 | 0.22 |

| # | Armatur | Φ (Armatur) [lm] | Effekt [W] | Lysutbytte [lm/W] |
|---|--|-----------------------|------------|-------------------|
| 4 | Glamox Luxo Lighting - C20-S4 1200 LED 3000 840 MP | 3032 | 26.0 | 116.6 |
| | Sum over alle lamper | 12128 | 104.0 | 116.6 |

Spesifikk tilkoblingsverdi: 5.33 W/m² (Rommets grunnflate 19.50 m²)

Forbruk: 290 kWh/a av maksimalt 700 kWh/a

Aktivitet

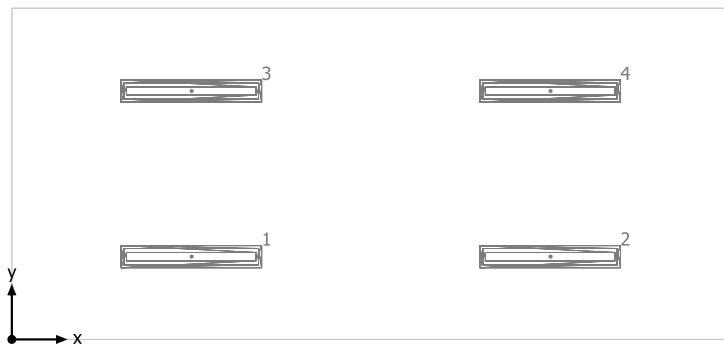

Glamox Luxo Lighting C20-S4 1200 LED 3000 840 MP

| Nr. | X [m] | Y [m] | Montasjehøyde [m] |
|-----|-------|-------|-------------------|
| 1 | 1.625 | 0.750 | 2.500 |
| 2 | 4.875 | 0.750 | 2.500 |
| 3 | 1.625 | 2.250 | 2.500 |
| 4 | 4.875 | 2.250 | 2.500 |

Sosial 2

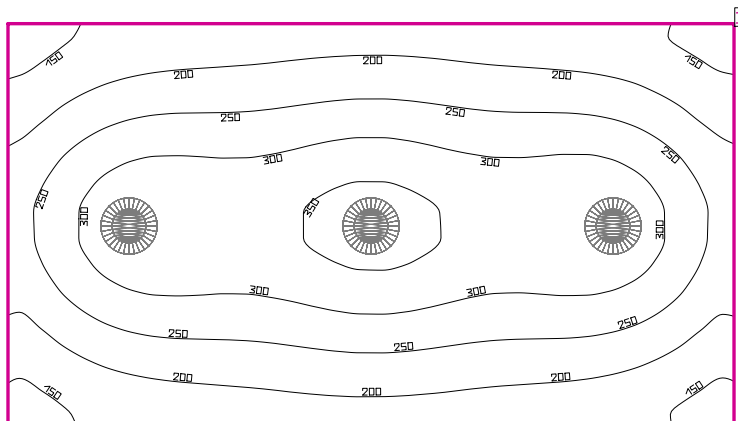

Takhøyde: 2.500 m, Refleksjonsfaktorer: Tak 70.0%, Vegger 50.0%, Gulv 20.0%, Forminskingsfaktor: 0.80

Arbeidsplan

| Flate | Resultat | Midlere (Nominell) | Min. | Maks. | Min./middels | Min./maks. |
|------------|---|--------------------|------|-------|--------------|------------|
| 1 Sosial 2 | Perpendikulær belysningsstyrke (adaptiv) [lx] Høyde: 0.800 m, Yttergrense: 0.000 m | 251 (≥ 500) | 127 | 369 | 0.51 | 0.34 |

| # | Armatur | Φ(Armatur) [lm] | Effekt [W] | Lysutbytte [lm/W] |
|---|--|-----------------|------------|-------------------|
| 3 | Glamox Luxo Lighting - A20-S420 LED 2400 830 | 2367 | 32.0 | 74.0 |
| | Sum over alle lamper | 7101 | 96.0 | 74.0 |

Spesifikk tilkoblingsverdi: 5.93 W/m² (Rommets grunnflate 16.20 m²)

Forbruk: 260 kWh/a av maksimalt 600 kWh/a

Sosial 2

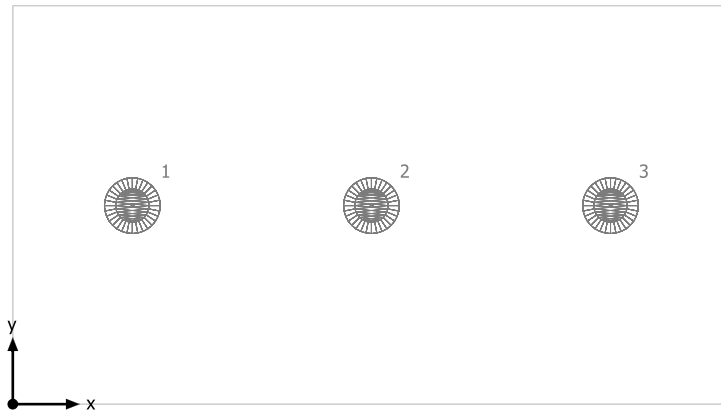

Glamox Luxo Lighting A20-S420 LED 2400 830

| Nr. | X [m] | Y [m] | Montasjehøyde [m] |
|-----|-------|-------|-------------------|
| 1 | 0.900 | 1.495 | 2.500 |
| 2 | 2.700 | 1.495 | 2.500 |
| 3 | 4.500 | 1.495 | 2.500 |

Kontor

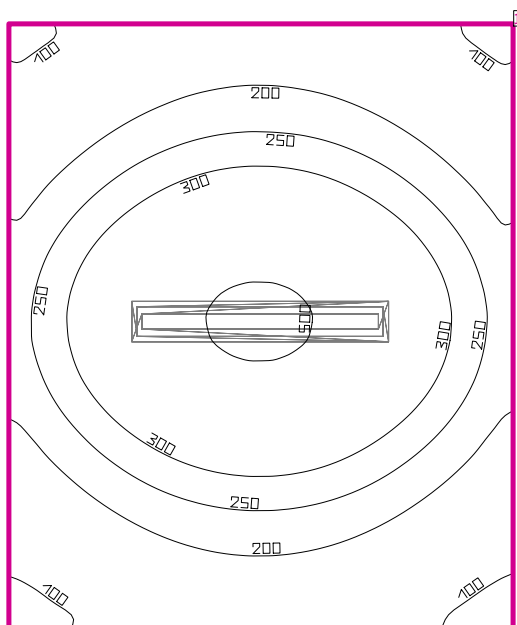

Takhøyde: 2.500 m, Refleksjonsfaktorer: Tak 70.0%, Vegger 50.0%, Gulv 20.0%, Forminskingsfaktor: 0.80

Arbeidsplan

| Flate | Resultat | Midlere (Nominell) | Min. | Maks. | Min./middels | Min./maks. |
|-------|--|--------------------|------|-------|--------------|------------|
| 1 | Kontor Perpendikulær belysningsstyrke (adaptiv) [lx] Høyde: 0.800 m, Yttergrense: 0.000 m | 255 (≥ 500) | 80.4 | 526 | 0.32 | 0.15 |

| # | Armatur | Φ (Armatur) [lm] | Effekt [W] | Lysutbytte [lm/W] |
|---|--|-----------------------|------------|-------------------|
| 1 | Glamox Luxo Lighting - C20-S4 1200 LED 3000 840 MP | 3032 | 26.0 | 116.6 |
| | Sum over alle lamper | 3032 | 26.0 | 116.6 |

Spesifikk tilkoblingsverdi: 3.47 W/m² (Rommets grunnflate 7.50 m²)

Forbruk: 72 kWh/a av maksimalt 300 kWh/a

Kontor

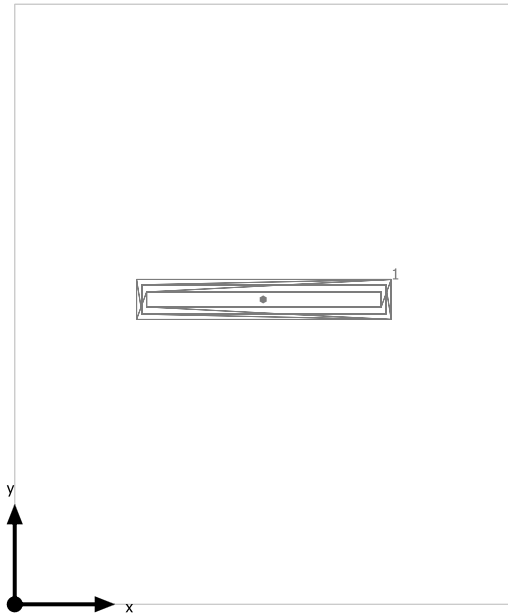

Glamox Luxo Lighting C20-S4 1200 LED 3000 840 MP

| Nr. | X [m] | Y [m] | Montasjehøyde [m] |
|-----|-------|-------|-------------------|
| 1 | 1.246 | 1.524 | 2.500 |