

Plan 5
+45.300

Plan 5
453(+45.300)

Plan 4
+43.300

MePlan 4
433(+43.300)

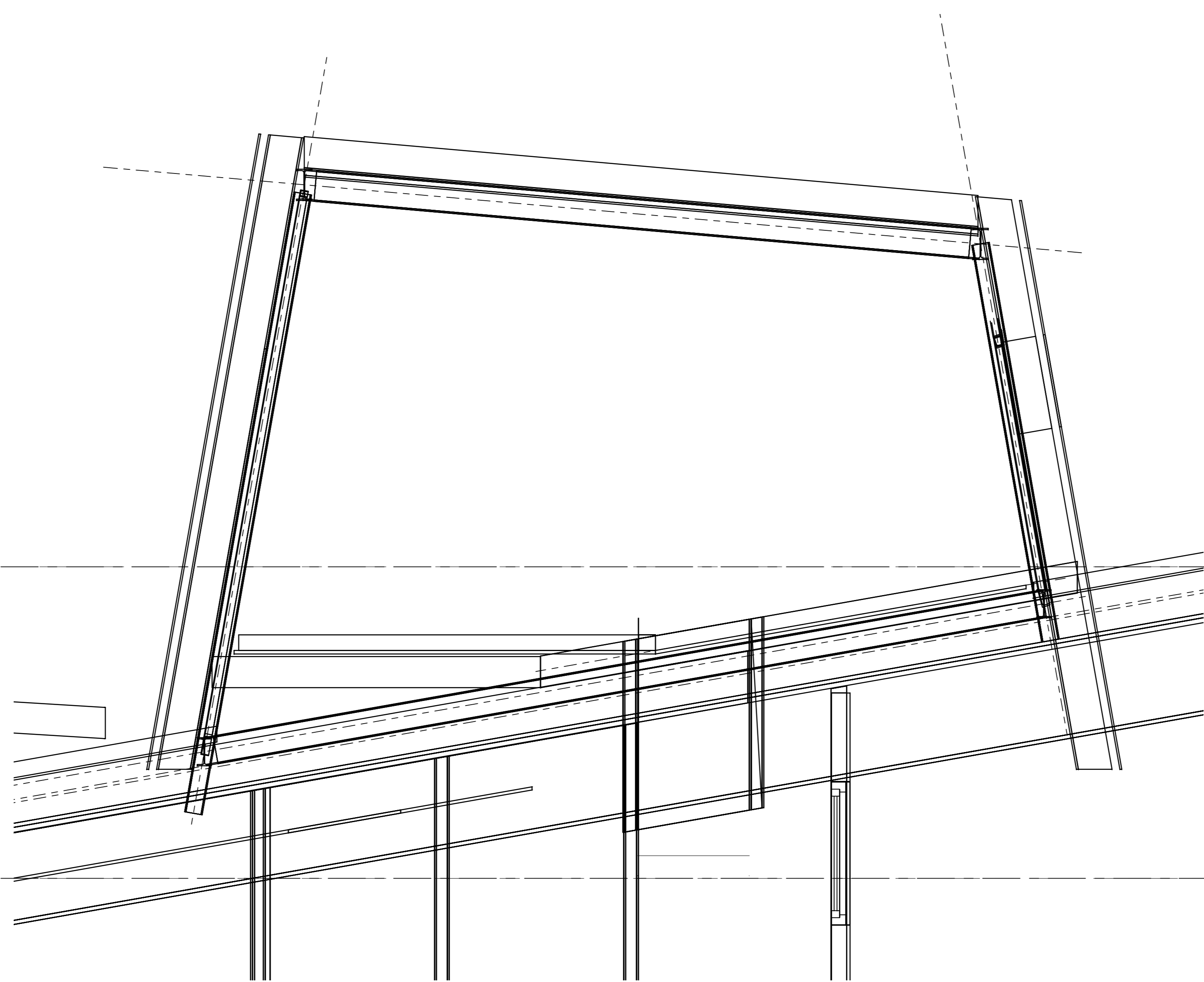

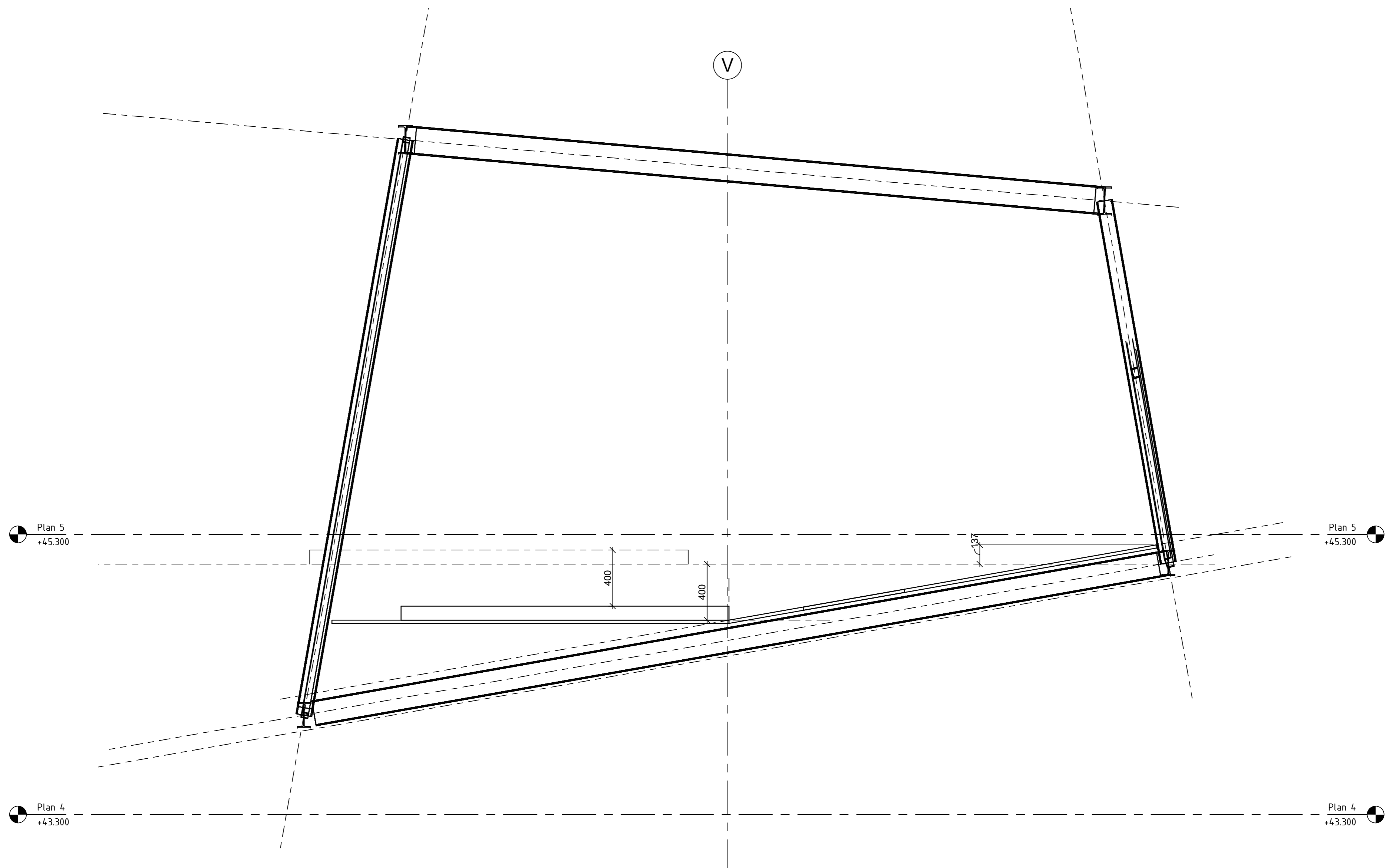

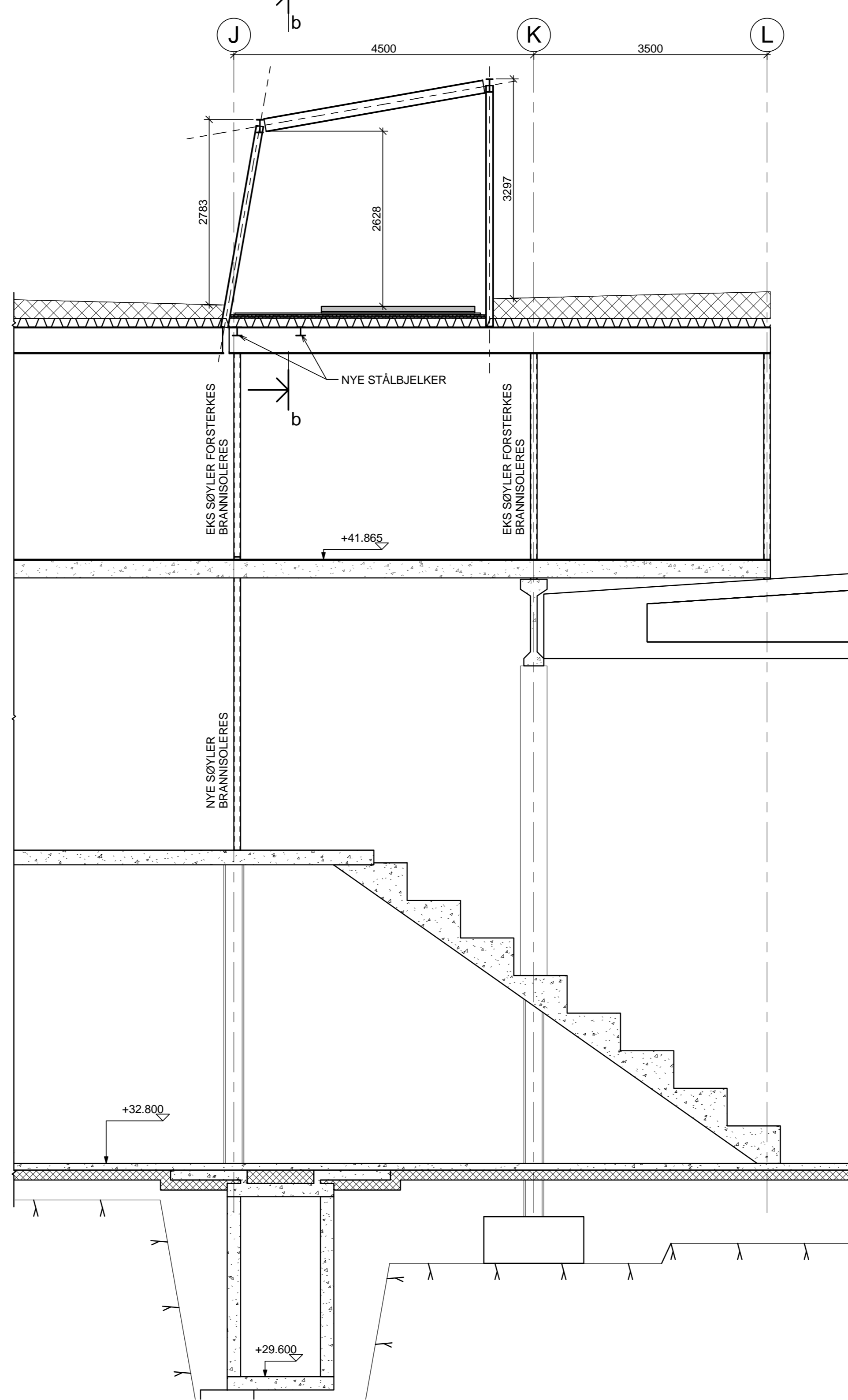

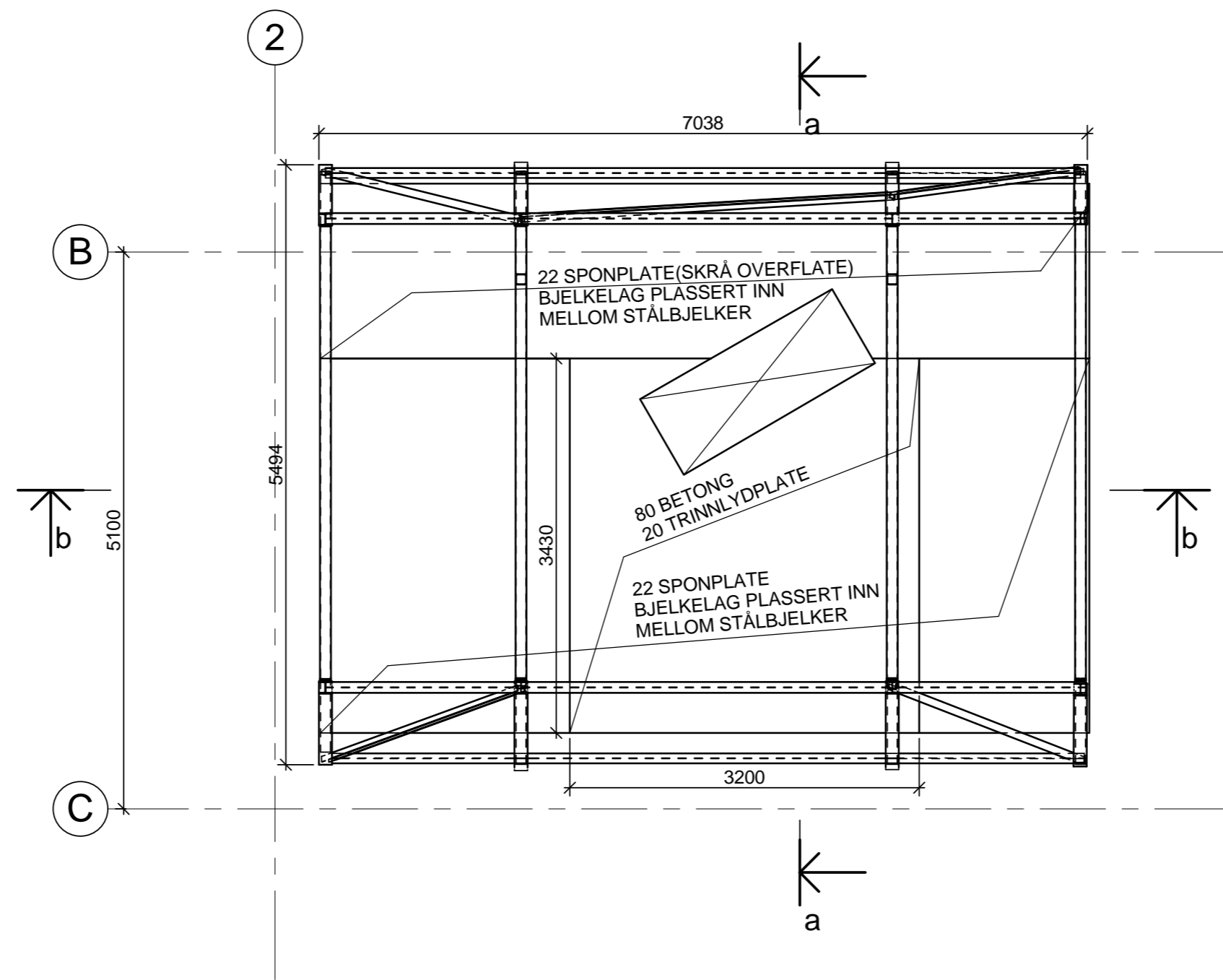

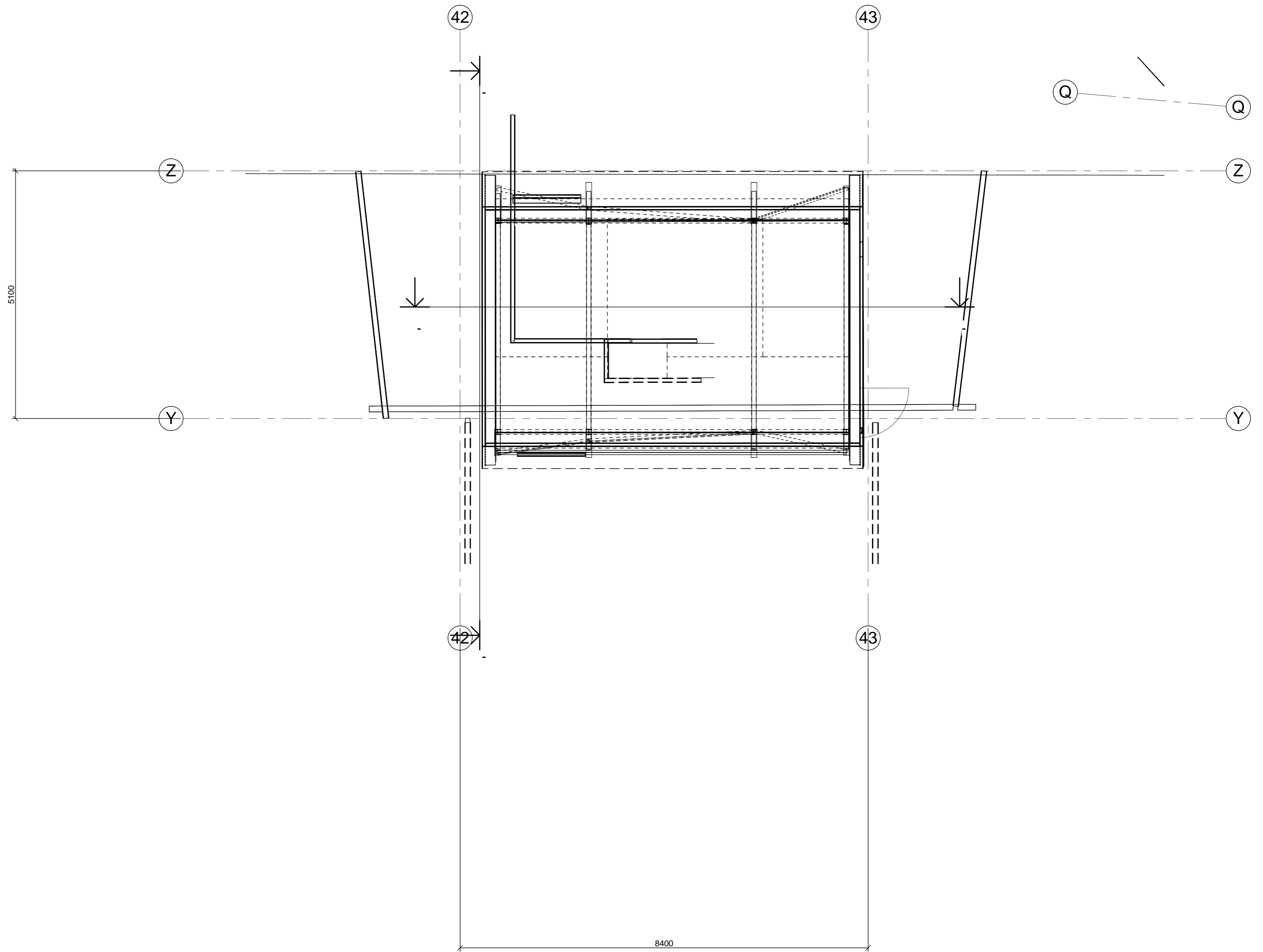

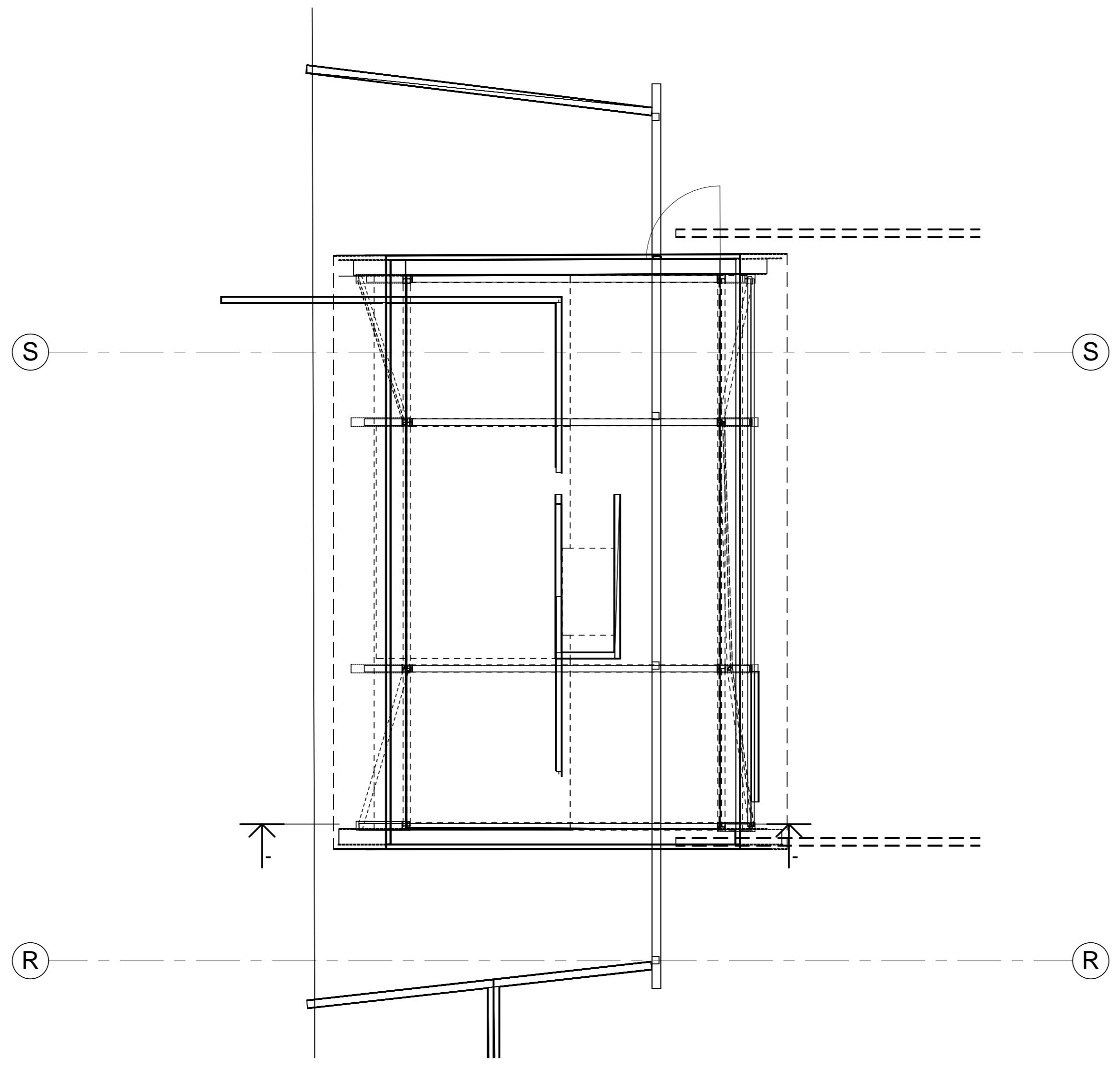

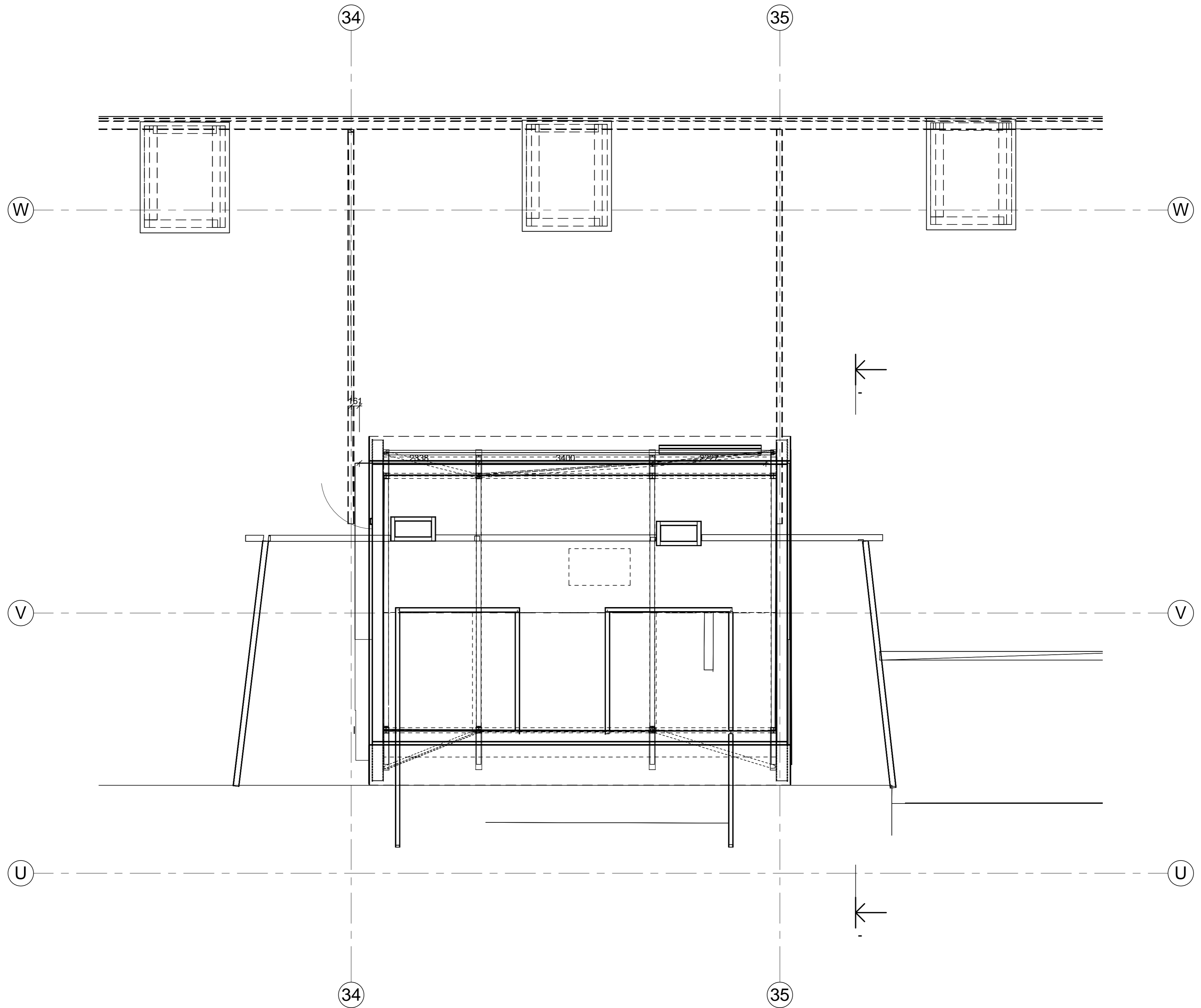

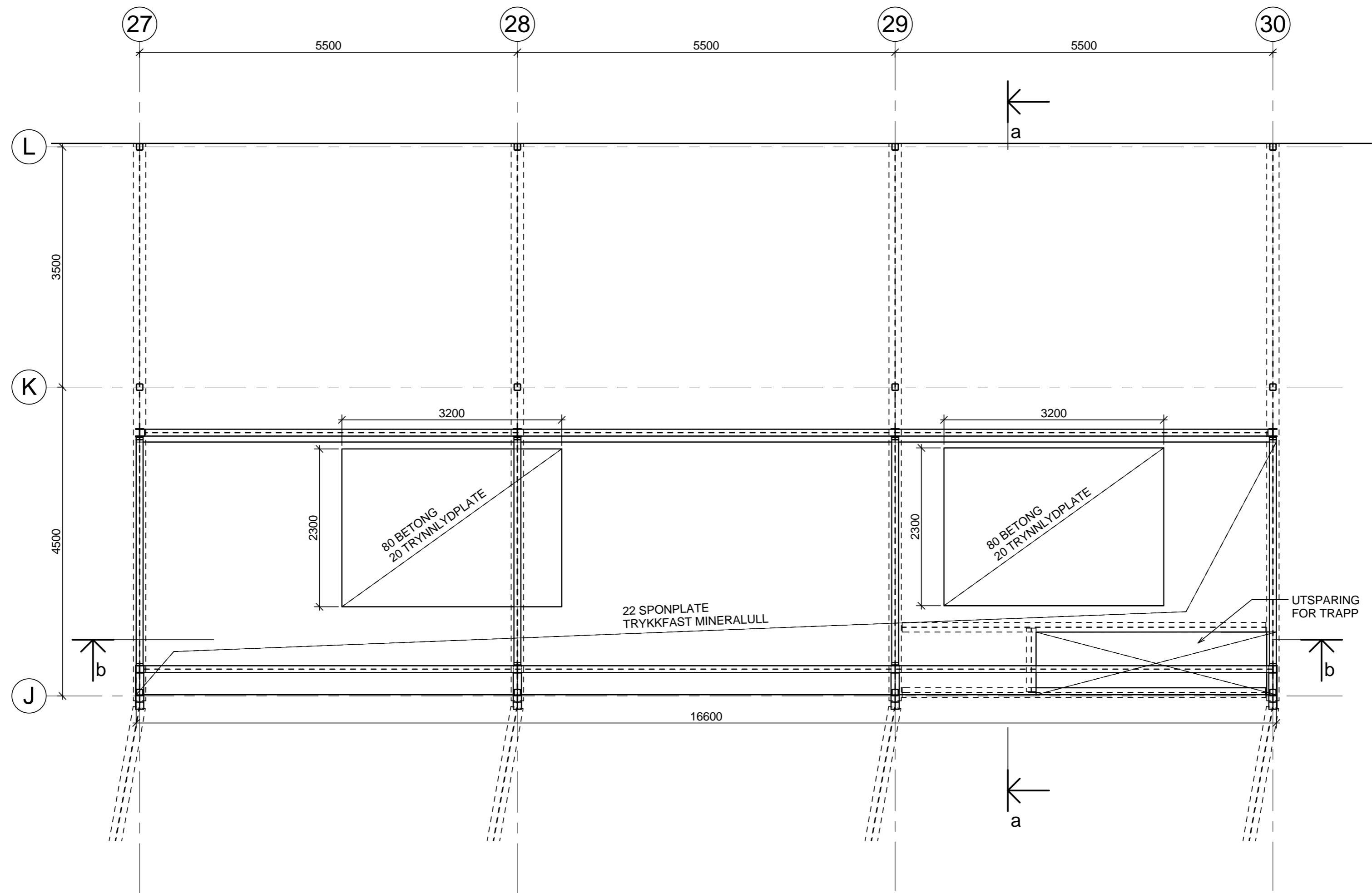

26

