

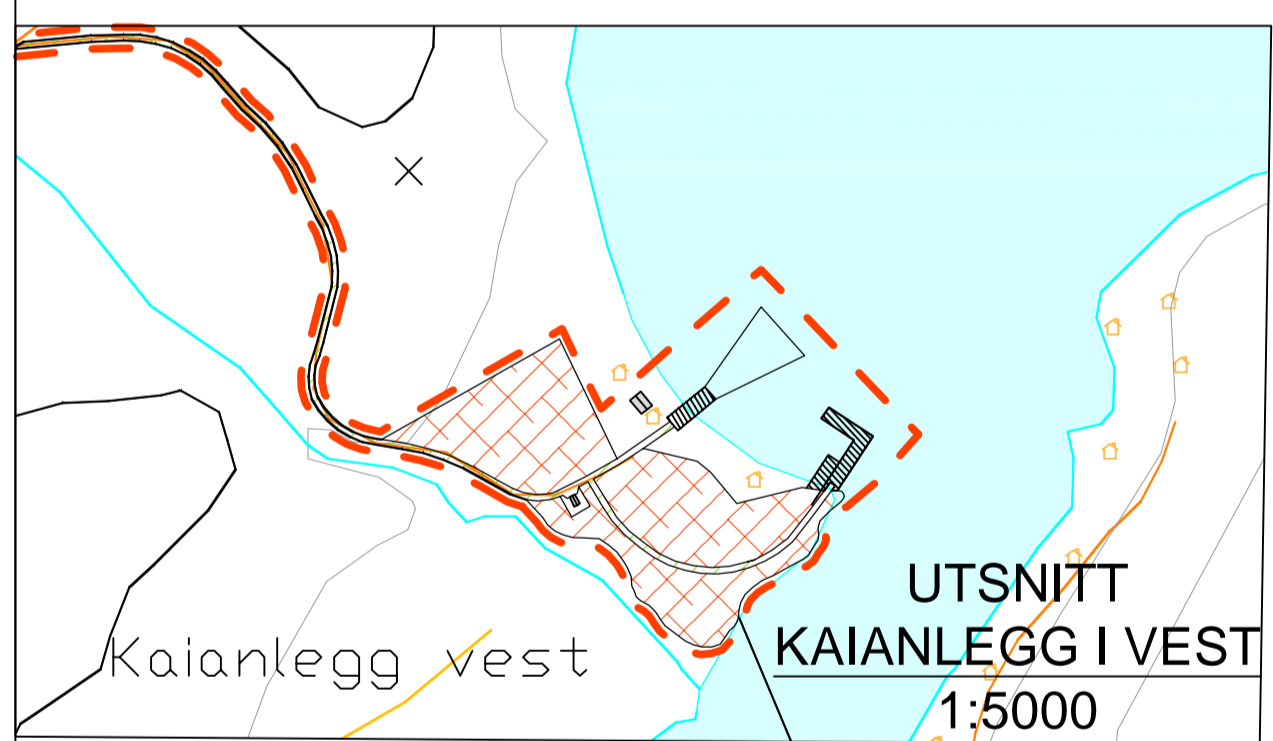

TEGNINGS- OG DISTRIBUTJONSLISTE

TEGNINGER SENDT TIL:

Oppdragsgiver:	Helgeland Kraft AS	Dato:		Liste nr.:																		
		08.07.2016		1																		
Oppdragsnavn:	Vassenden kraftverk	Tegningsformat	Opprinnelig dato	Revisjon	Revisjonsdato	Rørteverandører															Antall kopier pr. format	
Oppdragsnr:	11091002																					
Tegning nr.	Tegningstittel	Antall dokumenter til hver mottaker:			A1	4															4	
					A3																	
					A4																	
	Oversikt																					
11091002-L-10P001	Oversikt, arealbruksplan	A1	07.10.2015			1															1	
	Adkomst- og avløpstunnel																					
11091002-B-60F001	Plan og lengdeprofil	A1	07.10.2015			1															1	
	Kaianlegg																					
11091002-L-82P003	Kaianlegg Vest, arealbruksplan	A1	07.10.2015			1															1	
	Tilløpstunnel																					
11091002-B-90F001	Detaljer	A1	07.10.2015			1															1	
Tegnings- og distribusjonsliste:																						
Forsendelse (P=Post, B=Bud, E=e-post)																						

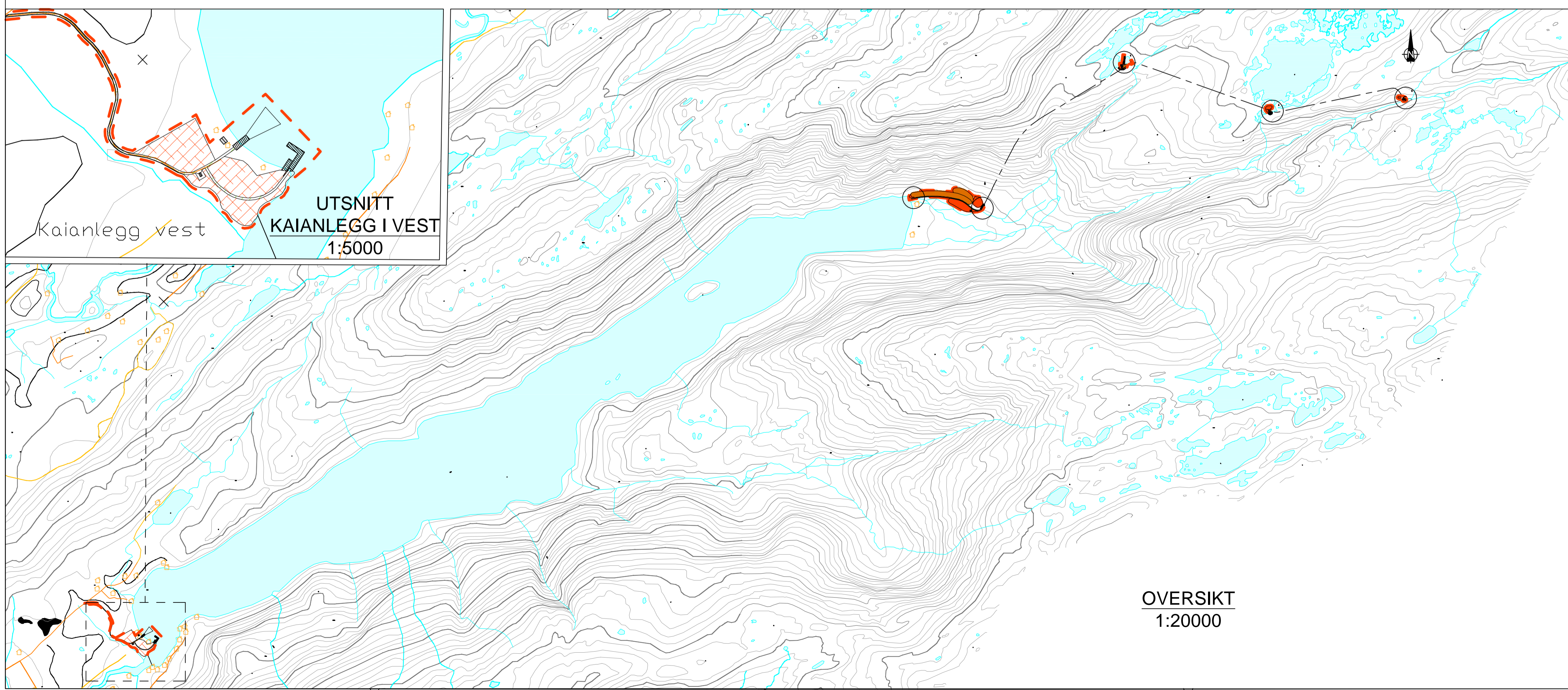
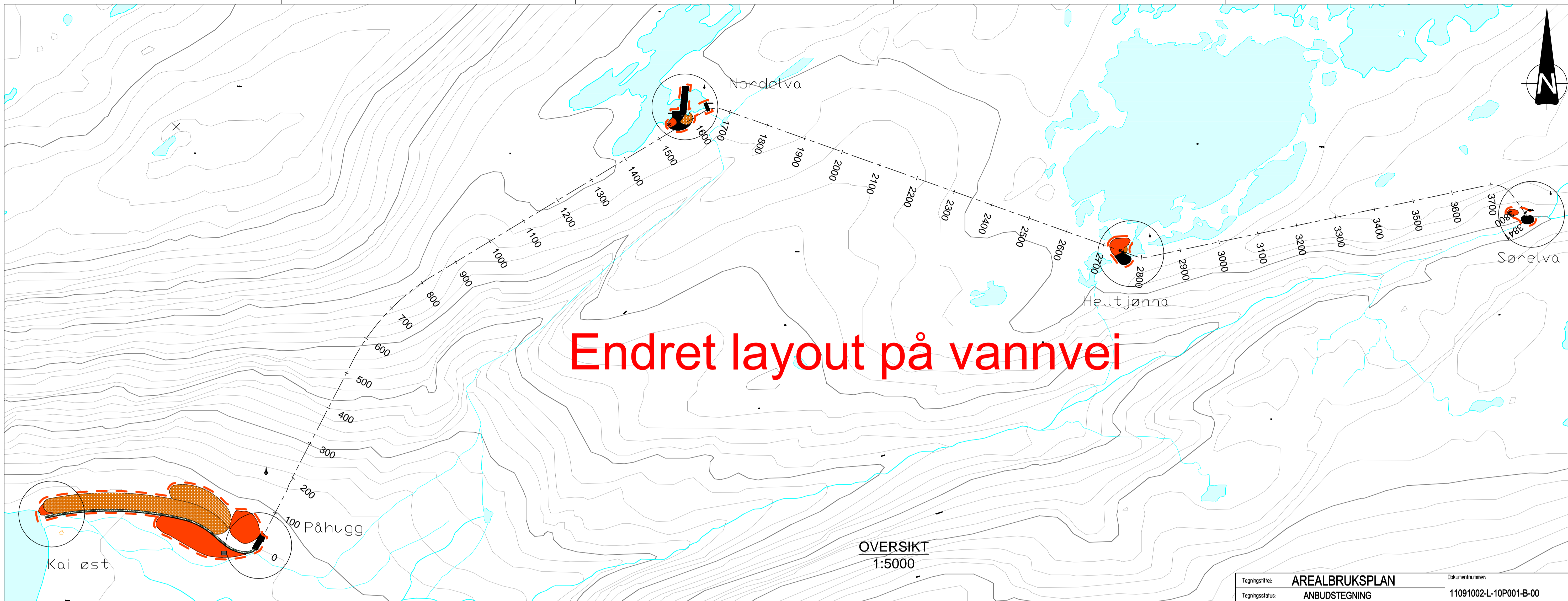

Tegningstittel:	AREALBRUKSPLAN	Dokumentnummer:	11091002-L-10P001-B-00
Tegningsstatus:	ANBUDSTEGNING		

Status	Rev.	Endring	Utført	Kontr.	Ansv.	Dato
HELGELAND KRAFT AS VASSENDEN KRAFTVERK OVERSIKT AREALBRUKSPLAN			NOMAST	NOARHO	NOARHO	07.10.2015
			Målestokk	1:5000		Format A1
			Oppdragsleder:	Anild Høydal		
			Oppdragsnr.	11091002		
SWECO Norge AS <small>SWECO Norge AS PROFESSOR BROCHS GATE 2, 7000 TRONDHEIM TLF.: 73 83 89 00</small>			Disiplin:	L	Lapenummer:	10P001
			Status:	B	Rev.:	00

Alignment - Vannvei alt.

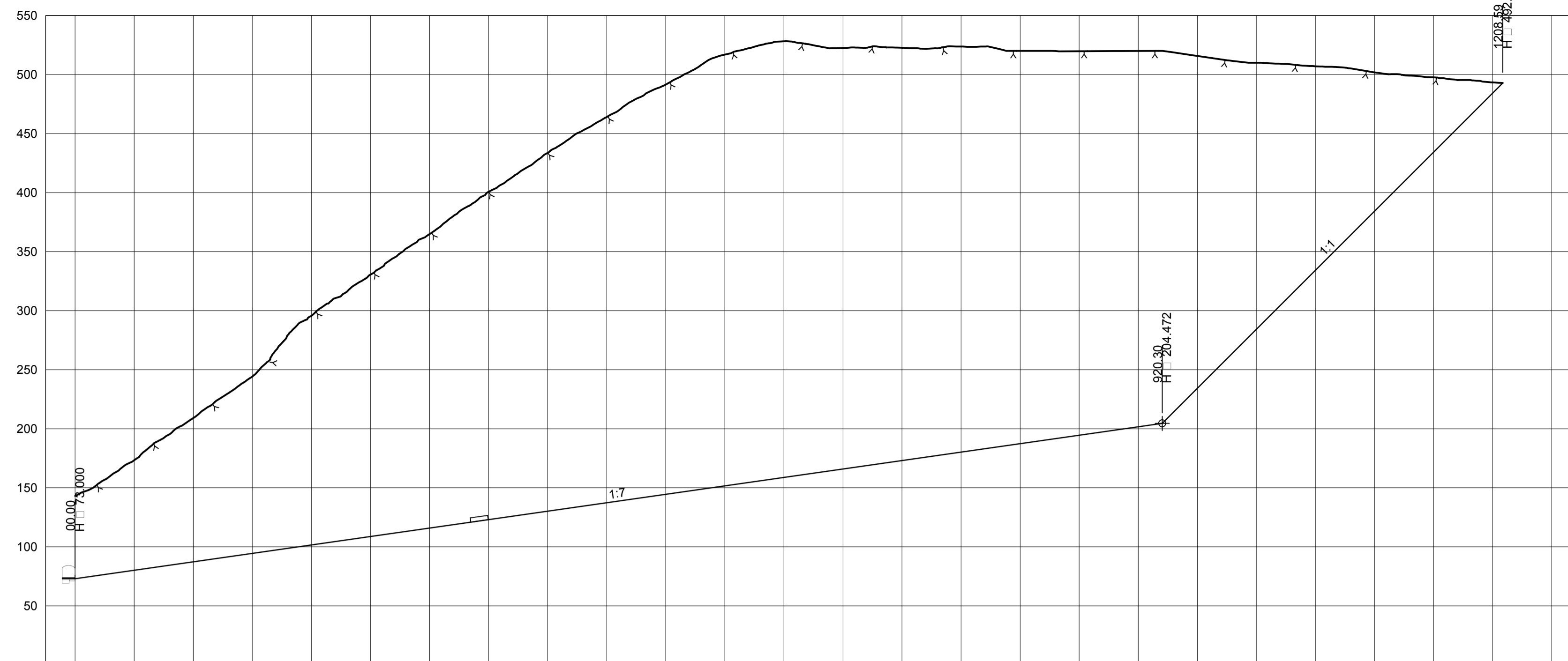

PROFIL NR.	0	50	100	150	200	250	300	350	400	450	500	550	600	650	700	750	800	850	900	950	1000	1050	1100	1150	1200	1250	1275	
HOR.KURV.	L 443.79										R 300.00					L 454.10					L 288.29							
PROFIL H.	73.00	80.14	87.29	94.43	101.57	108.71	115.86	123.00	130.14	137.29	144.43	151.57	158.71	165.86	173.00	180.14	187.29	194.43	201.57	204.472	204.17	204.17	204.17	204.17	204.17	204.17	204.17	204.17
TERRENG H.	143.01	173.25	209.05	244.15	295.65	330.53	364.81	400.65	433.55	463.96	491.43	516.79	528.09	522.49	522.59	523.63	520.00	519.69	519.93	515.69	510.00	506.95	501.79	497.55	493.26	484.17	484.17	484.17

Alignment - Transporttunnel alt.

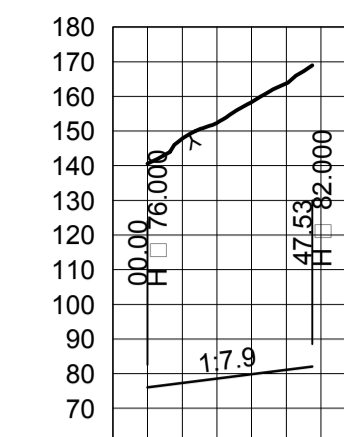

PROFIL NR.	0	10	20	30	40	50	60
HOR.KURV.	L 15.72 21.66						
PROFIL H.	76.00	77.26	78.52	79.79	81.05		
TERRENG H.	140.60	147.83	152.40	158.38	163.75		

1:2000

Alignment - Avløpstunnel alt.

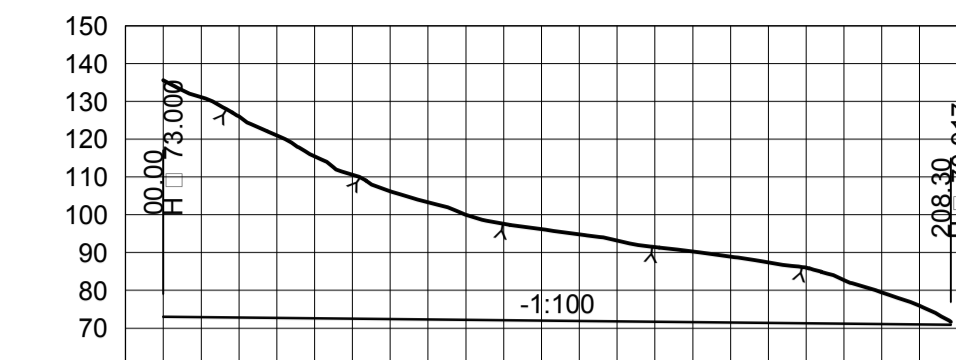

PROFIL NR.	0	10	20	30	40	50	60	70	80	90	100	110	120	130	140	150
HOR.KURV.	L 166.00										R 15.00					
PROFIL H.	73.00	72.80	72.60	72.40	72.20	72.00	71.80	71.60	71.40	71.20	71.00	70.80	70.60	70.40	70.20	70.00
TERRENG H.	135.60	131.06	125.99	120.98	115.43	110.59	106.17	103.30	99.95	96.15	97.61	94.82	91.43	88.25	87.39	86.02

1:2000

Alignment - Adkomsttunnel

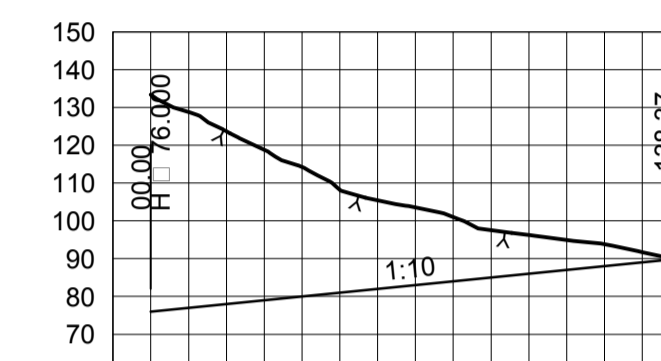

PROFIL NR.	0	10	20	30	40	50
HOR.KURV.						
PROFIL H.	76.00	77.00	78.00	79.00	80.00	81.00
TERRENG H.	133.40	128.77	123.69	118.77	114.24	109.20

1:2000

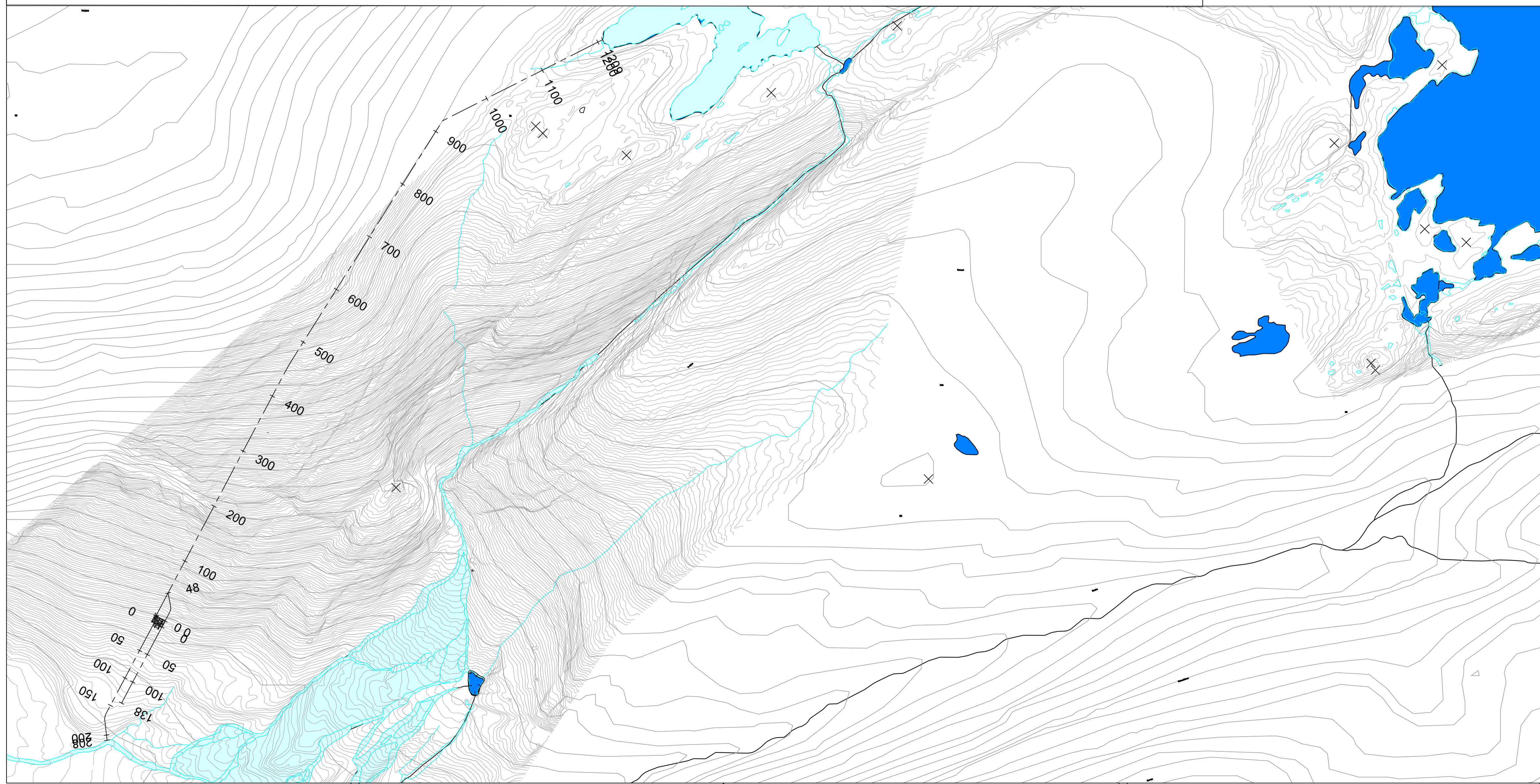

Tegningstittel:	TILLØPS- OG RØRTUNNEL	Dokumentnummer:	11091002-B-60F001-B-00
Tegningsstatus:	ANBUDSTEGNING		

Status/ Rev:	Endring	Utført	Kont.	Ansv.	Dato
HELGELAND KRAFT AS		NOE/PE	NOARHO	NOARHO	25.05.2016
VASSENDEN KRAFTVERK		Målestokk	1:3000	Format	A1
ALTERNATIV VANNVEI		Oppdragsleder:	Arild Høydal		
SKISSE		Oppdragsnr.	11091002		
PLAN OG LENGDEPROFIL		Disiplin:	Løpernummer:	Status:	Rev:
SWECO Norge AS		B	60F001	B	00

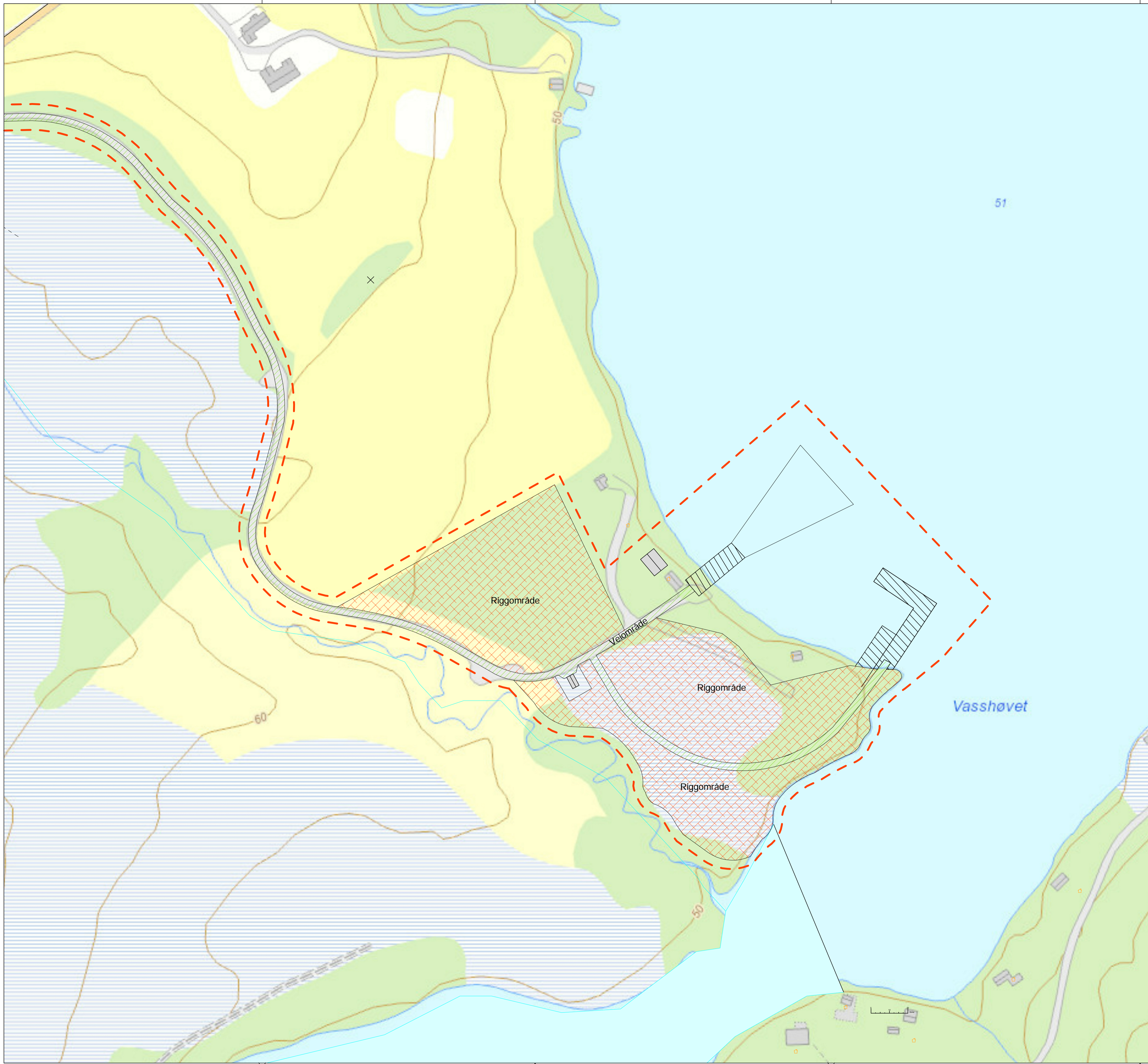

Tegningstittel:	AREALBRUKSPLAN	Dokumentnummer:	11091002-L-80P003
Tegningsstatus:	ANBUDSTEGNING		

Tegnforklaring

Flater	
	Riggområde
	Velområde
Linjer	
	Inngrepsgrense
	Arealavgrensning

Status	Rev.	Endring	Utført	Kontr.	Ansv.	Dato
			NOMAST	NOARHO	NOARHO	07.10.2015
HELGELAND KRAFT			Målestokk	1:1000	Format	A1
VASSENDEN KRAFTVERK			Oppdragsleder:	Anild Høydal		
KAIANLEGG VEST			Oppdragsnr.	11091002		
AREALBRUKSPLAN			Disiplin:	L	Lapenummer:	82P003
SWECO			Status:	B	Rev.:	00

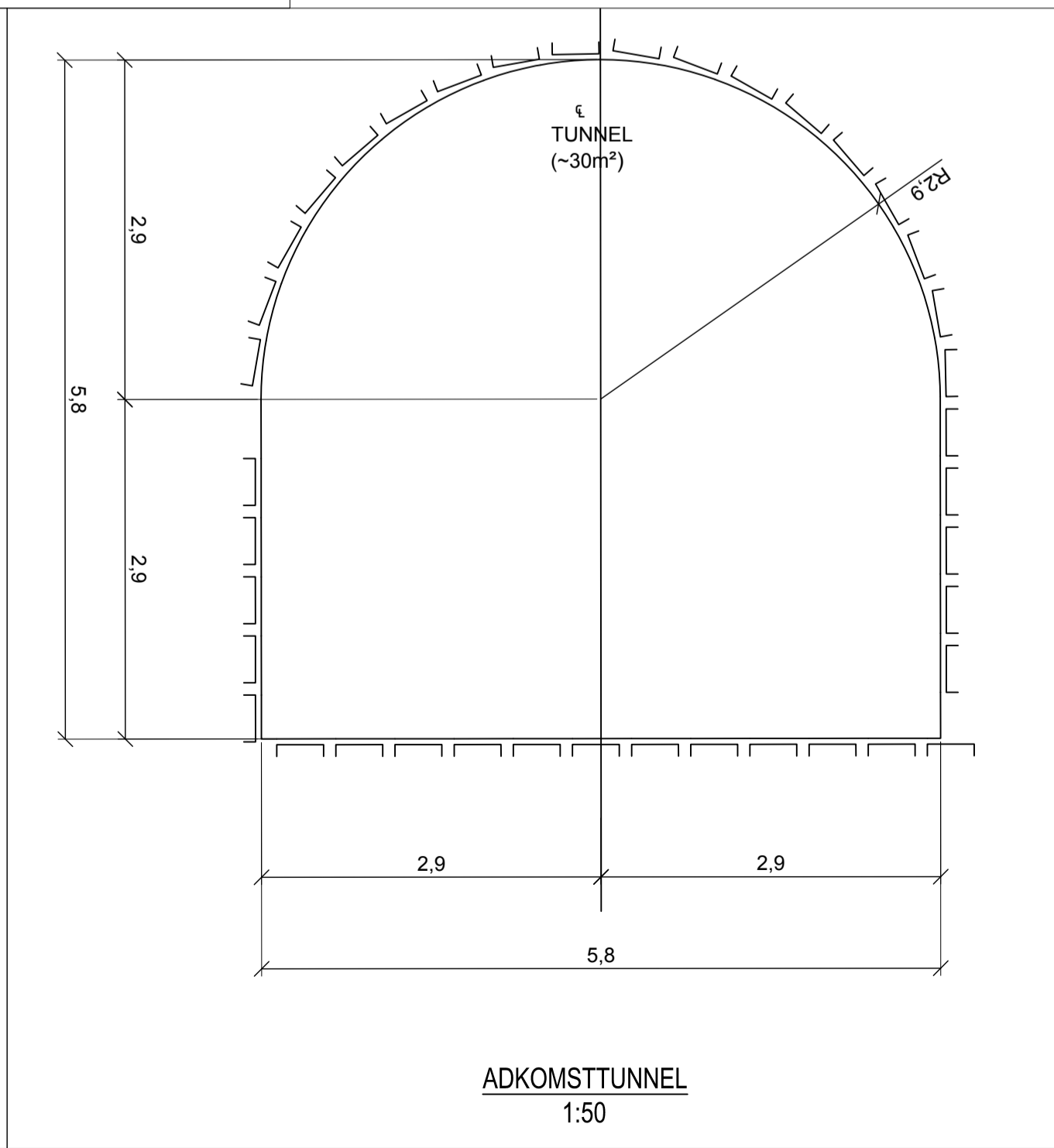
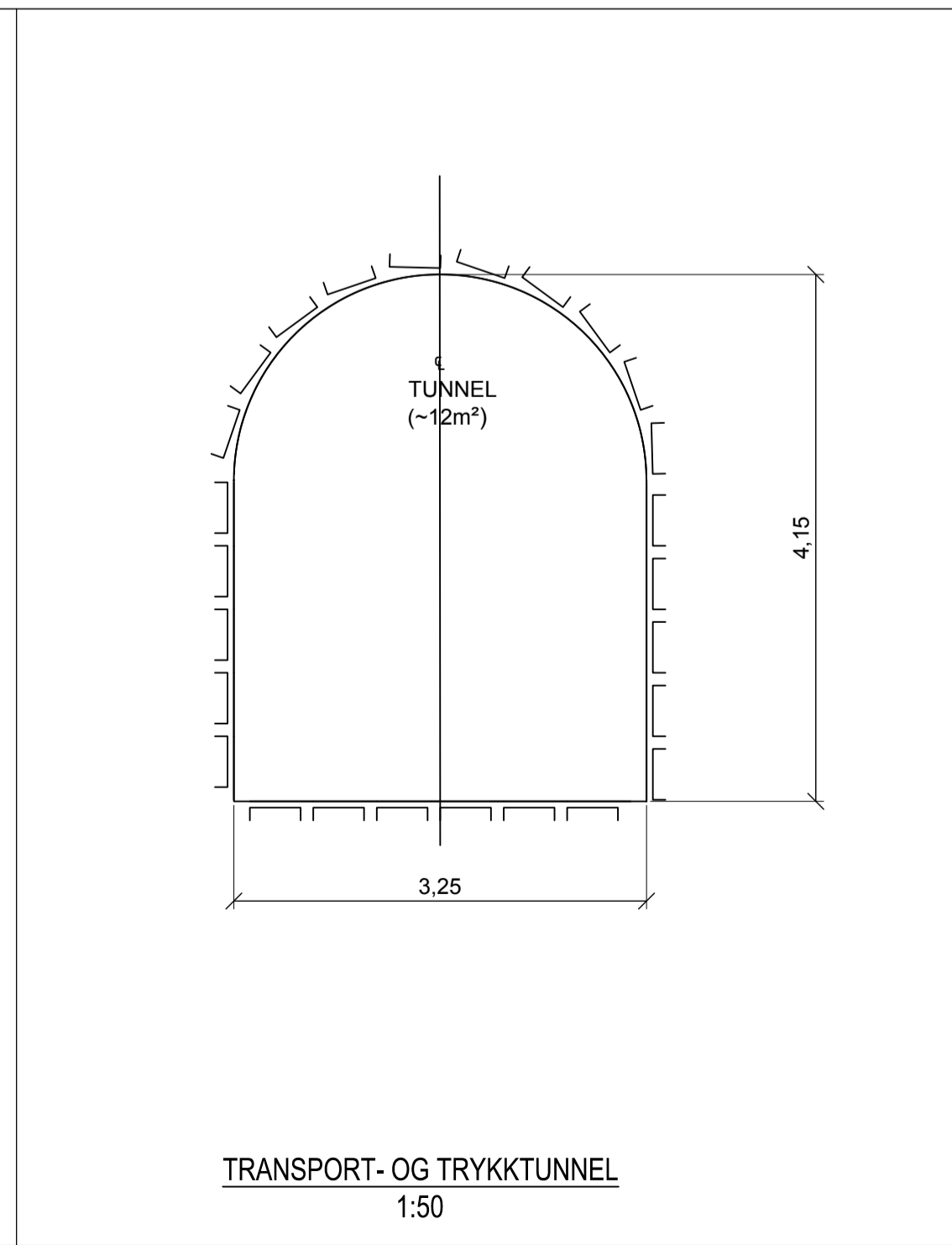
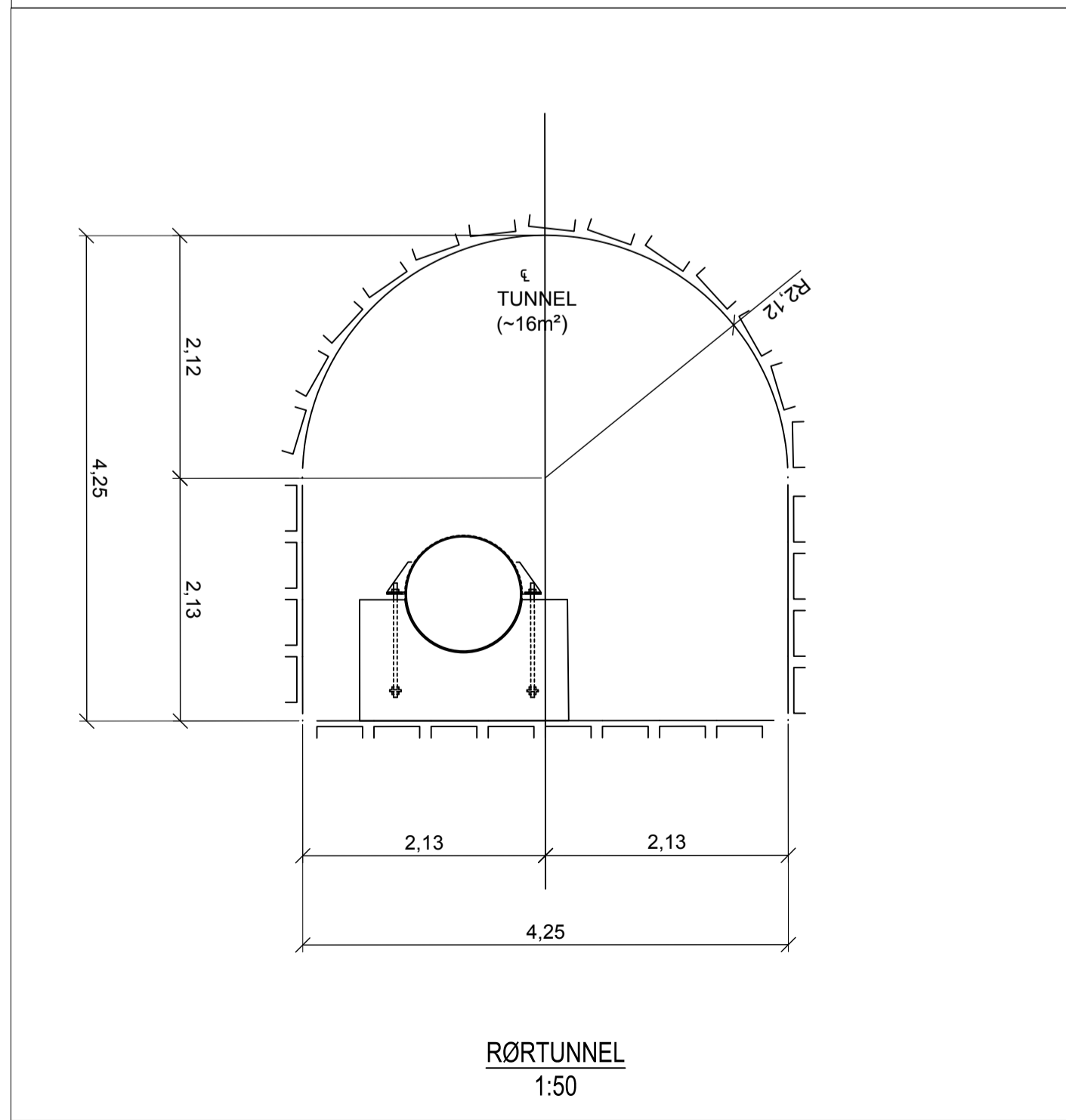
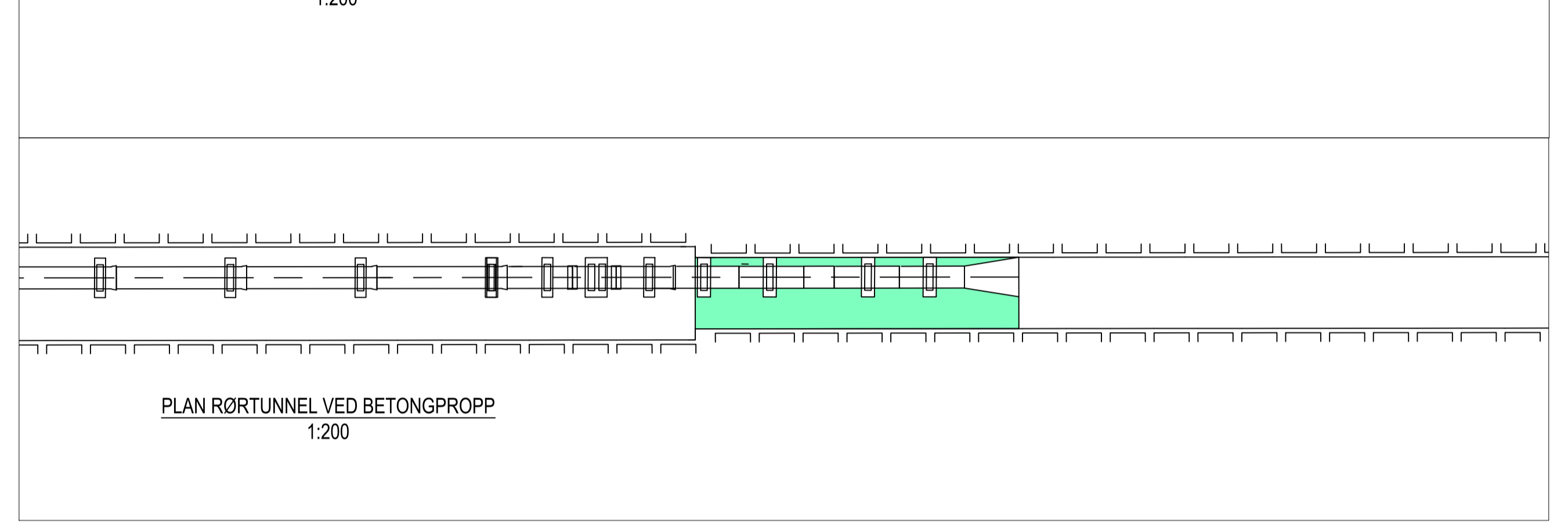
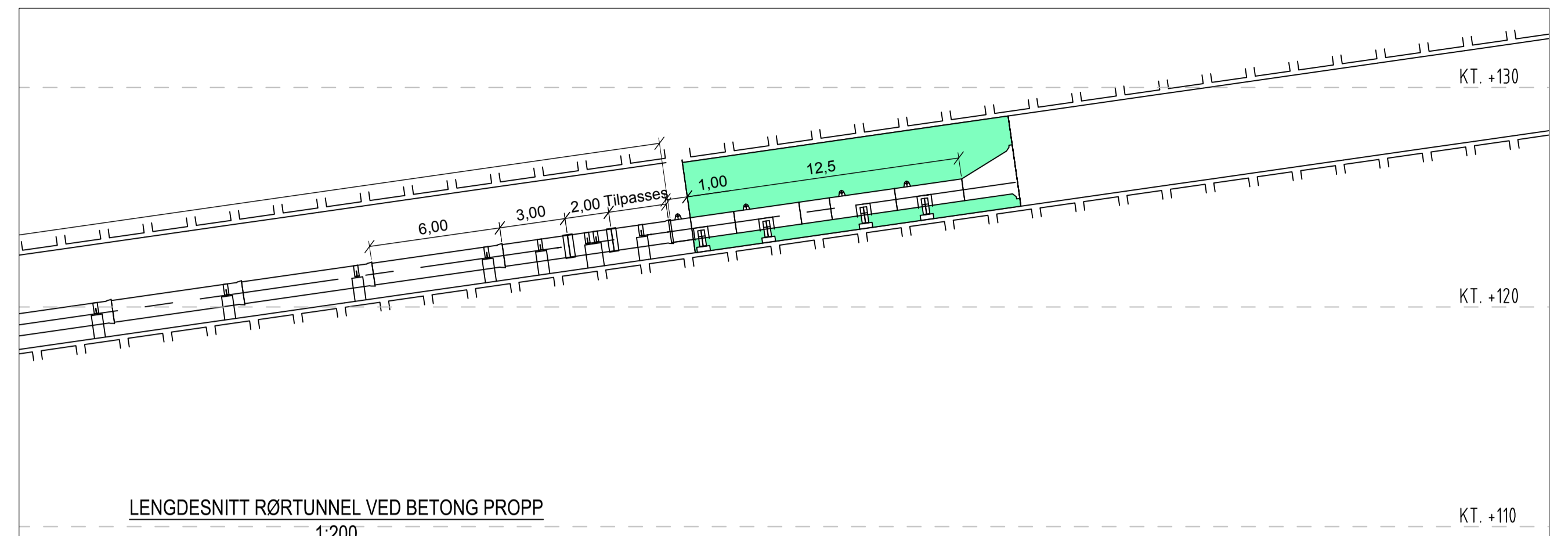
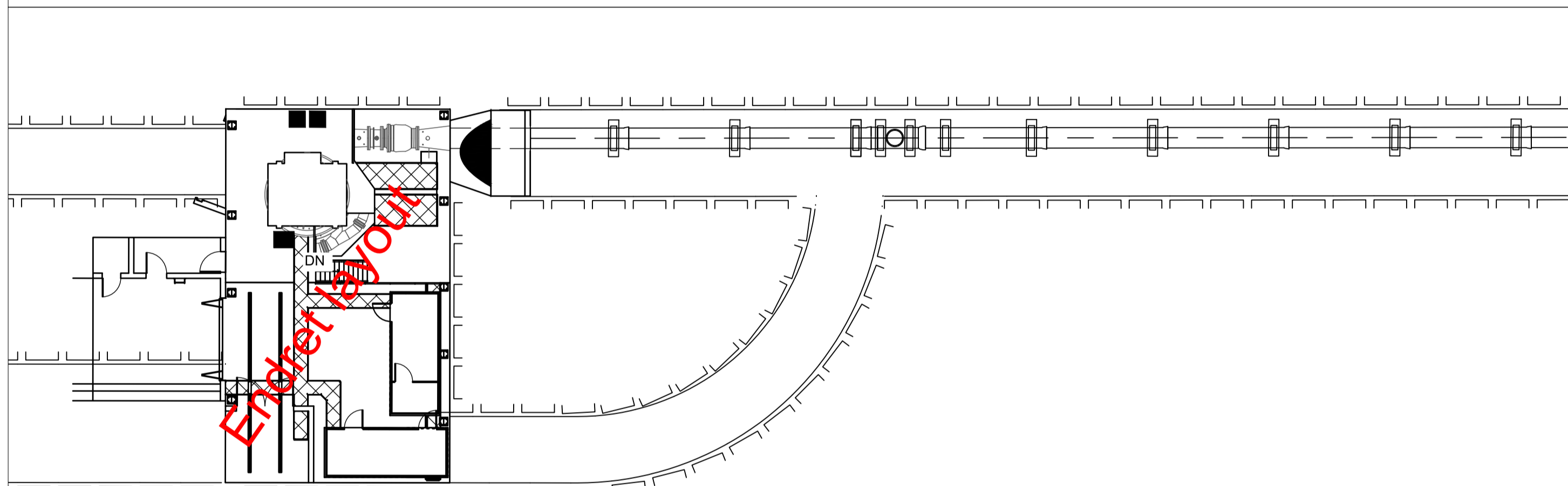
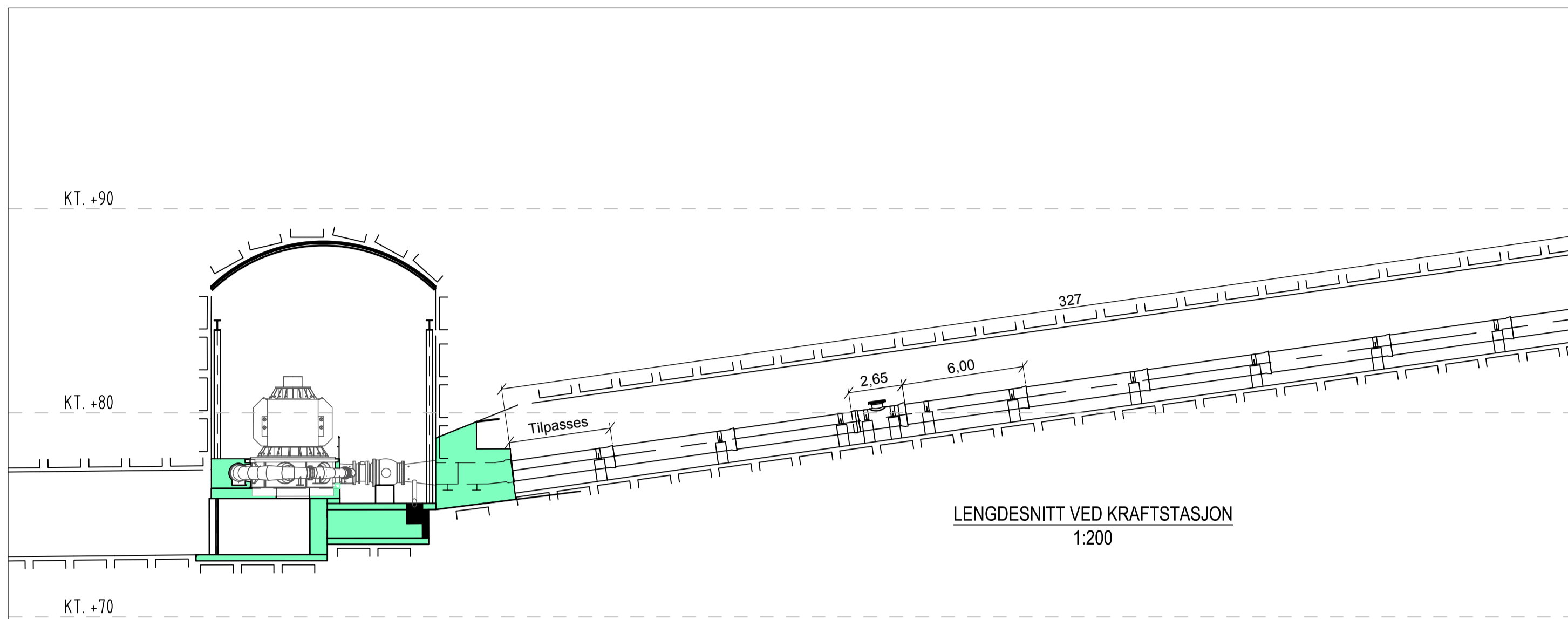

Tegningsittel:	TUNNEL	Dokumentnummer:	11091002-B-90F001-B-01
Tegningsstatus:	ANBUDESTEGNING		

B	01	JUSTERT TUNNEL	EIPE	ARHO	ARHO	29.06.2016
Status/	Rev.	Endring	Utført	Kontrollert	Ansv.	Dato
HELGELAND KRAFT AS			NOMAST	NOARHO	NOARHO	07.10.2015
VASSENDEN KRAFTVERK			Målestokk:	1:200, 1:50	Format:	A1
TILLØPSTUNNEL			Oppdragsleder:	Arild Høydal		
DETALJER			Oppdragsnr.:	11091002		
SWECO Norge AS PROFESSOR BRØCHS GATE 2, 1305 TRONDHEIM TLF.: 73 83 35 00 FAX:			Disiplin:	Løpernummer:	Status:	Rev.:
			B	90F001	B	01