

PLAN U
1:50

TILBUDSTEGNING

Status	Rev	Endring	Utført	Kontr.	Ansv.	Dato
			MIB	TB	SEB	27.01.2014
LIER KOMMUNE VANN OG AVLØP SJÅSTAD RENSEANLEGG (RA160)			Målestokk	1:50 (A1)		Format
PLAN KJELLER VVS ANLEGG			Oppdragsleder:		SVEIN ERIK BAKKEN	
			Oppdragsnr.		147241	
SWECO Norge AS FORNEBUSHVEIEN 11, 1327 LYSAKER TLF: 67 12 80 00 FAX: 67 12 58 40			Disiplin:	Løpnummer:	Status:	Rev:
			V	100	B	

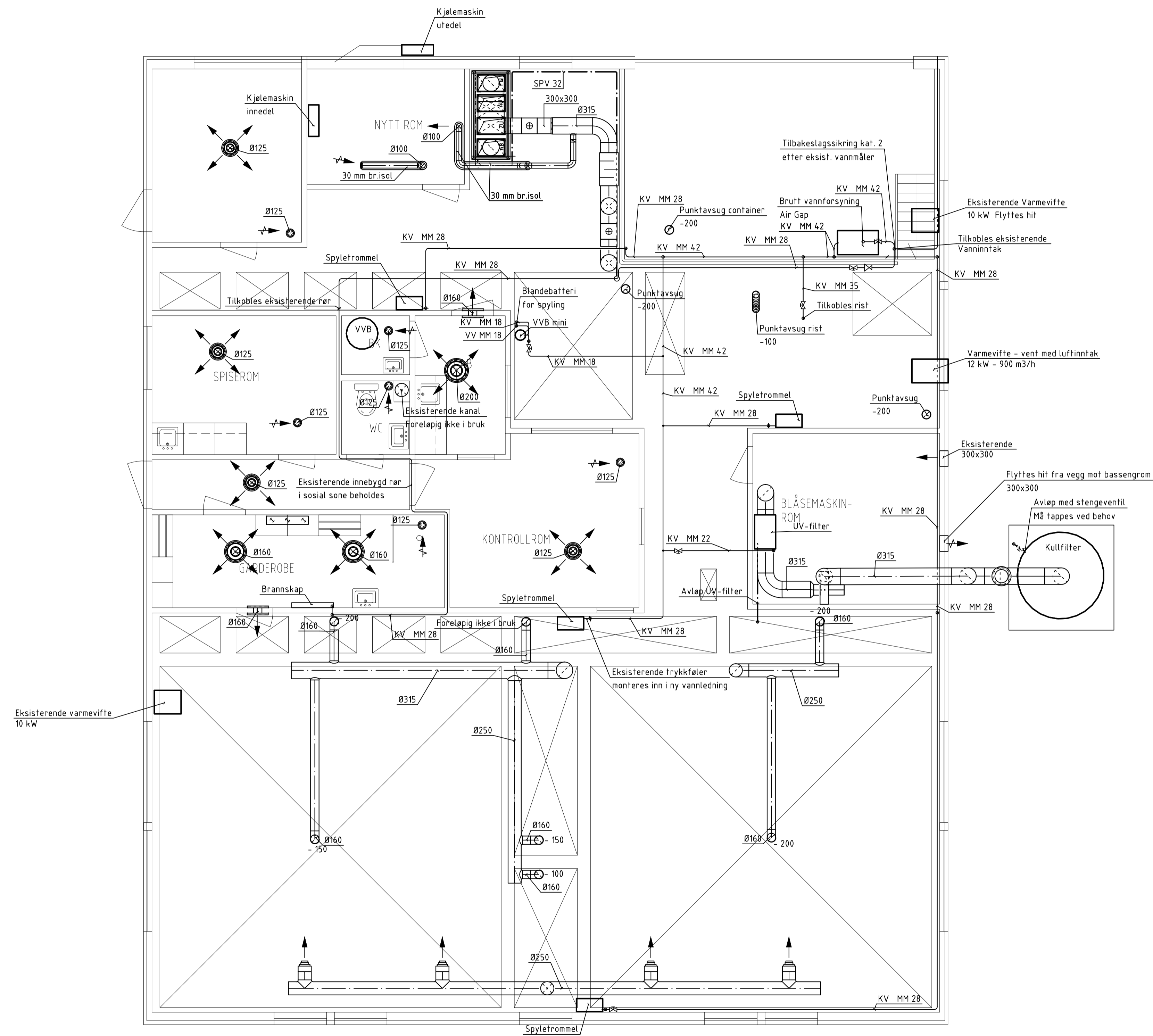

TILBUDSTEGNING

Status	Rev	Endring	Utført	Kontr.	Ansv.	Dato
			MIB	TB	SEB	27.01.2014
LIER KOMMUNE VANN OG AVLØP SJÅSTAD RENSEANLEGG (RA160)			Målestokk	1:50 (A1)	1:100 (A3)	Format A1
PLAN 1. ETASJE VVS ANLEGG			Oppdragsleder:	SVEIN ERIK BAKKEN		
			Oppdragsnr.	147241		
			Disiplin:	V	Løpenummer:	110
<small>SWECO Norge AS FORNERSBUEGGEN 11, 1327 LYSAKER TLF.: 67 12 80 00 FAX.: 67 12 58 40</small>			Status:	B	Rev:	

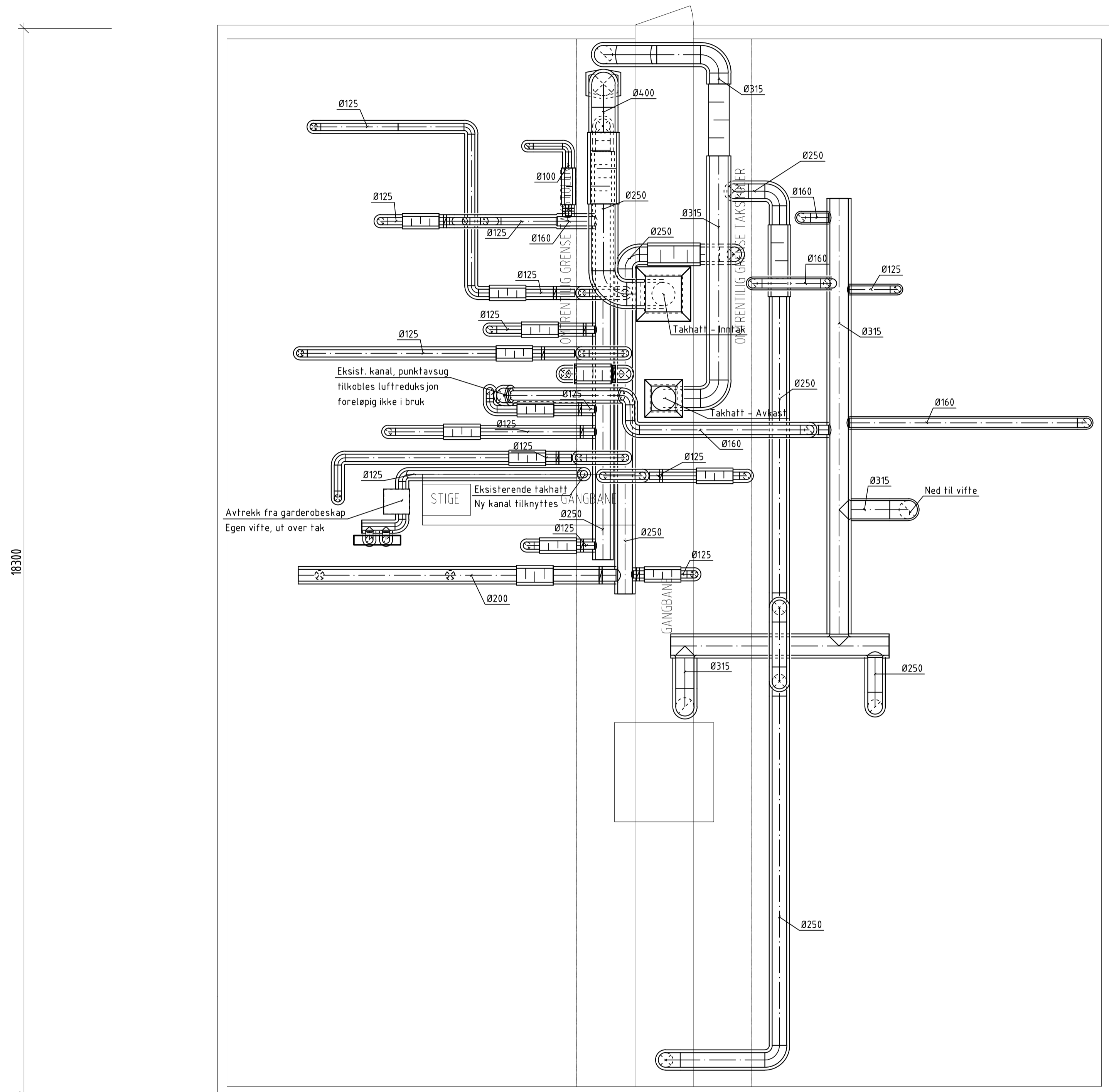

TILBUDSTEGNING

Status	Rev	Endring	Utført	Kontr.	Ansv.	Dato
			MIB	TB	SEB	27.01.2014
LIER KOMMUNE VANN OG AVLØP SJÅSTAD RENSEANLEGG (RA160)			Målestokk	1:50 (A1)		Format A1
				1:100 (A3)		
PLAN LOFT VVS ANLEGG			Oppdragsleder:	SVEIN ERIK BAKKEN		
			Oppdragsnr.	147241		
			Disiplin:	Løpnummer:	Status:	Rev:
<small>SWECO Norge AS FORNEBUSHAGEN 11, 1327 LYSAKER TLF.: 67 12 80 00 FAX.: 67 12 58 40</small>			V	120	B	

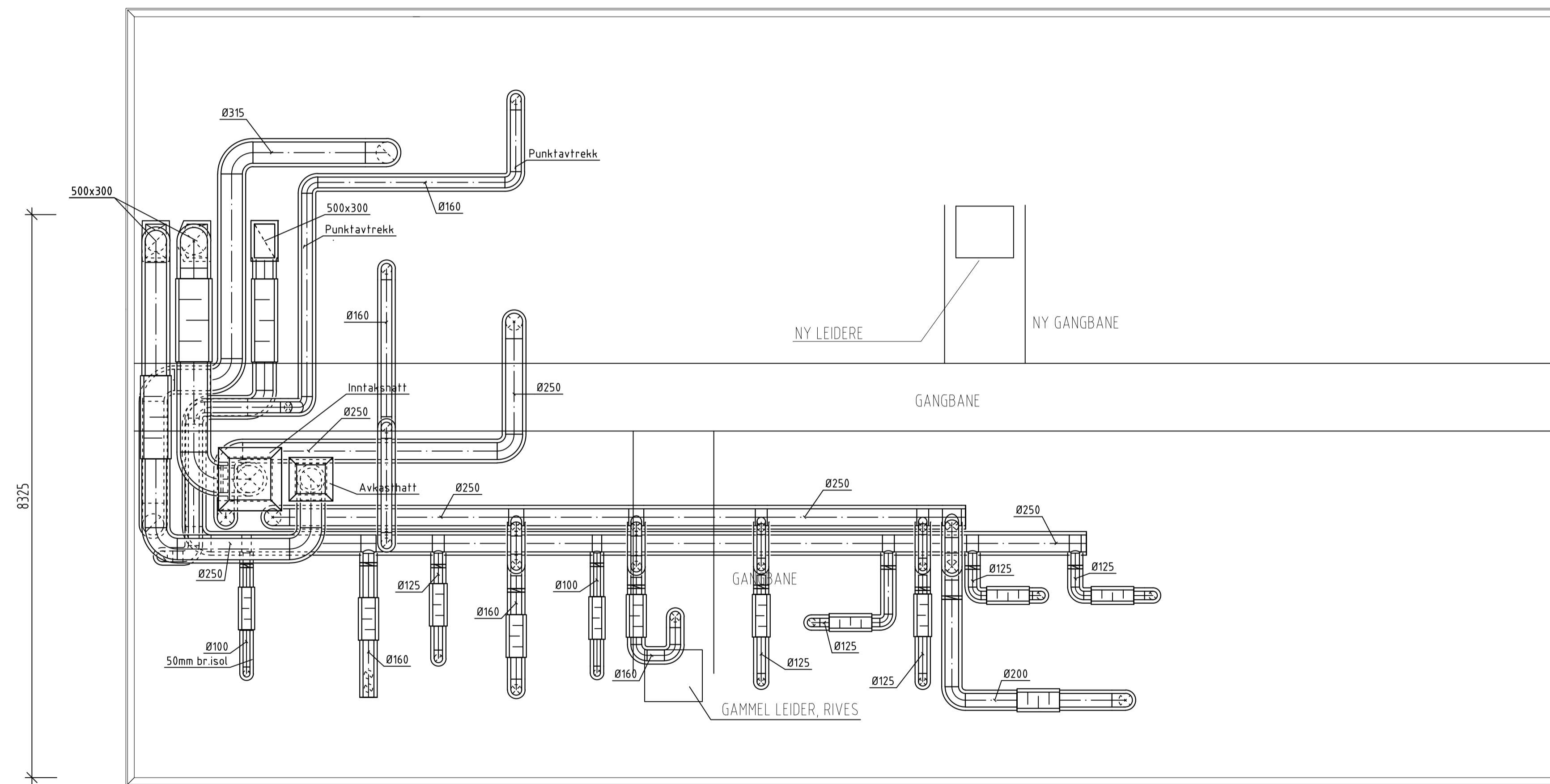

TILBUDSTEGNING

Status	Rev	Endring	Utført	Kontr.	Ansv.	Dato
			MIB	TB	SEB	27.01.2014
LIER KOMMUNE VANN OG AVLØP SYLLING RENSEANLEGG (RA170)			Målestokk	Format		
PLAN LOFT VVS ANLEGG			1:50 (A1)	1:100 (A3)		A1
			Oppdragsleder: SVEIN ERIK BAKKEN			
			Oppdragsnr. 147241			
SWECO  SWECO Norge AS FORNEBUSHAGEN 11, 1327 LYSAKER TLF: 67 12 80 00 FAX: 67 12 58 40			Disiplin:	Løpnummer:	Status:	Rev:
			V	120	B	

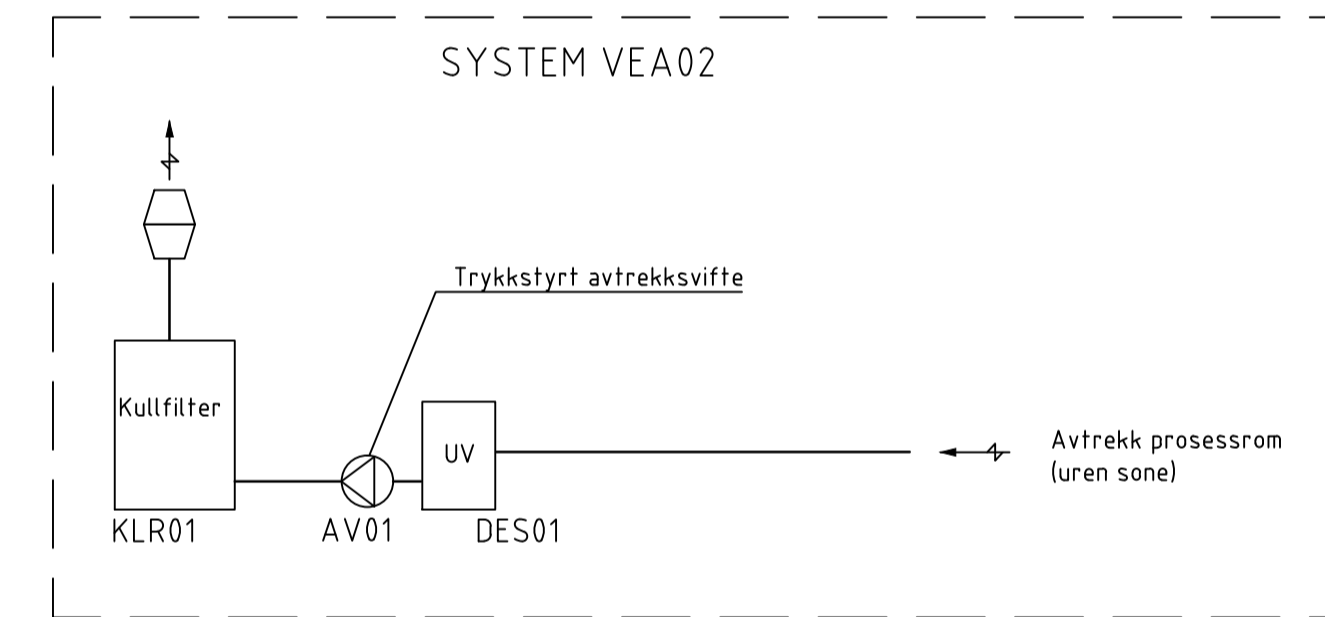
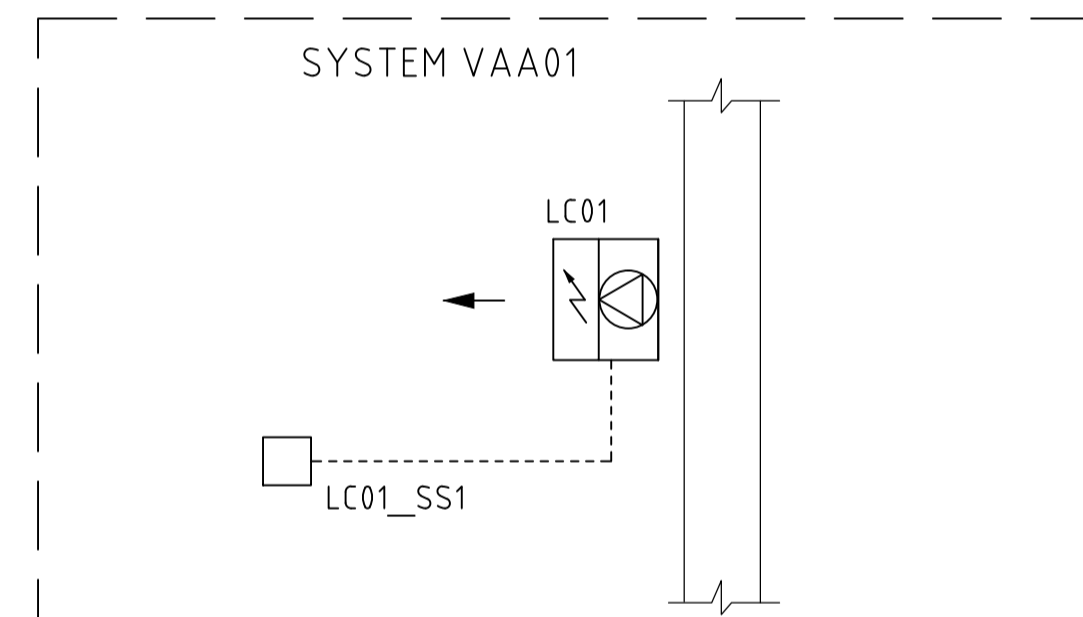
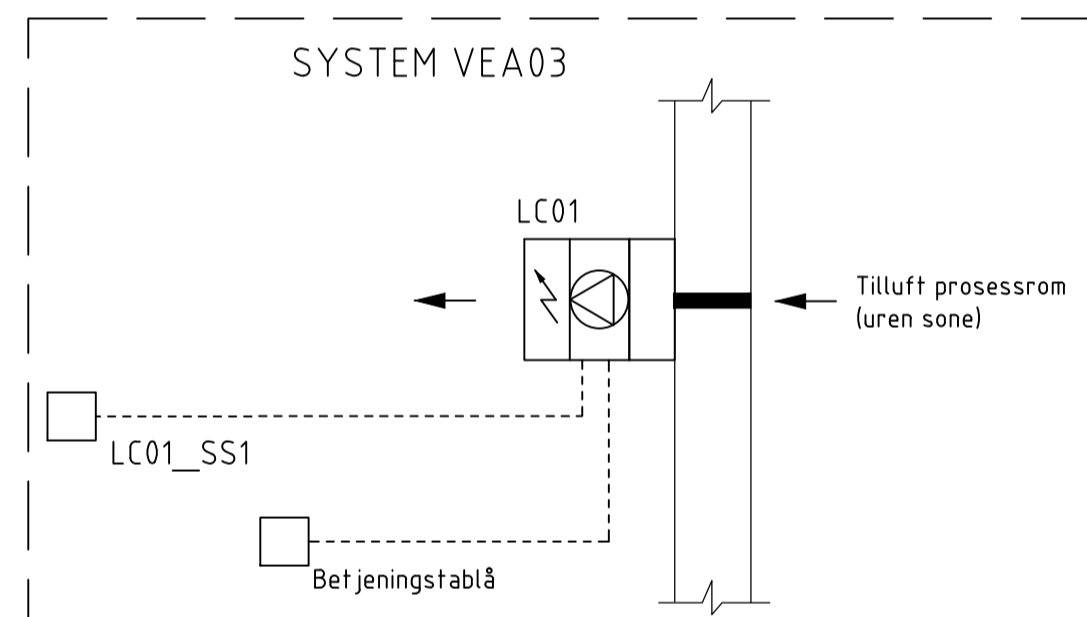
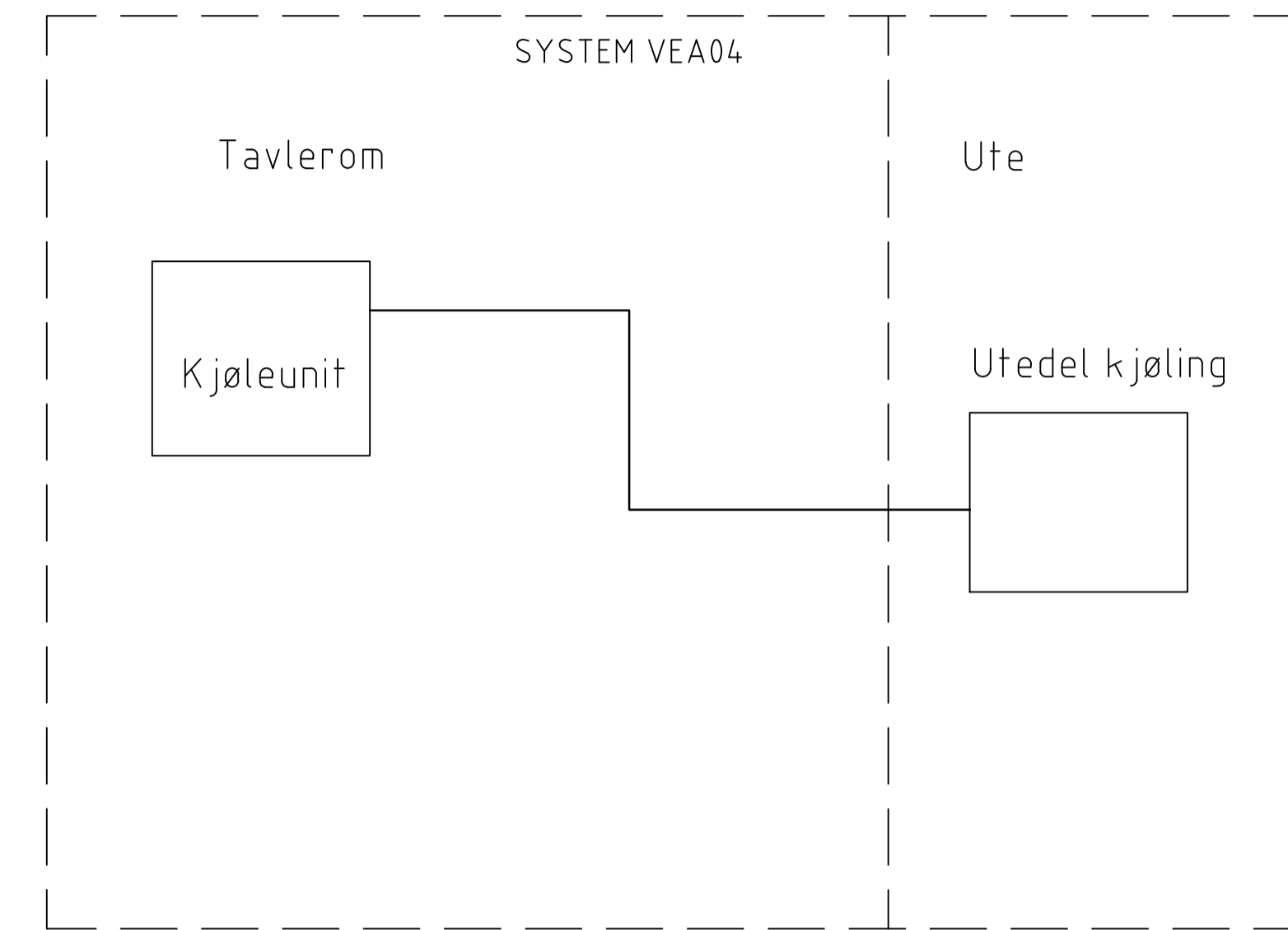
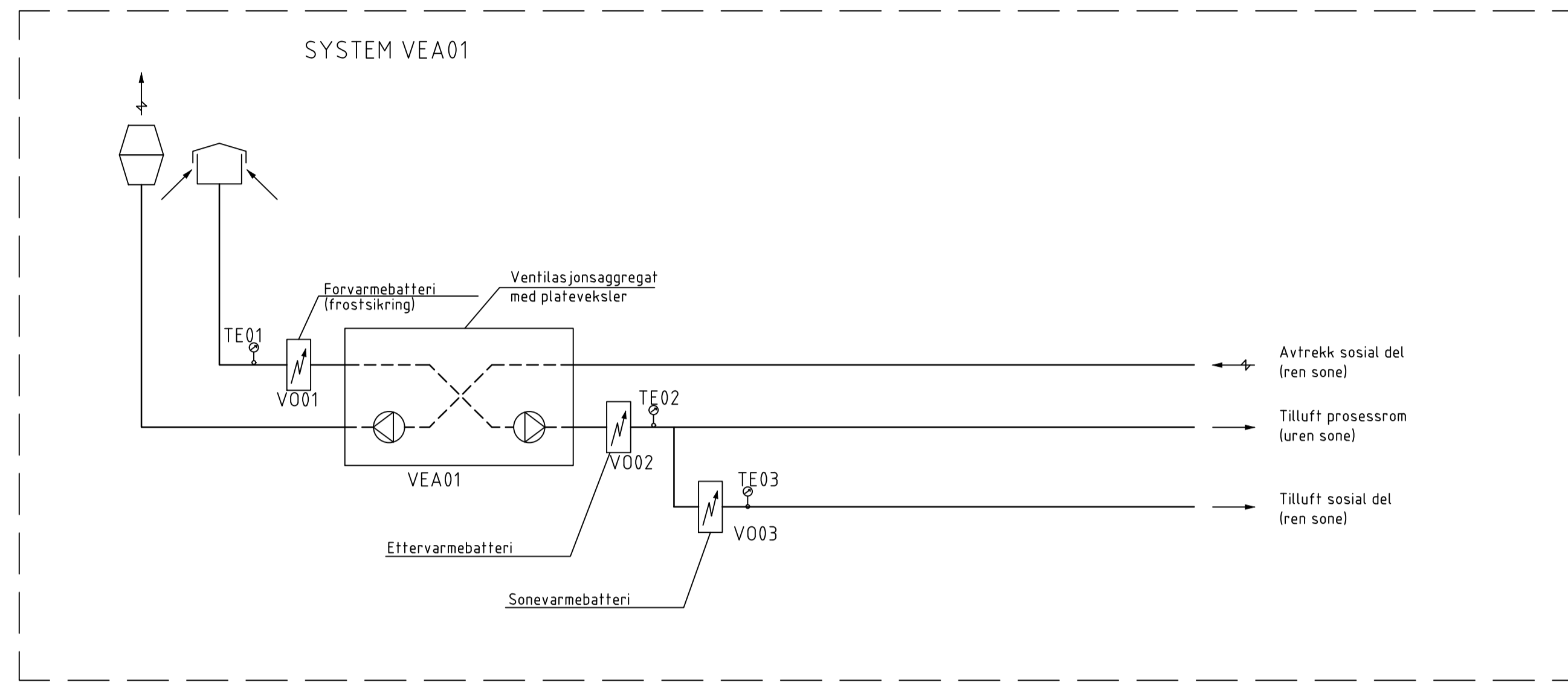

TILBUDSTEGNING

Status	Rev.	Endring	Utført	Kontr.	Ansv.	Dato
			MIB	TB	SEB	27.01.2014
LIER KOMMUNE VANN OG AVLØP SYLLING RENSEANLEGG (RA170)			Målestokk	1:50 (A1)	1:100 (A3)	Format A1
SYSTEMSKJEMA VVS-ANLEGG			Oppdragsleder:		Svein Erik Bakke	
			Oppdragsnr.		147421	
SWECO Norge AS FORNEBUDVEIEN 11 1327 LYSAKER TLF: 67 12 80 00 FAX: 67 12 58 40			Disiplin:	V	Løpenummer:	300
					Status:	B
					Rev:	