

Marienlyst Idrettspark

Anleggsdel : Kunstisbane

Prosjektnummer : T231002A

Kunde : Drammen kommune

Utført av : Tore krok Nielsen

Dato : 02.10.2023

Prosjektbeskrivelse:

64 stk. lyskastere - 1505,9W

- Hjørnemaster - 9 lyskastere
 - Midtmaster - 14 lyskastere
-

- Installert effekt (fullt nivå): 96,378 kW
 - Innregulert effekt - Hurtigløp Skøyter 200 lx: 35,236 kW
 - Innregulert effekt - Bandy 750 lx: 93,968 kW
 - Innregulert effekt - Fotball 350 lx: 49,396 kW
 - Innregulert effekt - Fotball 200 lx: 26,804 kW
 - Innregulert effekt - 7'erbane 200 lx: 13,101 kW
-

I lysberegningen er det kun benyttet asymmetriske lyskastere tenkt montert uten oppvipp.

Følgende verdier er beregnet basert på laboratoriemålinger av armaturer og referanselyskilder. I praksis kan avvik forekomme.

Garantikrav for armaturdata er ekskludert.

Relux og armaturprodusentene tar intet ansvar for følgeskader og skader påført brukeren eller tredjepart.

Innhold

Forside	1
Innhold	2
1 Armaturdata	
1.1 Philips Lighting, BVP528 OUT T35 1xLED2590-4S/740/740 E3/... ()	
1.1.1 Dataark	4
1.2 Philips Lighting, BVP528 OUT T35 1xLED2590-4S/740/740 E3/... ()	
1.2.1 Dataark	5
2 Alt lys på	
2.1 Beskrivelse, Alt lys på	
2.1.1 Armaturdata/Romobjekter	6
2.1.2 Planvisning	8
2.1.3 3D visning, Vis 1	9
2.2 Sammendrag, Alt lys på	
2.2.1 Resultatoversikt, Fotball PA 105 x 66m	10
2.2.2 Resultatoversikt, Bandy - PA 100 x 60m	12
2.2.3 Resultatoversikt, 7'erbane	14
2.2.4 Resultatoversikt, Hurtigløp - Skøyter	16
2.2.5 Resultatoversikt, Full Stadion	18
2.2.6 Resultatoversikt, Indre bane	20
2.3 Beregningsresultat, Alt lys på	
2.3.1 3D luminans, Vis 1	22
2.3.2 3D Fargeskala, Vis 1 (E)	23
3 Hurtigløp - Skøyter - 200 lx	
3.1 Beskrivelse, Hurtigløp - Skøyter - 200 lx	
3.1.1 Armaturdata/Romobjekter	24
3.1.2 Planvisning	28
3.1.3 3D visning, Vis 1	29
3.2 Sammendrag, Hurtigløp - Skøyter - 200 lx	
3.2.1 Resultatoversikt, Hurtigløp - Skøyter	30
3.3 Beregningsresultat, Hurtigløp - Skøyter - 200 lx	
3.3.1 3D luminans, Vis 1	32
3.3.2 3D Fargeskala, Vis 1 (E)	33
4 Bandy - 750 lx	
4.1 Beskrivelse, Bandy - 750 lx	
4.1.1 Armaturdata/Romobjekter	34
4.1.2 Planvisning	37
4.1.3 3D visning, Vis 1	38
4.2 Sammendrag, Bandy - 750 lx	
4.2.1 Resultatoversikt, Bandy - PA 100 x 60m	39
4.3 Beregningsresultat, Bandy - 750 lx	
4.3.1 3D luminans, Vis 1	41
4.3.2 3D Fargeskala, Vis 1 (E)	42
5 Fotball - 350 lx	
5.1 Beskrivelse, Fotball - 350 lx	
5.1.1 Armaturdata/Romobjekter	43
5.1.2 Planvisning	46
5.1.3 3D visning, Vis 1	47
5.2 Sammendrag, Fotball - 350 lx	
5.2.1 Resultatoversikt, Fotball PA 105 x 66m	48
5.3 Beregningsresultat, Fotball - 350 lx	
5.3.1 3D luminans, Vis 1	50
5.3.2 3D Fargeskala, Vis 1 (E)	51
6 Fotball - 200 lx	

Innhold

6.1	Beskrivelse, Fotball - 200 lx	
6.1.1	Armaturodata/Romobjekter	52
6.1.2	Planvisning	55
6.1.3	3D visning, Vis 1	56
6.2	Sammendrag, Fotball - 200 lx	
6.2.1	Resultatoversikt, Fotball PA 105 x 66m	57
6.3	Beregningsresultat, Fotball - 200 lx	
6.3.1	3D luminans, Vis 1	59
6.3.2	3D Fargeskala, Vis 1 (E)	60
7	7'erbane - 200 lx	
7.1	Beskrivelse, 7'erbane - 200 lx	
7.1.1	Armaturodata/Romobjekter	61
7.1.2	Planvisning	64
7.1.3	3D visning, Vis 1	65
7.2	Sammendrag, 7'erbane - 200 lx	
7.2.1	Resultatoversikt, 7'erbane	66
7.3	Beregningsresultat, 7'erbane - 200 lx	
7.3.1	3D luminans, Vis 1	68
7.3.2	3D Fargeskala, Vis 1 (E)	69

Objekt : Marienlyst Idrettspark
 Anleggsdel : Kunstisbane
 Prosjektnummer : T231002A
 Dato : 02.10.2023

1 Armaturdata

1.1 Philips Lighting, BVP528 OUT T35 1xLED2590-4S/740/740 E3/... ()

1.1.1 Dataark

Fabrikanter: Philips Lighting

other BVP528 OUT T35 1xLED2590-4S/740/740 E3/D4I A65-NB

Armaturdata

Armaturvirkningsgrad : 81%
 Armaturens lysutbytte : 139.31 lm/W
 Klassifisering : A30 ↓100.0% ↑0.0%
 CIE Flux Codes : 31 73 99 100 81
 Blending : G*3 / D1
 Effekt : 1505.9 W
 Lysfluks : 209790 lm

Bestykket med

Antall : 1
 Betegnelse : LED2590-4S/740
 Farge : 740
 Lysfluks : 259000 lm
 Fargegjengivelse : 70

Dimensjoner : 650 mm x 560 mm x 120 mm

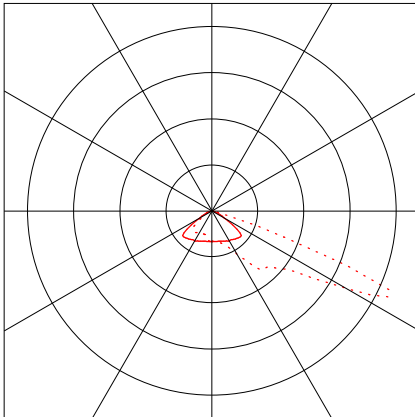

Objekt : Marienlyst Idrettspark
Anleggsdel : Kunstisbane
Prosjektnummer : T231002A
Dato : 02.10.2023

1 Armaturdata

1.2 Philips Lighting, BVP528 OUT T35 1xLED2590-4S/740/740 E3/... ()

1.2.1 Dataark

Fabrikat: Philips Lighting

other BVP528 OUT T35 1xLED2590-4S/740/740 E3/D4I A55-MB

Armaturdata

Armaturvirkningsgrad : 83%
Armaturens lysutbytte : 142.75 lm/W
Klassifisering : A40 ↓100.0% ↑0.0%
CIE Flux Codes : 40 81 99 100 83
Blending : G*6 / D2
Effekt : 1505.9 W
Lysfluks : 214970 lm

Bestykket med

Antall : 1
Betegnelse : LED2590-4S/740
Farge : 740
Lysfluks : 259000 lm
Fargegjengivelse : 70

Dimensjoner : 650 mm x 560 mm x 120 mm

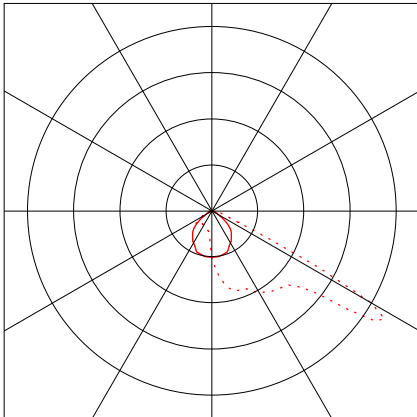



2 Alt lys på

2.1 Beskrivelse, Alt lys på

2.1.1 Armaturdata/Romobjekter

Produktspesifikasjoner:

Type Ant.\Prod.

		Philips Lighting	
1	56 x	Bestillingsnr.	:
		Armaturnavn	: BVP528 OUT T35 1xLED2590-4S/740/740 E3/D4I A65-NB
		Bestykning	: 1 x LED2590-4S/740 1505.9 W / 259000 lm
2	8 x	Bestillingsnr.	:
		Armaturnavn	: BVP528 OUT T35 1xLED2590-4S/740/740 E3/D4I A55-MB
		Bestykning	: 1 x LED2590-4S/740 1505.9 W / 259000 lm

Nr.	Midtpunkt			Rotasjonsvinkel			Orienteringspunktkoordinater		
	X [m]	Y [m]	Z [m]	Z [°]	C0 [°]	C90 [°]	Xa [m]	Ya [m]	Za [m]
Philips Lighting BVP528 OUT T35 1xLED2590-4S/740/740 E3/D4I A65-NB									
1.1	-0.35	-36.50	29.34	0.00	0.00	0.00	-0.35	26.42	0.00
1.2	-0.35	36.50	29.34	180.00	0.00	0.00	-0.35	-26.42	0.00
1.3	0.35	-36.50	29.34	0.00	0.00	0.00	0.35	26.42	0.00
1.4	0.35	36.50	29.34	180.00	0.00	0.00	0.35	-26.42	0.00
4.1	-1.05	-36.75	29.34	0.00	0.00	0.00	-1.05	26.17	0.00
4.2	-1.05	36.75	29.34	180.00	0.00	0.00	-1.05	-26.17	0.00
4.3	1.05	-36.75	29.34	0.00	0.00	0.00	1.05	26.17	0.00
4.4	1.05	36.75	29.34	180.00	0.00	0.00	1.05	-26.17	0.00
2.1	-57.15	-36.55	29.34	0.00	0.00	0.00	-57.15	26.37	0.00
2.2	-57.15	36.55	29.34	180.00	0.00	0.00	-57.15	-26.37	0.00
2.3	57.15	-36.55	29.34	0.00	0.00	0.00	57.15	26.37	0.00
2.4	57.15	36.55	29.34	180.00	0.00	0.00	57.15	-26.37	0.00
3.1	-57.85	-36.55	29.34	0.00	0.00	0.00	-57.85	26.37	0.00
3.2	-57.85	36.55	29.34	180.00	0.00	0.00	-57.85	-26.37	0.00
3.3	57.85	-36.55	29.34	0.00	0.00	0.00	57.85	26.37	0.00
3.4	57.85	36.55	29.34	180.00	0.00	0.00	57.85	-26.37	0.00
5.1	-1.75	-37.20	29.34	0.00	0.00	0.00	-1.75	25.72	0.00
5.2	-1.75	37.20	29.34	180.00	0.00	0.00	-1.75	-25.72	0.00
5.3	1.75	-37.20	29.34	0.00	0.00	0.00	1.75	25.72	0.00
5.4	1.75	37.20	29.34	180.00	0.00	0.00	1.75	-25.72	0.00
6.1	-2.25	-37.95	29.34	0.00	0.00	0.00	-2.25	24.97	0.00
6.2	-2.25	37.95	29.34	180.00	0.00	0.00	-2.25	-24.97	0.00
6.3	2.25	-37.95	29.34	0.00	0.00	0.00	2.25	24.97	0.00
6.4	2.25	37.95	29.34	180.00	0.00	0.00	2.25	-24.97	0.00
7.1	-58.50	-36.75	29.34	20.00	0.00	0.00	-80.02	22.38	0.00
7.2	-58.50	36.75	29.34	160.00	0.00	0.00	-80.02	-22.38	0.00
7.3	58.50	-36.75	29.34	340.00	0.00	0.00	80.02	22.38	0.00
7.4	58.50	36.75	29.34	200.00	0.00	0.00	80.02	-22.38	0.00
8.1	-56.50	-36.75	29.34	0.00	0.00	0.00	-56.50	26.17	0.00
8.2	-56.50	36.75	29.34	180.00	0.00	0.00	-56.50	-26.17	0.00
8.3	56.50	-36.75	29.34	0.00	0.00	0.00	56.50	26.17	0.00
8.4	56.50	36.75	29.34	180.00	0.00	0.00	56.50	-26.17	0.00
9.1	-59.10	-37.10	29.34	20.00	0.00	0.00	-80.62	22.03	0.00
9.2	-59.10	37.10	29.34	160.00	0.00	0.00	-80.62	-22.03	0.00
9.3	59.10	-37.10	29.34	340.00	0.00	0.00	80.62	22.03	0.00

2 Alt lys på

2.1 Beskrivelse, Alt lys på

2.1.1 Armaturdata/Romobjekter

9.4	59.10	37.10	29.34	200.00	0.00	0.00	80.62	-22.03	0.00
10.1	-55.85	-37.15	29.34	0.00	0.00	0.00	-55.85	25.77	0.00
10.2	-55.85	37.15	29.34	180.00	0.00	0.00	-55.85	-25.77	0.00
10.3	55.85	-37.15	29.34	0.00	0.00	0.00	55.85	25.77	0.00
10.4	55.85	37.15	29.34	180.00	0.00	0.00	55.85	-25.77	0.00
12.1	-55.30	-37.90	29.34	0.00	0.00	0.00	-55.30	25.02	0.00
12.2	-55.30	37.90	29.34	180.00	0.00	0.00	-55.30	-25.02	0.00
12.3	55.30	-37.90	29.34	0.00	0.00	0.00	55.30	25.02	0.00
12.4	55.30	37.90	29.34	180.00	0.00	0.00	55.30	-25.02	0.00
16.1	-0.35	-37.20	28.24	0.00	0.00	0.00	-0.35	23.36	0.00
16.2	-0.35	37.20	28.24	180.00	0.00	0.00	-0.35	-23.36	0.00
16.3	0.35	-37.20	28.24	0.00	0.00	0.00	0.35	23.36	0.00
16.4	0.35	37.20	28.24	180.00	0.00	0.00	0.35	-23.36	0.00
17.1	-1.05	-37.45	29.34	0.00	0.00	0.00	-1.05	25.47	0.00
17.2	-1.05	37.45	29.34	180.00	0.00	0.00	-1.05	-25.47	0.00
17.3	1.05	-37.45	29.34	0.00	0.00	0.00	1.05	25.47	0.00
17.4	1.05	37.45	29.34	180.00	0.00	0.00	1.05	-25.47	0.00
18.1	-1.55	-38.15	29.34	0.00	0.00	0.00	-1.55	24.77	0.00
18.2	-1.55	38.15	29.34	180.00	0.00	0.00	-1.55	-24.77	0.00
18.3	1.55	-38.15	29.34	0.00	0.00	0.00	1.55	24.77	0.00
18.4	1.55	38.15	29.34	180.00	0.00	0.00	1.55	-24.77	0.00

Philips Lighting BVP528 OUT T35 1xLED2590-4S/740/740 E3/D4I A55-MB

14.1	-55.05	-38.65	29.34	0.00	0.00	0.00	-55.05	8.30	0.00
14.2	-55.05	38.65	29.34	180.00	0.00	0.00	-55.05	-8.30	0.00
14.3	55.05	-38.65	29.34	0.00	0.00	0.00	55.05	8.30	0.00
14.4	55.05	38.65	29.34	180.00	0.00	0.00	55.05	-8.30	0.00
15.1	-55.05	-39.40	29.34	0.00	0.00	0.00	-55.05	7.55	0.00
15.2	-55.05	39.40	29.34	180.00	0.00	0.00	-55.05	-7.55	0.00
15.3	55.05	-39.40	29.34	0.00	0.00	0.00	55.05	7.55	0.00
15.4	55.05	39.40	29.34	180.00	0.00	0.00	55.05	-7.55	0.00

Konstruksjonsobjekt

Virtuelt beregningsfelt

Nr.	xm[m]	ym[m]	zm[m]	Lengde	Bredde	z akse	Rotasjonsvinkel	
							lengdeakse	tverrakse
Fotball PA 105 x 66m								
m 3	0.00	0.00	0.00	105.00	66.00	0.00	0.00	0.00
Bandy - PA 100 x 60m								
m 4	-50.00	-30.00	0.00	100.00	60.00	0.00	0.00	0.00
7'erbane								
m 5	52.50	-33.00	0.00	36.50	66.00	0.00	0.00	0.00
Hurtigløp - Skøyter								
	-115.70	-59.10	0.00	178.17	68.00	0.00	0.00	0.00
Full Stadion								
	-115.70	-59.10	0.00	178.17	68.00	0.00	0.00	0.00
Indre bane								
	-115.70	-59.10	0.00	152.17	42.00	0.00	0.00	0.00

2.1 Beskrivelse, Alt lys på

2.1.2 Planvisning

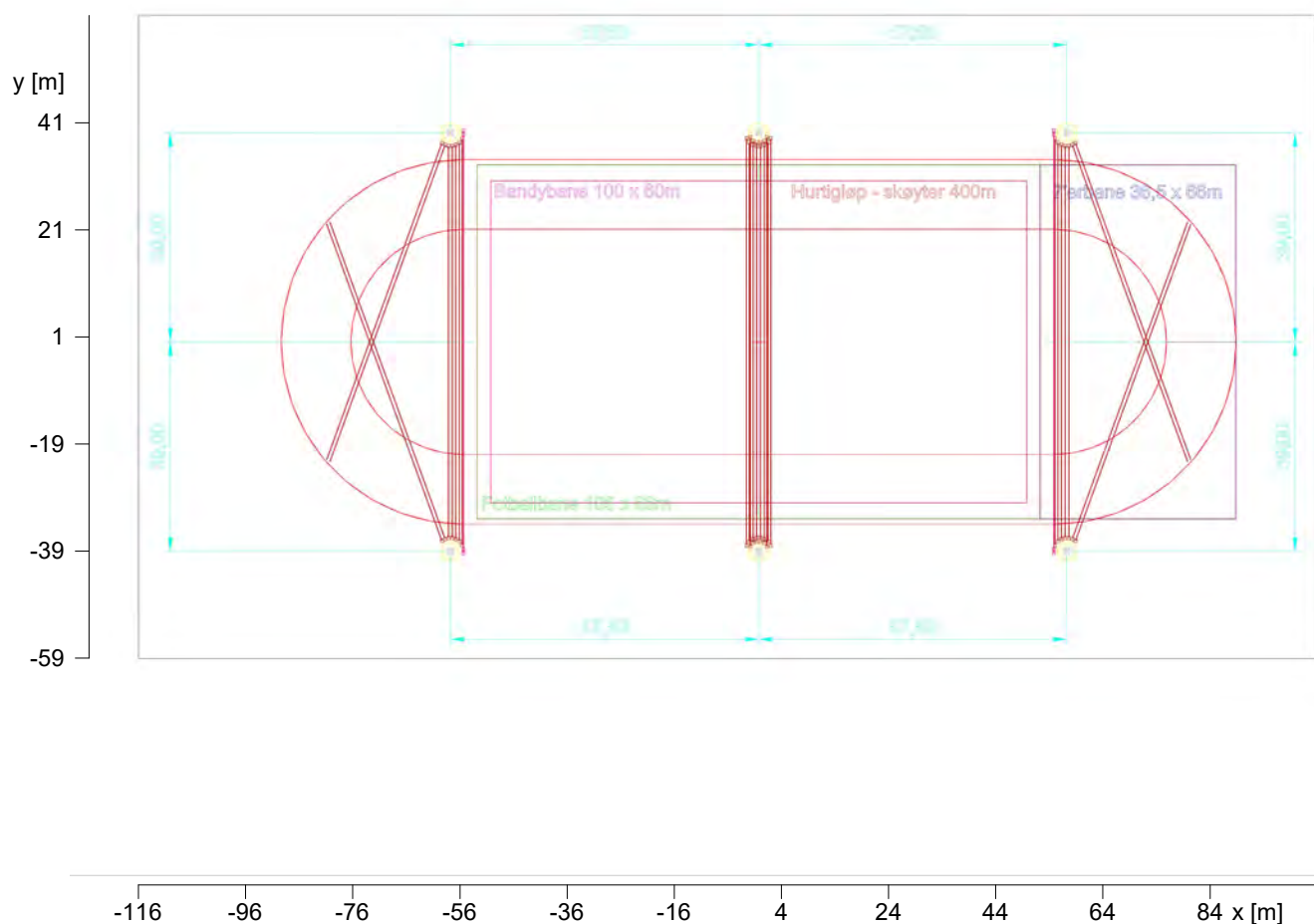

2.1 Beskrivelse, Alt lys på

2.1.3 3D visning, Vis 1

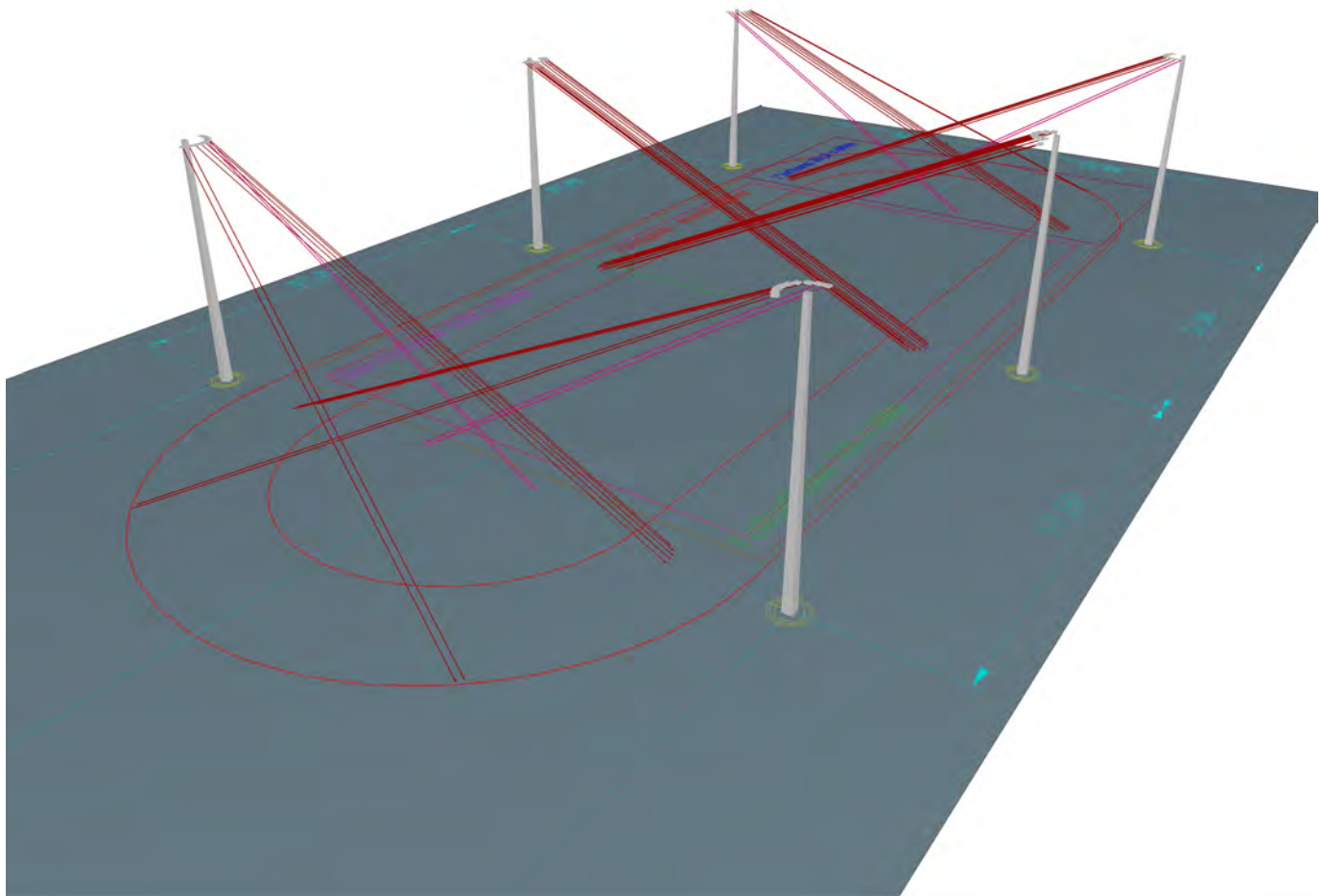

2 Alt lys på

2.2 Sammendrag, Alt lys på

2.2.1 Resultatoversikt, Fotball PA 105 x 66m

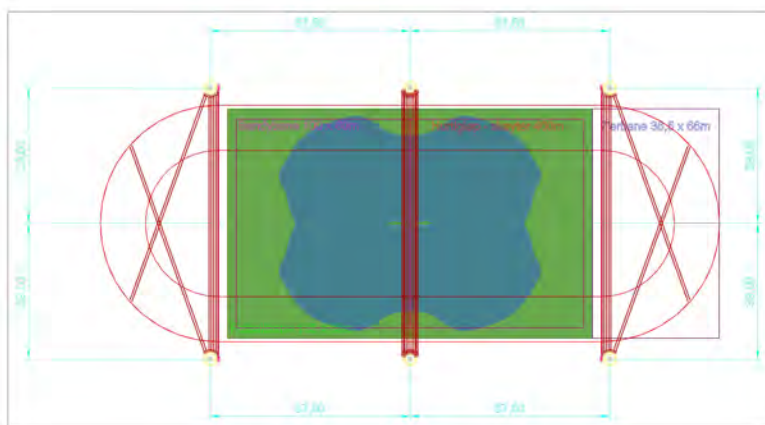

-116 -96 -76 -56 -36 -16 4 24 44 64 84 x [m]

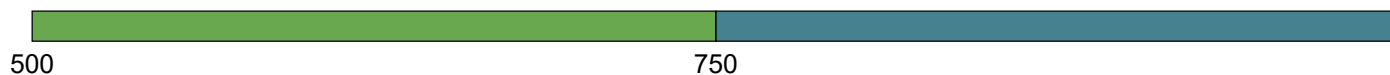

Belysningsstyrke [lx]

Generell

Anvendt beregningsalgoritme	Direkteandel
Beregningsflatens høyde	0.00 m
Vedlikeholdsfaktor	0.85

Total lysfluks	16576000 lm
Totaleffekt	96377.5 W
Totaleffekt per areal (26377.42 m ²)	3.65 W/m ²
Upward light ratio (ULR)	0.00

Belysningsstyrke

Gjennomsnittlig belysningsstyrke	\bar{E}_m	748 lx
Laveste belysningsstyrke	E_{min}	544 lx
Største belysningsstyrke	E_{max}	933 lx
Jevnhet U_o	E_{min}/\bar{E}_m	1:1.37 (0.73)
Jevnhet U_d	E_{min}/E_{max}	1:1.71 (0.58)

RG-Tabell

1.47 cd/m ² , 880 lx, $\rho = 15\%$ (-2°)	
RG,max	46.4 (h=1.60m)

Type Ant.\Prod.

	1	56 x	Philips Lighting
			Bestillingsnr. :
			Armaturnavn : BVP528 OUT T35 1xLED2590-4S/740/740 E3/D4I A65-NB
			Bestykning : 1 x LED2590-4S/740 1505.9 W / 259000 lm

ULR verdiene har blitt beregnet uten påvirkning av andre objekter.

Objekt : Marienlyst Idrettspark
Anleggsdel : Kunstisbane
Prosjektnummer : T231002A
Dato : 02.10.2023

2 Alt lys på

2.2 Sammendrag, Alt lys på

2.2.1 Resultatoversikt, Fotball PA 105 x 66m

2	8 x	Bestillingsnr.	:	
		Armaturnavn	:	BVP528 OUT T35 1xLED2590-4S/740/740 E3/D4I A55-MB
		Bestykning	:	1 x LED2590-4S/740 1505.9 W / 259000 lm

2.2 Sammendrag, Alt lys på

2.2.2 Resultatoversikt, Bandy - PA 100 x 60m

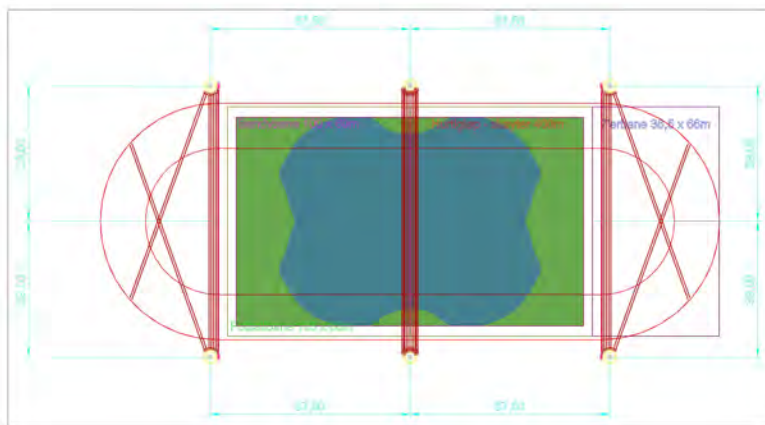

-116 -96 -76 -56 -36 -16 4 24 44 64 84 x [m]

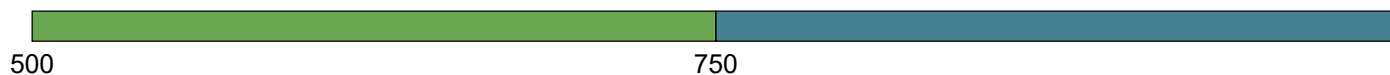

Belysningsstyrke [lx]

Generell

Anvendt beregningsalgoritme	Direkteandel
Beregningsflatens høyde	0.00 m
Vedlikeholdsfaktor	0.85

Total lysfluks	16576000 lm
Totaleffekt	96377.5 W
Totaleffekt per areal (26377.42 m ²)	3.65 W/m ²
Upward light ratio (ULR)	0.00

Belysningsstyrke

Gjennomsnittlig belysningsstyrke	\bar{E}_m	767 lx
Laveste belysningsstyrke	E_{min}	575 lx
Største belysningsstyrke	E_{max}	923 lx
Jevnhet U_o	E_{min}/\bar{E}_m	1:1.33 (0.75)
Jevnhet U_d	E_{min}/E_{max}	1:1.6 (0.62)

RG-Tabell

6.03 cd/m ² , 903 lx, $\rho = 60\%$ (-2°)	
RG,max	33.1 (h=1.60m)

Type Ant.\Prod.

	1	56 x	Philips Lighting
			Bestillingsnr. :
			Armaturnavn : BVP528 OUT T35 1xLED2590-4S/740/740 E3/D4I A65-NB
			Bestykning : 1 x LED2590-4S/740 1505.9 W / 259000 lm

ULR verdiene har blitt beregnet uten påvirkning av andre objekter.

Objekt : Marienlyst Idrettspark
Anleggsdel : Kunstisbane
Prosjektnummer : T231002A
Dato : 02.10.2023

2.2 Sammendrag, Alt lys på

2.2.2 Resultatoversikt, Bandy - PA 100 x 60m

2	8 x	Bestillingsnr.	:	
		Armaturnavn	:	BVP528 OUT T35 1xLED2590-4S/740/740 E3/D4I A55-MB
		Bestykning	:	1 x LED2590-4S/740 1505.9 W / 259000 lm

2.2 Sammendrag, Alt lys på

2.2.3 Resultatoversikt, 7'erbane

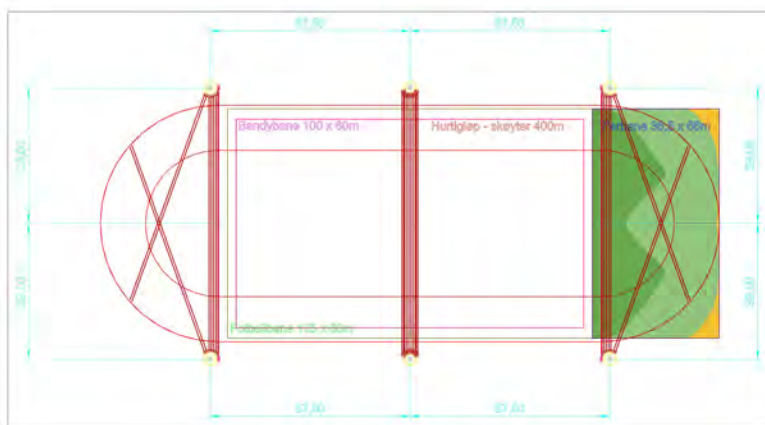

-116 -96 -76 -56 -36 -16 4 24 44 64 84 x [m]



Belysningsstyrke [lx]

Generell

Anvendt beregningsalgoritme	Direkteandel
Beregningsflatens høyde	0.00 m
Vedlikeholdsfaktor	0.85

Total lysfluks	16576000 lm
Totaleffekt	96377.5 W
Totaleffekt per areal (26377.42 m ²)	3.65 W/m ²
Upward light ratio (ULR)	0.00

Belysningsstyrke

Gjennomsnittlig belysningsstyrke	\bar{E}_m	460 lx
Laveste belysningsstyrke	E_{min}	234 lx
Største belysningsstyrke	E_{max}	599 lx
Jevnhet U_o	E_{min}/\bar{E}_m	1:1.97 (0.51)
Jevnhet U_d	E_{min}/E_{max}	1:2.56 (0.39)

RG-Tabell

0.91 cd/m ² , 542 lx, $\rho = 15\%$ (-2°)	
RG,max	43.9 (h=1.60m)

Type Ant.\Prod.

1 56 x	Philips Lighting	
	Bestillingsnr.	:
	Armaturnavn	: BVP528 OUT T35 1xLED2590-4S/740/740 E3/D4I A65-NB
	Bestykning	: 1 x LED2590-4S/740 1505.9 W / 259000 lm

ULR verdiene har blitt beregnet uten påvirkning av andre objekter.

Objekt : Marienlyst Idrettspark
Anleggsdel : Kunstisbane
Prosjektnummer : T231002A
Dato : 02.10.2023

2.2 Sammendrag, Alt lys på

2.2.3 Resultatoversikt, 7'erbane

2	8 x	Bestillingsnr.	:	
		Armaturnavn	:	BVP528 OUT T35 1xLED2590-4S/740/740 E3/D4I A55-MB
		Bestykning	:	1 x LED2590-4S/740 1505.9 W / 259000 lm

2.2 Sammendrag, Alt lys på

2.2.4 Resultatoversikt, Hurtigløp - Skøyter

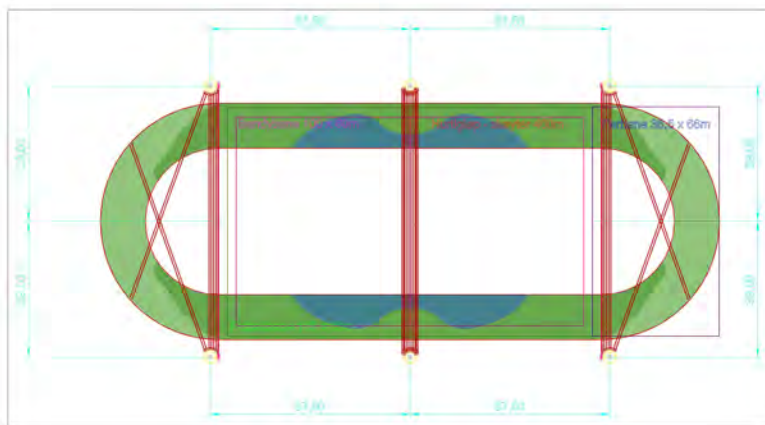

-116 -96 -76 -56 -36 -16 4 24 44 64 84 x [m]



Belysningsstyrke [lx]

Generell

Anvendt beregningsalgoritme	Direkteandel
Beregningsflatens høyde	0.00 m
Vedlikeholdsfaktor	0.85

Total lysfluks	16576000 lm
Totaleffekt	96377.5 W
Totaleffekt per areal (26377.42 m ²)	3.65 W/m ² (0.61 W/m ² /100lx)
Upward light ratio (ULR)	0.00

Belysningsstyrke

Gjennomsnittlig belysningsstyrke	\bar{E}_m	596 lx
Laveste belysningsstyrke	E_{min}	300 lx
Største belysningsstyrke	E_{max}	844 lx
Jevnhet U_o	E_{min}/\bar{E}_m	1:1.99 (0.5)
Jevnhet U_d	E_{min}/E_{max}	1:2.81 (0.36)

RG-Tabell

4.69 cd/m ² , 701 lx, $\rho = 60\%$ (-2°)	
RG,max	35.7 (h=1.60m)

Type Ant.\Prod.

	1	56 x	Philips Lighting
			Bestillingsnr. :
			Armaturnavn : BVP528 OUT T35 1xLED2590-4S/740/740 E3/D4I A65-NB
			Bestykning : 1 x LED2590-4S/740 1505.9 W / 259000 lm

ULR verdiene har blitt beregnet uten påvirkning av andre objekter.

Objekt : Marienlyst Idrettspark
Anleggsdel : Kunstisbane
Prosjektnummer : T231002A
Dato : 02.10.2023

2.2 Sammendrag, Alt lys på

2.2.4 Resultatoversikt, Hurtigløp - Skøyter

2	8 x	Bestillingsnr.	:	
		Armaturnavn	:	BVP528 OUT T35 1xLED2590-4S/740/740 E3/D4I A55-MB
		Bestykning	:	1 x LED2590-4S/740 1505.9 W / 259000 lm

2.2 Sammendrag, Alt lys på

2.2.5 Resultatoversikt, Full Stadion

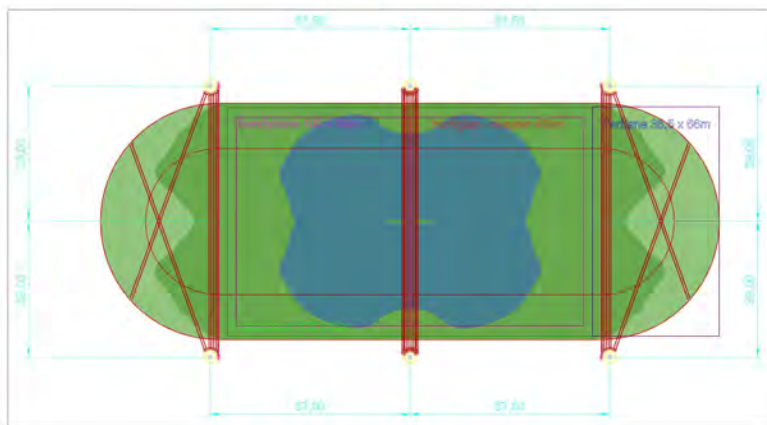

-116 -96 -76 -56 -36 -16 4 24 44 64 84 x [m]



Belysningsstyrke [lx]

Generell

Anvendt beregningsalgoritme	Direkteandel
Beregningsflatens høyde	0.00 m
Vedlikeholdsfaktor	0.85
Total lysfluks	16576000 lm
Totaleffekt	96377.5 W
Totaleffekt per areal (26377.42 m ²)	3.65 W/m ² (0.56 W/m ² /100lx)
Upward light ratio (ULR)	0.00

Belysningsstyrke

Gjennomsnittlig belysningsstyrke	\bar{E}_m	650 lx
Laveste belysningsstyrke	E_{min}	306 lx
Største belysningsstyrke	E_{max}	931 lx
Jevnhet U_o	E_{min}/\bar{E}_m	1:2.12 (0.47)
Jevnhet U_d	E_{min}/E_{max}	1:3.04 (0.33)

RG-Tabell

1.28 cd/m ² , 765 lx, $\rho = 15\%$ (-2°)	
RG,max	47.6 (h=1.60m)

Type Ant.\Prod.

1	56 x	Philips Lighting
		Bestillingsnr. :
		Armaturnavn : BVP528 OUT T35 1xLED2590-4S/740/740 E3/D4I A65-NB
		Bestykning : 1 x LED2590-4S/740 1505.9 W / 259000 lm

ULR verdiene har blitt beregnet uten påvirkning av andre objekter.

Objekt : Marienlyst Idrettspark
Anleggsdel : Kunstisbane
Prosjektnummer : T231002A
Dato : 02.10.2023

2.2 Sammendrag, Alt lys på

2.2.5 Resultatoversikt, Full Stadion

2	8 x	Bestillingsnr.	:	
		Armaturnavn	:	BVP528 OUT T35 1xLED2590-4S/740/740 E3/D4I A55-MB
		Bestykning	:	1 x LED2590-4S/740 1505.9 W / 259000 lm

2.2 Sammendrag, Alt lys på

2.2.6 Resultatoversikt, Indre bane

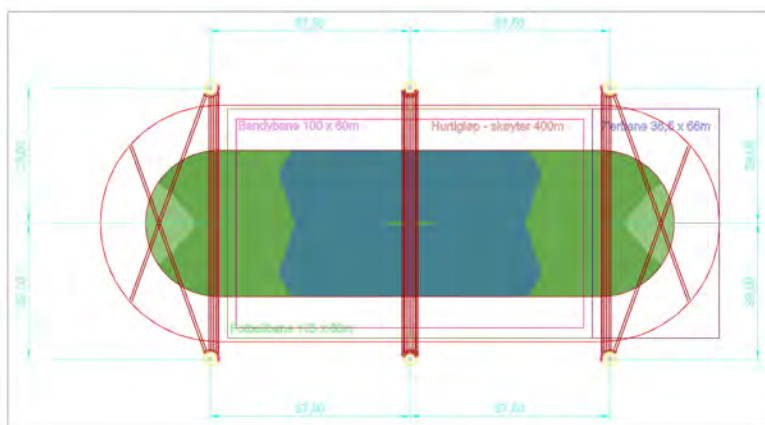

-116 -96 -76 -56 -36 -16 4 24 44 64 84 x [m]



Belysningsstyrke [lx]

Generell

Anvendt beregningsalgoritme
 Beregningsflatens høyde
 Vedlikeholdsfaktor

Direkteandel
 0.00 m
 0.85

Total lysfluks

16576000 lm

Totaleffekt

96377.5 W

Totaleffekt per areal (26377.42 m²)

3.65 W/m² (0.51 W/m²/100lx)

Upward light ratio (ULR)

0.00

Belysningsstyrke

Gjennomsnittlig belysningsstyrke \bar{E}_m

710 lx

Laveste belysningsstyrke E_{min}

423 lx

Største belysningsstyrke E_{max}

935 lx

Jevnhet U_o

E_{min}/\bar{E}_m

1:1.68 (0.6)

Jevnhet U_d

E_{min}/E_{max}

1:2.21 (0.45)

RG-Tabell

1.4 cd/m², 835 lx, $\rho = 15\%$ (-2°)

RG,max

46.7 (h=1.60m)

Type Ant.\Prod.

1 56 x



Philips Lighting

Bestillingsnr. :

Armaturnavn :

Bestykning :

:
 : BVP528 OUT T35 1xLED2590-4S/740/740 E3/D4I A65-NB
 : 1 x LED2590-4S/740 1505.9 W / 259000 lm

ULR verdiene har blitt beregnet uten påvirkning av andre objekter.

Objekt : Marienlyst Idrettspark
Anleggsdel : Kunstisbane
Prosjektnummer : T231002A
Dato : 02.10.2023

2.2 Sammendrag, Alt lys på

2.2.6 Resultatoversikt, Indre bane

2	8 x	Bestillingsnr.	:	
		Armaturnavn	:	BVP528 OUT T35 1xLED2590-4S/740/740 E3/D4I A55-MB
		Bestykning	:	1 x LED2590-4S/740 1505.9 W / 259000 lm

2 Alt lys på

2.3 Beregningsresultat, Alt lys på

2.3.1 3D luminans, Vis 1

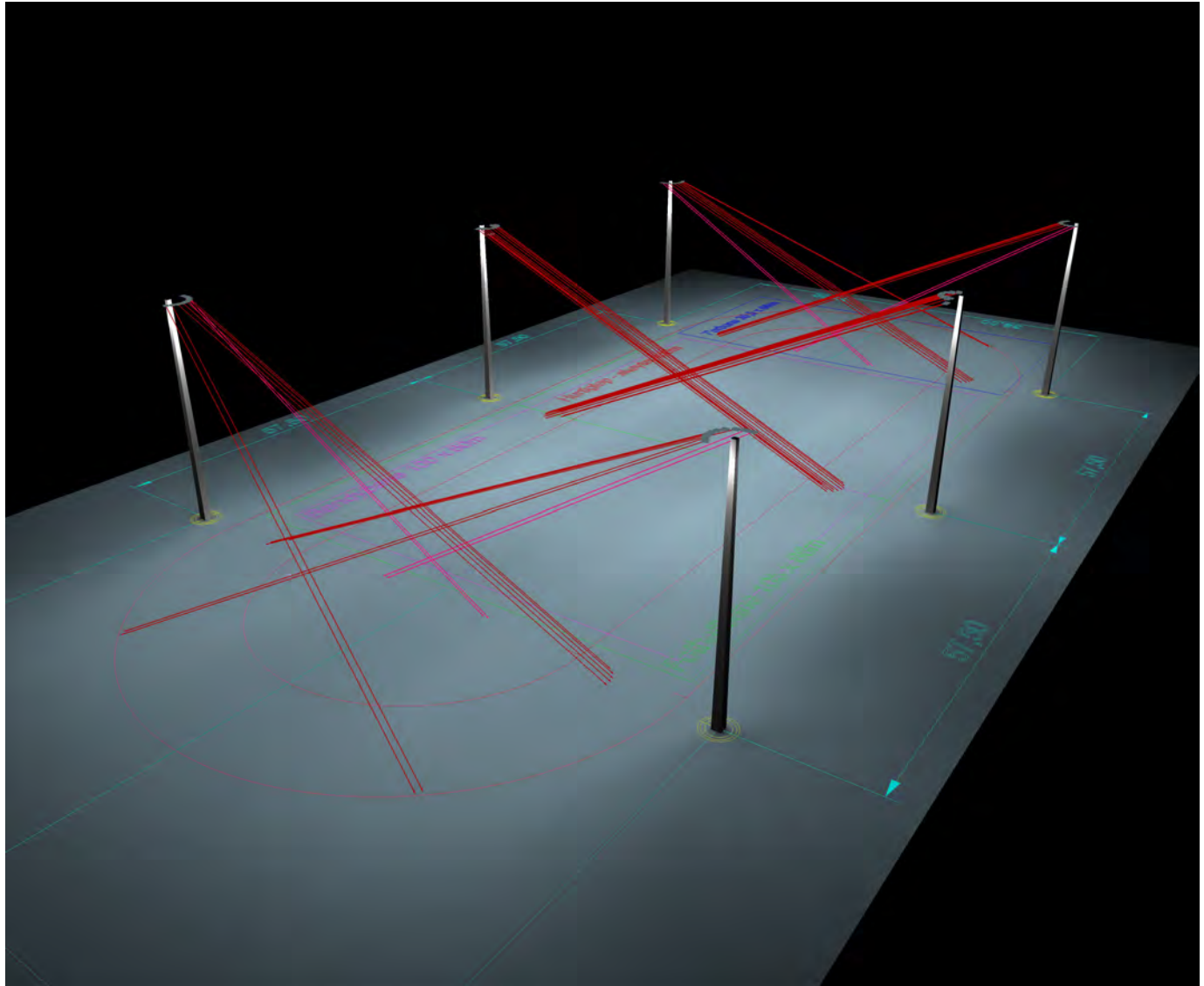

2.3 Beregningsresultat, Alt lys på

2.3.2 3D Fargeskala, Vis 1 (E)

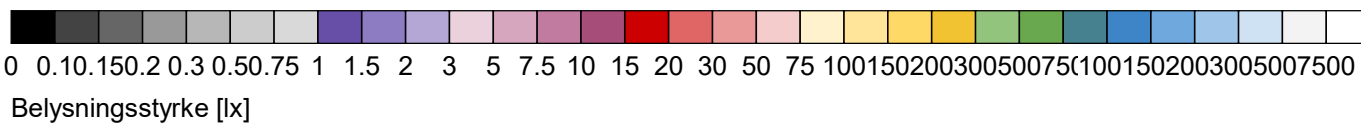
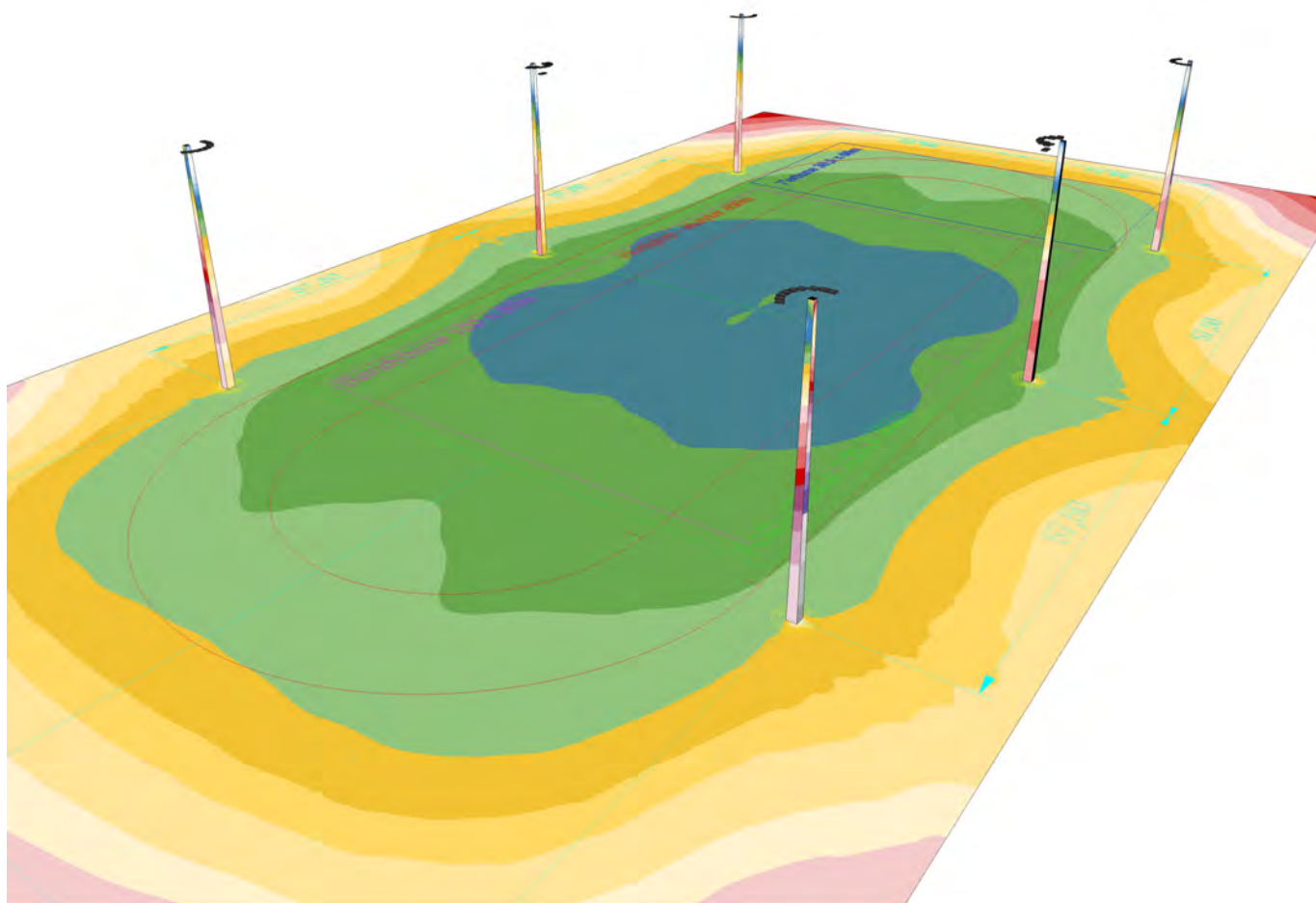



3 Hurtigløp - Skøyter - 200 lx

3.1 Beskrivelse, Hurtigløp - Skøyter - 200 lx

3.1.1 Armaturdata/Romobjekter

Produktspesifikasjoner:

Type Ant.\Prod.

		Philips Lighting	
1	56 x	Bestillingsnr.	:
		Armaturnavn	: BVP528 OUT T35 1xLED2590-4S/740/740 E3/D4I A65-NB
		Bestykning	: 1 x LED2590-4S/740 1505.9 W / 259000 lm
2	8 x	Bestillingsnr.	:
		Armaturnavn	: BVP528 OUT T35 1xLED2590-4S/740/740 E3/D4I A55-MB
		Bestykning	: 1 x LED2590-4S/740 1505.9 W / 259000 lm

Nr.	Midtpunkt			Rotasjonsvinkel			Orienteringspunktkoordinater		
	X [m]	Y [m]	Z [m]	Z [°]	C0 [°]	C90 [°]	Xa [m]	Ya [m]	Za [m]
Philips Lighting BVP528 OUT T35 1xLED2590-4S/740/740 E3/D4I A65-NB									
1.1	-0.35	-36.50	29.34	0.00	0.00	0.00	-0.35	26.42	0.00
1.2	-0.35	36.50	29.34	180.00	0.00	0.00	-0.35	-26.42	0.00
1.3	0.35	-36.50	29.34	0.00	0.00	0.00	0.35	26.42	0.00
1.4	0.35	36.50	29.34	180.00	0.00	0.00	0.35	-26.42	0.00
4.1	-1.05	-36.75	29.34	0.00	0.00	0.00	-1.05	26.17	0.00
4.2	-1.05	36.75	29.34	180.00	0.00	0.00	-1.05	-26.17	0.00
4.3	1.05	-36.75	29.34	0.00	0.00	0.00	1.05	26.17	0.00
4.4	1.05	36.75	29.34	180.00	0.00	0.00	1.05	-26.17	0.00
2.1	-57.15	-36.55	29.34	0.00	0.00	0.00	-57.15	26.37	0.00
2.2	-57.15	36.55	29.34	180.00	0.00	0.00	-57.15	-26.37	0.00
2.3	57.15	-36.55	29.34	0.00	0.00	0.00	57.15	26.37	0.00
2.4	57.15	36.55	29.34	180.00	0.00	0.00	57.15	-26.37	0.00
3.1	-57.85	-36.55	29.34	0.00	0.00	0.00	-57.85	26.37	0.00
3.2	-57.85	36.55	29.34	180.00	0.00	0.00	-57.85	-26.37	0.00
3.3	57.85	-36.55	29.34	0.00	0.00	0.00	57.85	26.37	0.00
3.4	57.85	36.55	29.34	180.00	0.00	0.00	57.85	-26.37	0.00
5.1	-1.75	-37.20	29.34	0.00	0.00	0.00	-1.75	25.72	0.00
5.2	-1.75	37.20	29.34	180.00	0.00	0.00	-1.75	-25.72	0.00
5.3	1.75	-37.20	29.34	0.00	0.00	0.00	1.75	25.72	0.00
5.4	1.75	37.20	29.34	180.00	0.00	0.00	1.75	-25.72	0.00
6.1	-2.25	-37.95	29.34	0.00	0.00	0.00	-2.25	24.97	0.00
6.2	-2.25	37.95	29.34	180.00	0.00	0.00	-2.25	-24.97	0.00
6.3	2.25	-37.95	29.34	0.00	0.00	0.00	2.25	24.97	0.00
6.4	2.25	37.95	29.34	180.00	0.00	0.00	2.25	-24.97	0.00
7.1	-58.50	-36.75	29.34	20.00	0.00	0.00	-80.02	22.38	0.00
7.2	-58.50	36.75	29.34	160.00	0.00	0.00	-80.02	-22.38	0.00
7.3	58.50	-36.75	29.34	340.00	0.00	0.00	80.02	22.38	0.00
7.4	58.50	36.75	29.34	200.00	0.00	0.00	80.02	-22.38	0.00
8.1	-56.50	-36.75	29.34	0.00	0.00	0.00	-56.50	26.17	0.00
8.2	-56.50	36.75	29.34	180.00	0.00	0.00	-56.50	-26.17	0.00
8.3	56.50	-36.75	29.34	0.00	0.00	0.00	56.50	26.17	0.00
8.4	56.50	36.75	29.34	180.00	0.00	0.00	56.50	-26.17	0.00
9.1	-59.10	-37.10	29.34	20.00	0.00	0.00	-80.62	22.03	0.00
9.2	-59.10	37.10	29.34	160.00	0.00	0.00	-80.62	-22.03	0.00
9.3	59.10	-37.10	29.34	340.00	0.00	0.00	80.62	22.03	0.00

3 Hurtigløp - Skøyter - 200 lx

3.1 Beskrivelse, Hurtigløp - Skøyter - 200 lx

3.1.1 Armaturdata/Romobjekter

9.4	59.10	37.10	29.34	200.00	0.00	0.00	80.62	-22.03	0.00
10.1	-55.85	-37.15	29.34	0.00	0.00	0.00	-55.85	25.77	0.00
10.2	-55.85	37.15	29.34	180.00	0.00	0.00	-55.85	-25.77	0.00
10.3	55.85	-37.15	29.34	0.00	0.00	0.00	55.85	25.77	0.00
10.4	55.85	37.15	29.34	180.00	0.00	0.00	55.85	-25.77	0.00
12.1	-55.30	-37.90	29.34	0.00	0.00	0.00	-55.30	25.02	0.00
12.2	-55.30	37.90	29.34	180.00	0.00	0.00	-55.30	-25.02	0.00
12.3	55.30	-37.90	29.34	0.00	0.00	0.00	55.30	25.02	0.00
12.4	55.30	37.90	29.34	180.00	0.00	0.00	55.30	-25.02	0.00
16.1	-0.35	-37.20	28.24	0.00	0.00	0.00	-0.35	23.36	0.00
16.2	-0.35	37.20	28.24	180.00	0.00	0.00	-0.35	-23.36	0.00
16.3	0.35	-37.20	28.24	0.00	0.00	0.00	0.35	23.36	0.00
16.4	0.35	37.20	28.24	180.00	0.00	0.00	0.35	-23.36	0.00
17.1	-1.05	-37.45	28.24	0.00	0.00	0.00	-1.05	23.11	0.00
17.2	-1.05	37.45	28.24	180.00	0.00	0.00	-1.05	-23.11	0.00
17.3	1.05	-37.45	28.24	0.00	0.00	0.00	1.05	23.11	0.00
17.4	1.05	37.45	28.24	180.00	0.00	0.00	1.05	-23.11	0.00
18.1	-1.55	-38.15	28.24	0.00	0.00	0.00	-1.55	22.41	0.00
18.2	-1.55	38.15	28.24	180.00	0.00	0.00	-1.55	-22.41	0.00
18.3	1.55	-38.15	28.24	0.00	0.00	0.00	1.55	22.41	0.00
18.4	1.55	38.15	28.24	180.00	0.00	0.00	1.55	-22.41	0.00

Philips Lighting BVP528 OUT T35 1xLED2590-4S/740/740 E3/D4I A55-MB

14.1	-55.05	-38.65	29.34	0.00	0.00	0.00	-55.05	8.30	0.00
14.2	-55.05	38.65	29.34	180.00	0.00	0.00	-55.05	-8.30	0.00
14.3	55.05	-38.65	29.34	0.00	0.00	0.00	55.05	8.30	0.00
14.4	55.05	38.65	29.34	180.00	0.00	0.00	55.05	-8.30	0.00
15.1	-55.05	-39.40	29.34	0.00	0.00	0.00	-55.05	7.55	0.00
15.2	-55.05	39.40	29.34	180.00	0.00	0.00	-55.05	-7.55	0.00
15.3	55.05	-39.40	29.34	0.00	0.00	0.00	55.05	7.55	0.00
15.4	55.05	39.40	29.34	180.00	0.00	0.00	55.05	-7.55	0.00

Dimmeverdier

Nr.	Phi [lm]	Phi [%]		T [K]	Rød	Farge Grønn	Blå	Hvit
Philips Lighting BVP528 OUT T35 1xLED2590-4S/740/740 E3/D4I A65-NB								
1.1	64750.00	25.00	<input type="checkbox"/>	---	1.0000	1.0000	1.0000	---
1.2	64750.00	25.00	<input type="checkbox"/>	---	1.0000	1.0000	1.0000	---
1.3	64750.00	25.00	<input type="checkbox"/>	---	1.0000	1.0000	1.0000	---
1.4	64750.00	25.00	<input type="checkbox"/>	---	1.0000	1.0000	1.0000	---
4.1	64750.00	25.00	<input type="checkbox"/>	---	1.0000	1.0000	1.0000	---
4.2	64750.00	25.00	<input type="checkbox"/>	---	1.0000	1.0000	1.0000	---
4.3	64750.00	25.00	<input type="checkbox"/>	---	1.0000	1.0000	1.0000	---
4.4	64750.00	25.00	<input type="checkbox"/>	---	1.0000	1.0000	1.0000	---
2.1	77700.00	30.00	<input type="checkbox"/>	---	1.0000	1.0000	1.0000	---
2.2	77700.00	30.00	<input type="checkbox"/>	---	1.0000	1.0000	1.0000	---
2.3	77700.00	30.00	<input type="checkbox"/>	---	1.0000	1.0000	1.0000	---
2.4	77700.00	30.00	<input type="checkbox"/>	---	1.0000	1.0000	1.0000	---
3.1	77700.00	30.00	<input type="checkbox"/>	---	1.0000	1.0000	1.0000	---

3 Hurtigløp - Skøyter - 200 lx

3.1 Beskrivelse, Hurtigløp - Skøyter - 200 lx

3.1.1 Armaturdata/Romobjekter

3.2	77700.00	30.00	<input type="checkbox"/>	---	1.0000	1.0000	1.0000	---
3.3	77700.00	30.00	<input type="checkbox"/>	---	1.0000	1.0000	1.0000	---
3.4	77700.00	30.00	<input type="checkbox"/>	---	1.0000	1.0000	1.0000	---
5.1	64750.00	25.00	<input type="checkbox"/>	---	1.0000	1.0000	1.0000	---
5.2	64750.00	25.00	<input type="checkbox"/>	---	1.0000	1.0000	1.0000	---
5.3	64750.00	25.00	<input type="checkbox"/>	---	1.0000	1.0000	1.0000	---
5.4	64750.00	25.00	<input type="checkbox"/>	---	1.0000	1.0000	1.0000	---
6.1	64750.00	25.00	<input type="checkbox"/>	---	1.0000	1.0000	1.0000	---
6.2	64750.00	25.00	<input type="checkbox"/>	---	1.0000	1.0000	1.0000	---
6.3	64750.00	25.00	<input type="checkbox"/>	---	1.0000	1.0000	1.0000	---
6.4	64750.00	25.00	<input type="checkbox"/>	---	1.0000	1.0000	1.0000	---
8.1	77700.00	30.00	<input type="checkbox"/>	---	1.0000	1.0000	1.0000	---
8.2	77700.00	30.00	<input type="checkbox"/>	---	1.0000	1.0000	1.0000	---
8.3	77700.00	30.00	<input type="checkbox"/>	---	1.0000	1.0000	1.0000	---
8.4	77700.00	30.00	<input type="checkbox"/>	---	1.0000	1.0000	1.0000	---
10.1	77700.00	30.00	<input type="checkbox"/>	---	1.0000	1.0000	1.0000	---
10.2	77700.00	30.00	<input type="checkbox"/>	---	1.0000	1.0000	1.0000	---
10.3	77700.00	30.00	<input type="checkbox"/>	---	1.0000	1.0000	1.0000	---
10.4	77700.00	30.00	<input type="checkbox"/>	---	1.0000	1.0000	1.0000	---
12.1	77700.00	30.00	<input type="checkbox"/>	---	1.0000	1.0000	1.0000	---
12.2	77700.00	30.00	<input type="checkbox"/>	---	1.0000	1.0000	1.0000	---
12.3	77700.00	30.00	<input type="checkbox"/>	---	1.0000	1.0000	1.0000	---
12.4	77700.00	30.00	<input type="checkbox"/>	---	1.0000	1.0000	1.0000	---
16.1	64750.00	25.00	<input type="checkbox"/>	---	1.0000	1.0000	1.0000	---
16.2	64750.00	25.00	<input type="checkbox"/>	---	1.0000	1.0000	1.0000	---
16.3	64750.00	25.00	<input type="checkbox"/>	---	1.0000	1.0000	1.0000	---
16.4	64750.00	25.00	<input type="checkbox"/>	---	1.0000	1.0000	1.0000	---
17.1	64750.00	25.00	<input type="checkbox"/>	---	1.0000	1.0000	1.0000	---
17.2	64750.00	25.00	<input type="checkbox"/>	---	1.0000	1.0000	1.0000	---
17.3	64750.00	25.00	<input type="checkbox"/>	---	1.0000	1.0000	1.0000	---
17.4	64750.00	25.00	<input type="checkbox"/>	---	1.0000	1.0000	1.0000	---
18.1	64750.00	25.00	<input type="checkbox"/>	---	1.0000	1.0000	1.0000	---
18.2	64750.00	25.00	<input type="checkbox"/>	---	1.0000	1.0000	1.0000	---
18.3	64750.00	25.00	<input type="checkbox"/>	---	1.0000	1.0000	1.0000	---
18.4	64750.00	25.00	<input type="checkbox"/>	---	1.0000	1.0000	1.0000	---

Philips Lighting BVP528 OUT T35 1xLED2590-4S/740/740 E3/D4I A55-MB

14.1	77700.00	30.00	<input type="checkbox"/>	---	1.0000	1.0000	1.0000	---
14.2	77700.00	30.00	<input type="checkbox"/>	---	1.0000	1.0000	1.0000	---
14.3	77700.00	30.00	<input type="checkbox"/>	---	1.0000	1.0000	1.0000	---
14.4	77700.00	30.00	<input type="checkbox"/>	---	1.0000	1.0000	1.0000	---
15.1	77700.00	30.00	<input type="checkbox"/>	---	1.0000	1.0000	1.0000	---
15.2	77700.00	30.00	<input type="checkbox"/>	---	1.0000	1.0000	1.0000	---
15.3	77700.00	30.00	<input type="checkbox"/>	---	1.0000	1.0000	1.0000	---
15.4	77700.00	30.00	<input type="checkbox"/>	---	1.0000	1.0000	1.0000	---

Konstruksjonsobjekt

Objekt : Marienlyst Idrettspark
Anleggsdel : Kunstisbane
Prosjektnummer : T231002A
Dato : 02.10.2023

3 Hurtigløp - Skøyter - 200 lx

3.1 Beskrivelse, Hurtigløp - Skøyter - 200 lx

3.1.1 Armaturodata/Romobjekter

Virtuelt beregningsfelt

Nr.	xm[m]	ym[m]	zm[m]	Lengde	Bredde	z akse	Rotasjonsvinkel	
							lengdeakse	tverrakse
Hurtigløp - Skøyter	-115.70	-59.10	0.00	178.17	68.00	0.00	0.00	0.00

3.1 Beskrivelse, Hurtigløp - Skøyter - 200 lx

3.1.3 3D visning, Vis 1

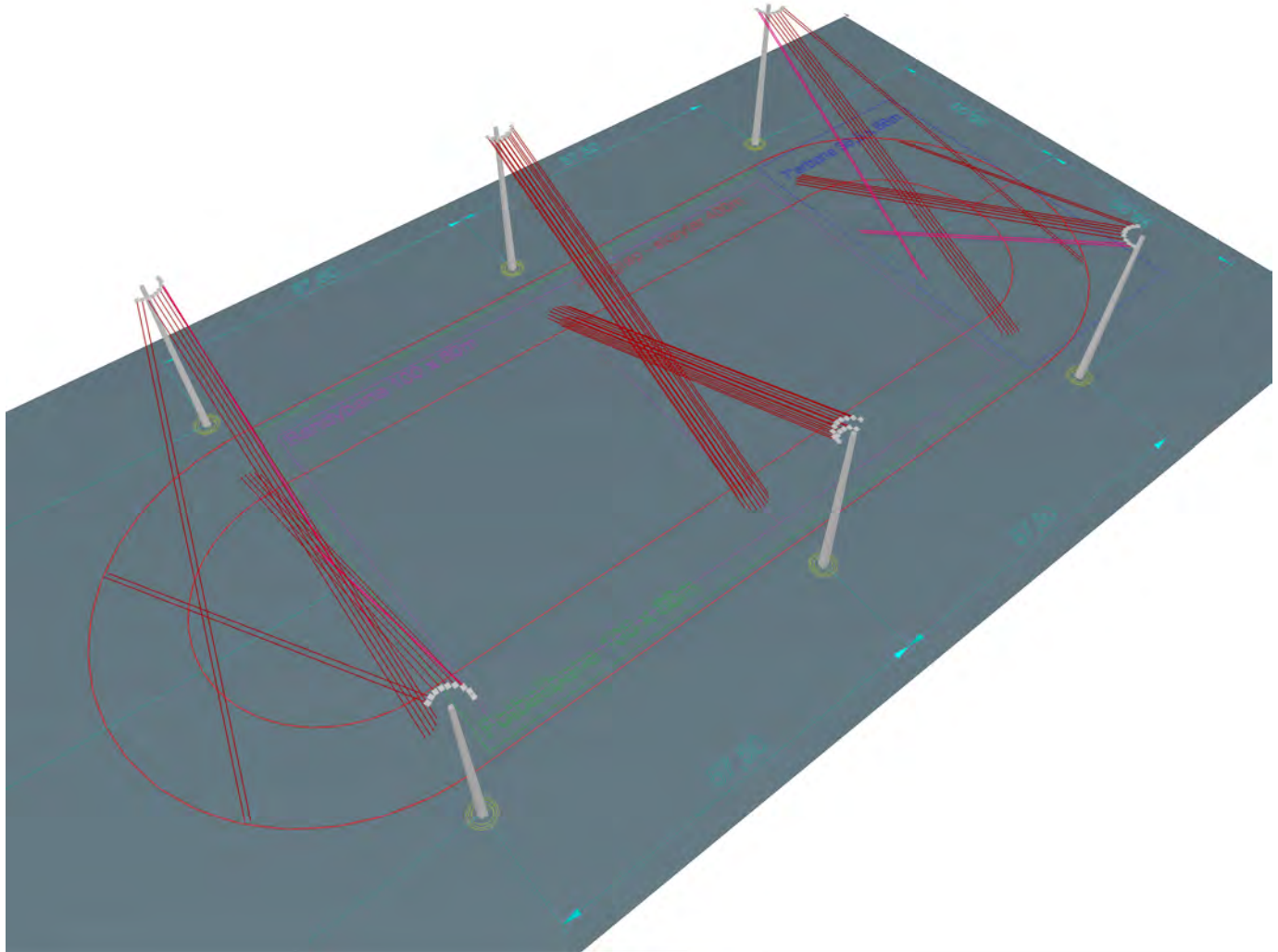

3 Hurtigløp - Skøyter - 200 lx

3.2 Sammendrag, Hurtigløp - Skøyter - 200 lx

3.2.1 Resultatoversikt, Hurtigløp - Skøyter

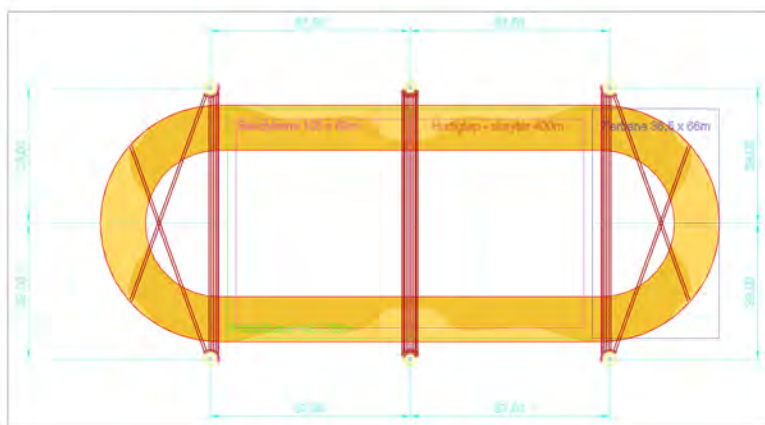

-116 -96 -76 -56 -36 -16 4 24 44 64 84 x [m]

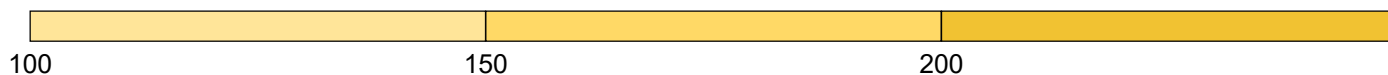

Belysningsstyrke [lx]

Generell

Anvendt beregningsalgoritme	Direkteandel
Beregningsflatens høyde	0.00 m
Vedlikeholdsfaktor	0.85
Total lysfluks	6060600 lm (36.56% dimmet)
(Luminaires have been dimmed. For details see output page "Armaturdata/Romobjekter".)	
Totaleffekt	96377.5 W
Totaleffekt per areal (26377.42 m ²)	3.65 W/m ² (1.75 W/m ² /100lx)
Upward light ratio (ULR)	0.00

Belysningsstyrke

Gjennomsnittlig belysningsstyrke	\bar{E}_m	209 lx
Laveste belysningsstyrke	E_{min}	150 lx
Største belysningsstyrke	E_{max}	244 lx
Jevnhet U_o	E_{min}/\bar{E}_m	1:1.39 (0.72)
Jevnhet U_d	E_{min}/E_{max}	1:1.63 (0.61)

RG-Tabell

1.64 cd/m ² , 246 lx, $\rho = 60\%$ (-2°)	
$R_{G,max}$	31.2 (h=1.60m)



Type Ant.\Prod.

ULR verdiene har blitt beregnet uten påvirkning av andre objekter.

3 Hurtigløp - Skøyter - 200 lx

3.2 Sammendrag, Hurtigløp - Skøyter - 200 lx

3.2.1 Resultatoversikt, Hurtigløp - Skøyter

		Philips Lighting	
1	56 x	Bestillingsnr.	:
		Armaturnavn	: BVP528 OUT T35 1xLED2590-4S/740/740 E3/D4I A65-NB
		Bestykning	: 1 x LED2590-4S/740 1505.9 W / 259000 lm
2	8 x	Bestillingsnr.	:
		Armaturnavn	: BVP528 OUT T35 1xLED2590-4S/740/740 E3/D4I A55-MB
		Bestykning	: 1 x LED2590-4S/740 1505.9 W / 259000 lm

3.3 Beregningsresultat, Hurtigløp - Skøyter - 200 lx

3.3.2 3D Fargeskala, Vis 1 (E)

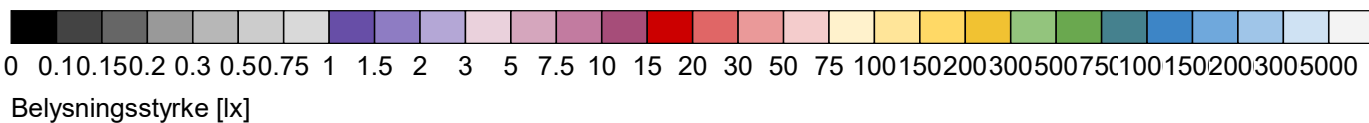
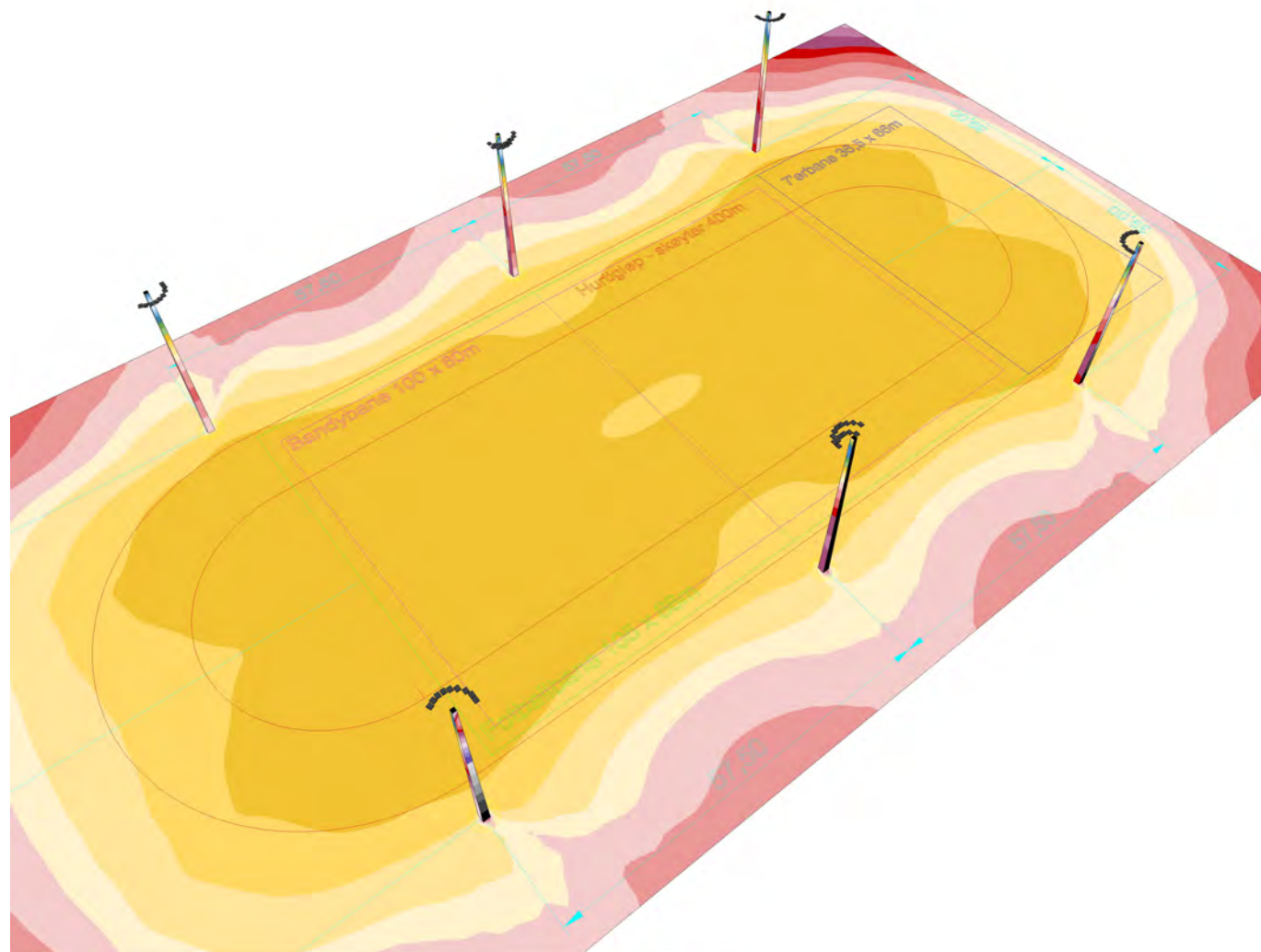



4 Bandy - 750 lx

4.1 Beskrivelse, Bandy - 750 lx

4.1.1 Armaturdata/Romobjekter

Produktspesifikasjoner:

Type Ant.\Prod.

		Philips Lighting	
1	56 x	Bestillingsnr.	:
		Armaturnavn	: BVP528 OUT T35 1xLED2590-4S/740/740 E3/D4I A65-NB
		Bestykning	: 1 x LED2590-4S/740 1505.9 W / 259000 lm
2	8 x	Bestillingsnr.	:
		Armaturnavn	: BVP528 OUT T35 1xLED2590-4S/740/740 E3/D4I A55-MB
		Bestykning	: 1 x LED2590-4S/740 1505.9 W / 259000 lm

Nr.	Midtpunkt			Rotasjonsvinkel			Orienteringspunktkoordinater		
	X [m]	Y [m]	Z [m]	Z [°]	C0 [°]	C90 [°]	Xa [m]	Ya [m]	Za [m]
Philips Lighting BVP528 OUT T35 1xLED2590-4S/740/740 E3/D4I A65-NB									
1.1	-0.35	-36.50	29.34	0.00	0.00	0.00	-0.35	26.42	0.00
1.2	-0.35	36.50	29.34	180.00	0.00	0.00	-0.35	-26.42	0.00
1.3	0.35	-36.50	29.34	0.00	0.00	0.00	0.35	26.42	0.00
1.4	0.35	36.50	29.34	180.00	0.00	0.00	0.35	-26.42	0.00
4.1	-1.05	-36.75	29.34	0.00	0.00	0.00	-1.05	26.17	0.00
4.2	-1.05	36.75	29.34	180.00	0.00	0.00	-1.05	-26.17	0.00
4.3	1.05	-36.75	29.34	0.00	0.00	0.00	1.05	26.17	0.00
4.4	1.05	36.75	29.34	180.00	0.00	0.00	1.05	-26.17	0.00
2.1	-57.15	-36.55	29.34	0.00	0.00	0.00	-57.15	26.37	0.00
2.2	-57.15	36.55	29.34	180.00	0.00	0.00	-57.15	-26.37	0.00
2.3	57.15	-36.55	29.34	0.00	0.00	0.00	57.15	26.37	0.00
2.4	57.15	36.55	29.34	180.00	0.00	0.00	57.15	-26.37	0.00
3.1	-57.85	-36.55	29.34	0.00	0.00	0.00	-57.85	26.37	0.00
3.2	-57.85	36.55	29.34	180.00	0.00	0.00	-57.85	-26.37	0.00
3.3	57.85	-36.55	29.34	0.00	0.00	0.00	57.85	26.37	0.00
3.4	57.85	36.55	29.34	180.00	0.00	0.00	57.85	-26.37	0.00
5.1	-1.75	-37.20	29.34	0.00	0.00	0.00	-1.75	25.72	0.00
5.2	-1.75	37.20	29.34	180.00	0.00	0.00	-1.75	-25.72	0.00
5.3	1.75	-37.20	29.34	0.00	0.00	0.00	1.75	25.72	0.00
5.4	1.75	37.20	29.34	180.00	0.00	0.00	1.75	-25.72	0.00
6.1	-2.25	-37.95	29.34	0.00	0.00	0.00	-2.25	24.97	0.00
6.2	-2.25	37.95	29.34	180.00	0.00	0.00	-2.25	-24.97	0.00
6.3	2.25	-37.95	29.34	0.00	0.00	0.00	2.25	24.97	0.00
6.4	2.25	37.95	29.34	180.00	0.00	0.00	2.25	-24.97	0.00
7.1	-58.50	-36.75	29.34	20.00	0.00	0.00	-80.02	22.38	0.00
7.2	-58.50	36.75	29.34	160.00	0.00	0.00	-80.02	-22.38	0.00
7.3	58.50	-36.75	29.34	340.00	0.00	0.00	80.02	22.38	0.00
7.4	58.50	36.75	29.34	200.00	0.00	0.00	80.02	-22.38	0.00
8.1	-56.50	-36.75	29.34	0.00	0.00	0.00	-56.50	26.17	0.00
8.2	-56.50	36.75	29.34	180.00	0.00	0.00	-56.50	-26.17	0.00
8.3	56.50	-36.75	29.34	0.00	0.00	0.00	56.50	26.17	0.00
8.4	56.50	36.75	29.34	180.00	0.00	0.00	56.50	-26.17	0.00
9.1	-59.10	-37.10	29.34	20.00	0.00	0.00	-80.62	22.03	0.00
9.2	-59.10	37.10	29.34	160.00	0.00	0.00	-80.62	-22.03	0.00
9.3	59.10	-37.10	29.34	340.00	0.00	0.00	80.62	22.03	0.00

4 Bandy - 750 lx

4.1 Beskrivelse, Bandy - 750 lx

4.1.1 Armaturodata/Romobjekter

9.4	59.10	37.10	29.34	200.00	0.00	0.00	80.62	-22.03	0.00
10.1	-55.85	-37.15	29.34	0.00	0.00	0.00	-55.85	25.77	0.00
10.2	-55.85	37.15	29.34	180.00	0.00	0.00	-55.85	-25.77	0.00
10.3	55.85	-37.15	29.34	0.00	0.00	0.00	55.85	25.77	0.00
10.4	55.85	37.15	29.34	180.00	0.00	0.00	55.85	-25.77	0.00
12.1	-55.30	-37.90	29.34	0.00	0.00	0.00	-55.30	25.02	0.00
12.2	-55.30	37.90	29.34	180.00	0.00	0.00	-55.30	-25.02	0.00
12.3	55.30	-37.90	29.34	0.00	0.00	0.00	55.30	25.02	0.00
12.4	55.30	37.90	29.34	180.00	0.00	0.00	55.30	-25.02	0.00
16.1	-0.35	-37.20	28.24	0.00	0.00	0.00	-0.35	23.36	0.00
16.2	-0.35	37.20	28.24	180.00	0.00	0.00	-0.35	-23.36	0.00
16.3	0.35	-37.20	28.24	0.00	0.00	0.00	0.35	23.36	0.00
16.4	0.35	37.20	28.24	180.00	0.00	0.00	0.35	-23.36	0.00
17.1	-1.05	-37.45	28.24	0.00	0.00	0.00	-1.05	23.11	0.00
17.2	-1.05	37.45	28.24	180.00	0.00	0.00	-1.05	-23.11	0.00
17.3	1.05	-37.45	28.24	0.00	0.00	0.00	1.05	23.11	0.00
17.4	1.05	37.45	28.24	180.00	0.00	0.00	1.05	-23.11	0.00
18.1	-1.55	-38.15	28.24	0.00	0.00	0.00	-1.55	22.41	0.00
18.2	-1.55	38.15	28.24	180.00	0.00	0.00	-1.55	-22.41	0.00
18.3	1.55	-38.15	28.24	0.00	0.00	0.00	1.55	22.41	0.00
18.4	1.55	38.15	28.24	180.00	0.00	0.00	1.55	-22.41	0.00

Philips Lighting BVP528 OUT T35 1xLED2590-4S/740/740 E3/D4I A55-MB

14.1	-55.05	-38.65	29.34	0.00	0.00	0.00	-55.05	8.30	0.00
14.2	-55.05	38.65	29.34	180.00	0.00	0.00	-55.05	-8.30	0.00
14.3	55.05	-38.65	29.34	0.00	0.00	0.00	55.05	8.30	0.00
14.4	55.05	38.65	29.34	180.00	0.00	0.00	55.05	-8.30	0.00
15.1	-55.05	-39.40	29.34	0.00	0.00	0.00	-55.05	7.55	0.00
15.2	-55.05	39.40	29.34	180.00	0.00	0.00	-55.05	-7.55	0.00
15.3	55.05	-39.40	29.34	0.00	0.00	0.00	55.05	7.55	0.00
15.4	55.05	39.40	29.34	180.00	0.00	0.00	55.05	-7.55	0.00

Dimmeverdier

Nr.	Phi [lm]	Phi [%]	T [K]	Rød	Farge Grønn	Blå	Hvit
Philips Lighting BVP528 OUT T35 1xLED2590-4S/740/740 E3/D4I A65-NB							
7.1	207200.00	80.00	<input type="checkbox"/>	---	1.0000	1.0000	1.0000
7.2	207200.00	80.00	<input type="checkbox"/>	---	1.0000	1.0000	1.0000
7.3	207200.00	80.00	<input type="checkbox"/>	---	1.0000	1.0000	1.0000
7.4	207200.00	80.00	<input type="checkbox"/>	---	1.0000	1.0000	1.0000
9.1	207200.00	80.00	<input type="checkbox"/>	---	1.0000	1.0000	1.0000
9.2	207200.00	80.00	<input type="checkbox"/>	---	1.0000	1.0000	1.0000
9.3	207200.00	80.00	<input type="checkbox"/>	---	1.0000	1.0000	1.0000
9.4	207200.00	80.00	<input type="checkbox"/>	---	1.0000	1.0000	1.0000

Konstruksjonsobjekt

Objekt : Marienlyst Idrettspark
Anleggsdel : Kunstisbane
Prosjektnummer : T231002A
Dato : 02.10.2023

4 Bandy - 750 lx

4.1 Beskrivelse, Bandy - 750 lx

4.1.1 Armaturodata/Romobjekter

Virtuelt beregningsfelt

Nr.	xm[m]	ym[m]	zm[m]	Lengde	Bredde	z akse	Rotasjonsvinkel	
							lengdeakse	tverrakse
Bandy - PA 100 x 60m								
m 4	-50.00	-30.00	0.00	100.00	60.00	0.00	0.00	0.00

4.1 Beskrivelse, Bandy - 750 lx

4.1.2 Planvisning

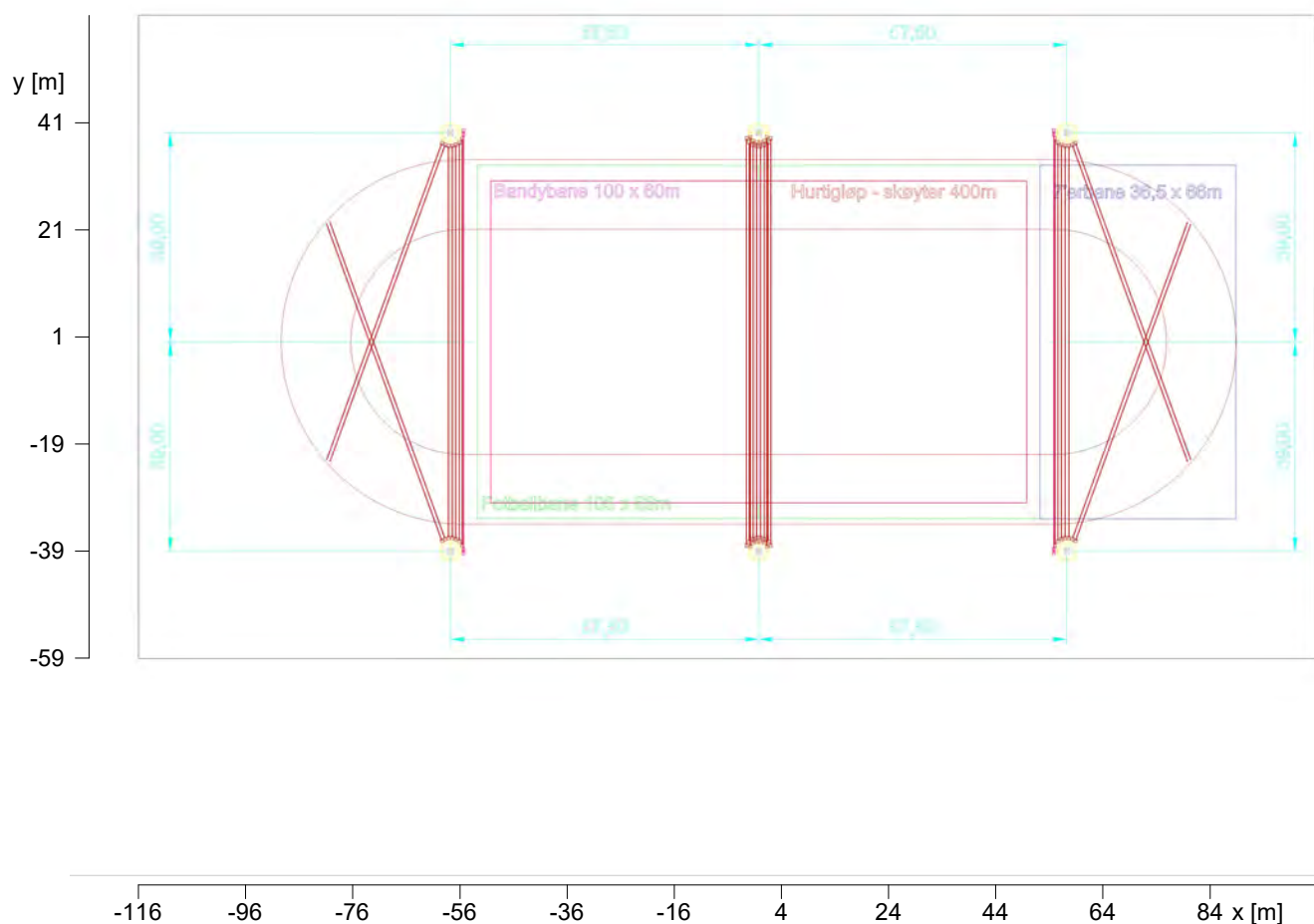

4.1 Beskrivelse, Bandy - 750 lx

4.1.3 3D visning, Vis 1

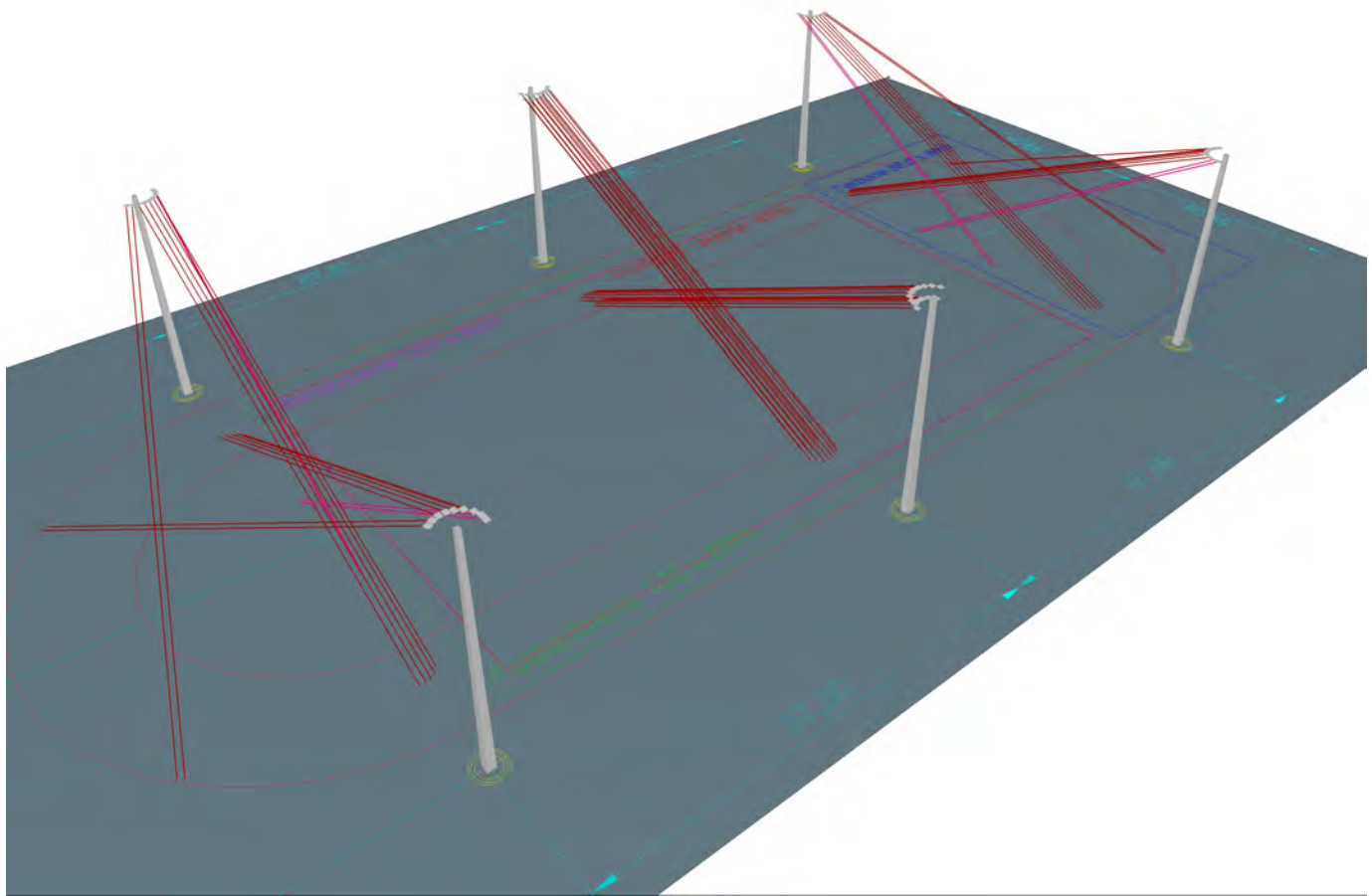

4 Bandy - 750 lx

4.2 Sammendrag, Bandy - 750 lx

4.2.1 Resultatoversikt, Bandy - PA 100 x 60m

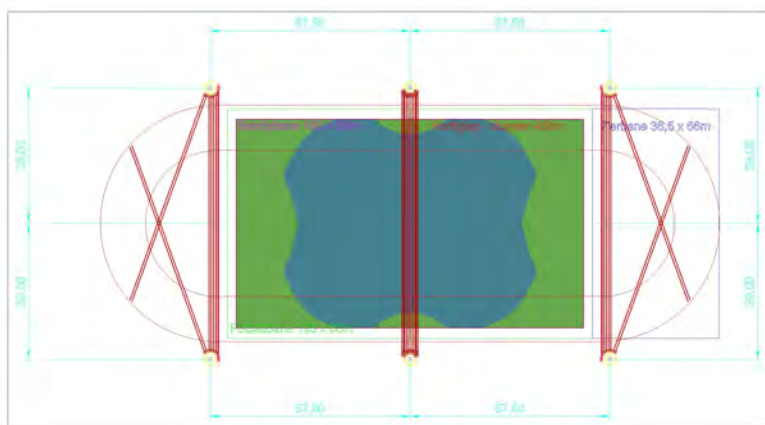

-116 -96 -76 -56 -36 -16 4 24 44 64 84 x [m]

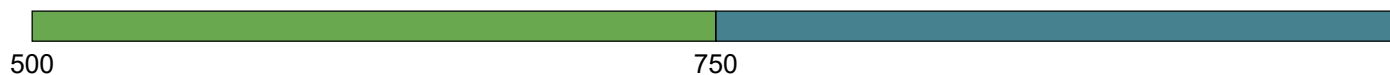

Belysningsstyrke [lx]

Generell

Anvendt beregningsalgoritme	Direkteandel
Beregningsflatens høyde	0.00 m
Vedlikeholdsfaktor	0.85

Total lysfluks 16161600 lm (97.50% dimmet)
 (Luminaires have been dimmed. For details see output page "Armaturdata/Romobjekter".)

Totaleffekt	96377.5 W
Totaleffekt per areal (26377.42 m ²)	3.65 W/m ²
Upward light ratio (ULR)	0.00

Belysningsstyrke

Gjennomsnittlig belysningsstyrke	\bar{E}_m	762 lx
Laveste belysningsstyrke	E_{min}	552 lx
Største belysningsstyrke	E_{max}	925 lx
Jevnhet U_o	E_{min}/\bar{E}_m	1:1.38 (0.72)
Jevnhet U_d	E_{min}/E_{max}	1:1.68 (0.6)

RG-Tabell

5.99 cd/m ² , 896 lx, $\rho = 60\%$ (-2°)	
$R_{G,max}$	33.3 (h=1.60m)



Type Ant.\Prod.

ULR verdiene har blitt beregnet uten påvirkning av andre objekter.

4 Bandy - 750 lx

4.2 Sammendrag, Bandy - 750 lx

4.2.1 Resultatoversikt, Bandy - PA 100 x 60m

		Philips Lighting	
1	56 x	Bestillingsnr.	:
		Armaturnavn	: BVP528 OUT T35 1xLED2590-4S/740/740 E3/D4I A65-NB
		Bestykning	: 1 x LED2590-4S/740 1505.9 W / 259000 lm
2	8 x	Bestillingsnr.	:
		Armaturnavn	: BVP528 OUT T35 1xLED2590-4S/740/740 E3/D4I A55-MB
		Bestykning	: 1 x LED2590-4S/740 1505.9 W / 259000 lm

4 Bandy - 750 lx

4.3 Beregningsresultat, Bandy - 750 lx

4.3.1 3D luminans, Vis 1

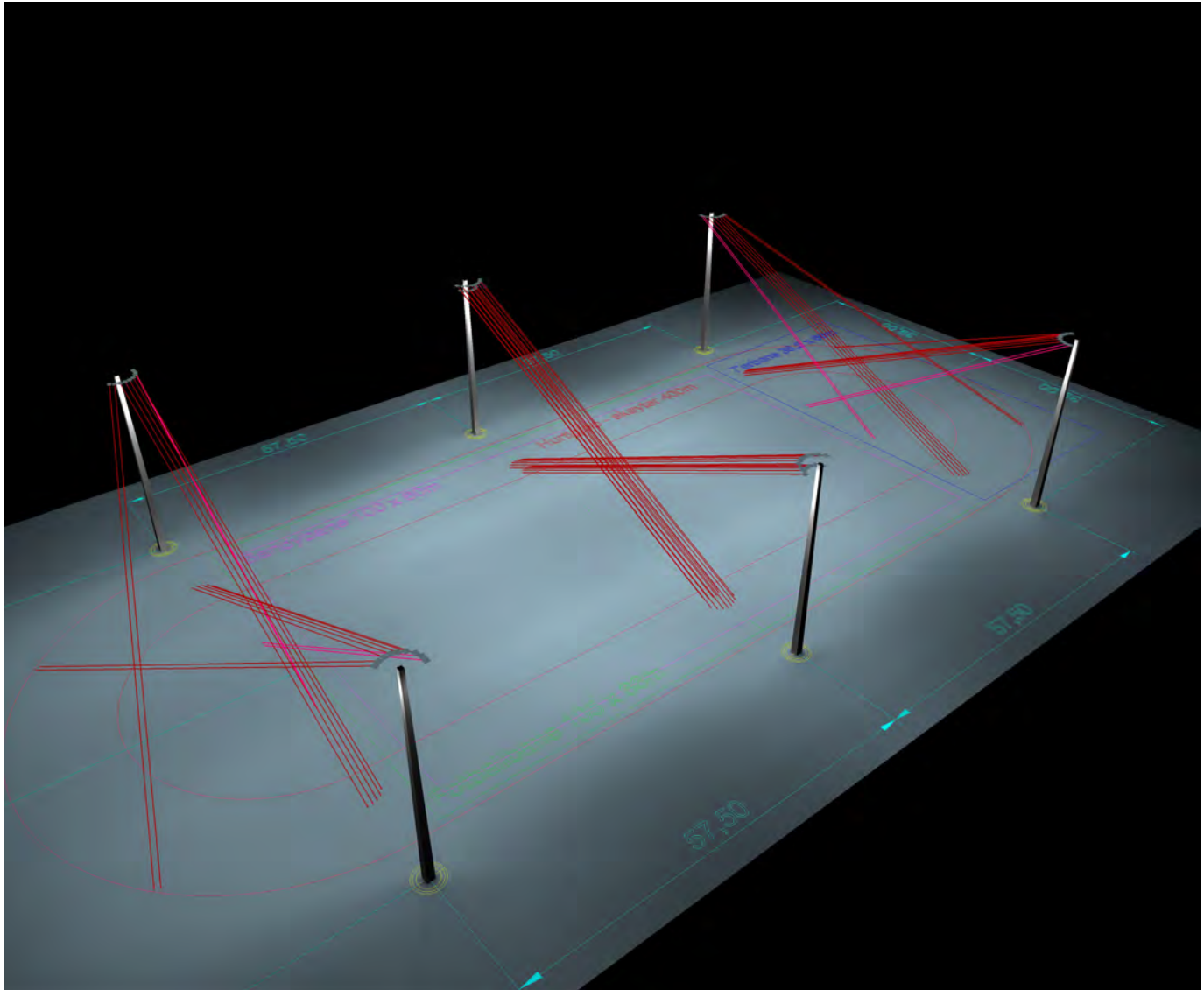

4.3 Beregningsresultat, Bandy - 750 lx

4.3.2 3D Fargeskala, Vis 1 (E)

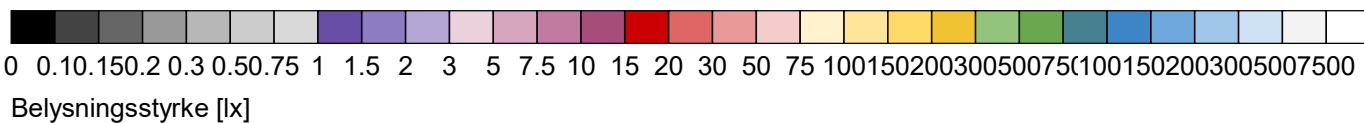
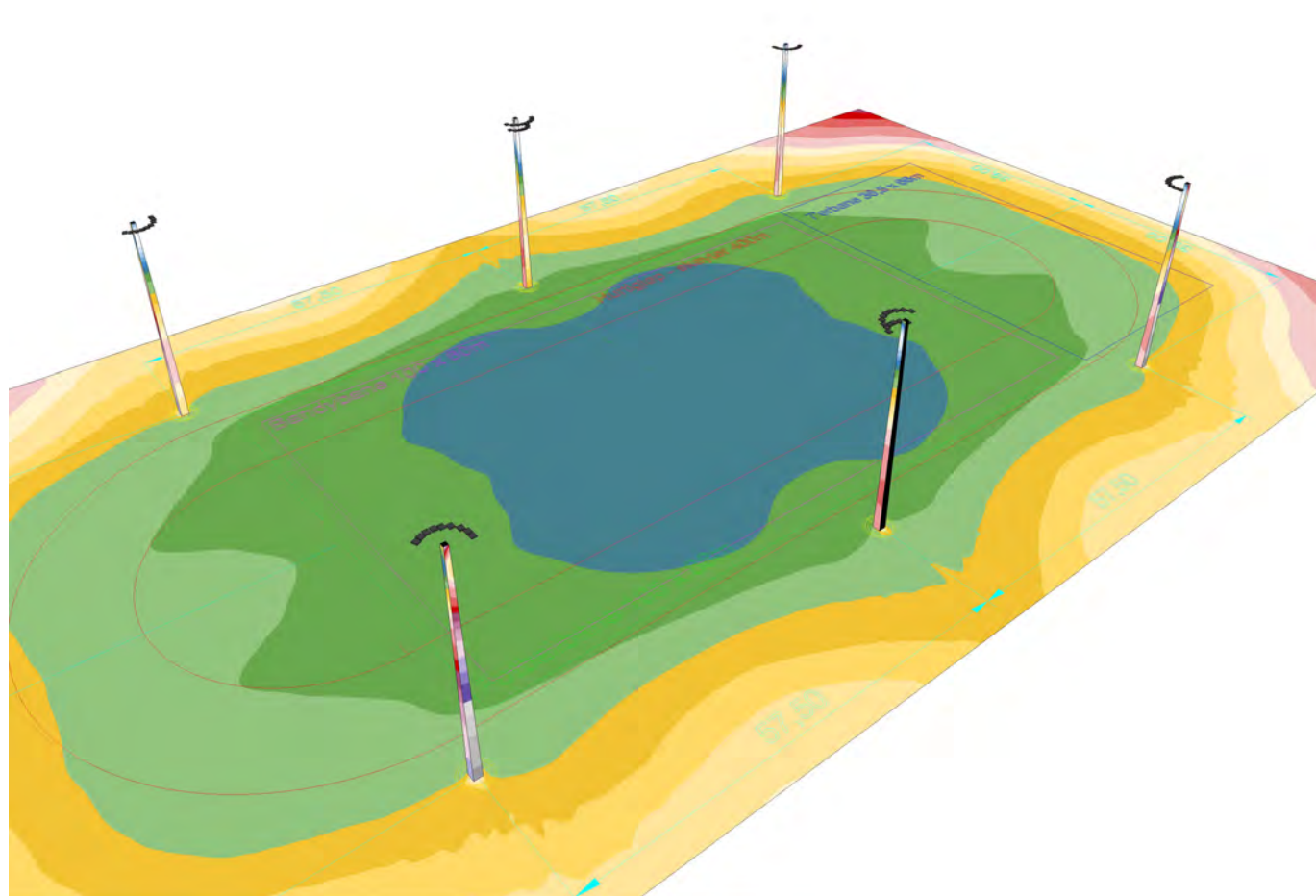



5 Fotball - 350 lx

5.1 Beskrivelse, Fotball - 350 lx

5.1.1 Armaturdata/Romobjekter

Produktspesifikasjoner:

Type Ant.\Prod.

		Philips Lighting	
1	56 x	Bestillingsnr.	:
		Armaturnavn	: BVP528 OUT T35 1xLED2590-4S/740/740 E3/D4I A65-NB
		Bestykning	: 1 x LED2590-4S/740 1505.9 W / 259000 lm
2	8 x	Bestillingsnr.	:
		Armaturnavn	: BVP528 OUT T35 1xLED2590-4S/740/740 E3/D4I A55-MB
		Bestykning	: 1 x LED2590-4S/740 1505.9 W / 259000 lm

Nr.	Midtpunkt			Rotasjonsvinkel			Orienteringspunktkoordinater		
	X [m]	Y [m]	Z [m]	Z [°]	C0 [°]	C90 [°]	Xa [m]	Ya [m]	Za [m]
Philips Lighting BVP528 OUT T35 1xLED2590-4S/740/740 E3/D4I A65-NB									
1.1	-0.35	-36.50	29.34	0.00	0.00	0.00	-0.35	26.42	0.00
1.2	-0.35	36.50	29.34	180.00	0.00	0.00	-0.35	-26.42	0.00
1.3	0.35	-36.50	29.34	0.00	0.00	0.00	0.35	26.42	0.00
1.4	0.35	36.50	29.34	180.00	0.00	0.00	0.35	-26.42	0.00
4.1	-1.05	-36.75	29.34	0.00	0.00	0.00	-1.05	26.17	0.00
4.2	-1.05	36.75	29.34	180.00	0.00	0.00	-1.05	-26.17	0.00
4.3	1.05	-36.75	29.34	0.00	0.00	0.00	1.05	26.17	0.00
4.4	1.05	36.75	29.34	180.00	0.00	0.00	1.05	-26.17	0.00
2.1	-57.15	-36.55	29.34	0.00	0.00	0.00	-57.15	26.37	0.00
2.2	-57.15	36.55	29.34	180.00	0.00	0.00	-57.15	-26.37	0.00
2.3	57.15	-36.55	29.34	0.00	0.00	0.00	57.15	26.37	0.00
2.4	57.15	36.55	29.34	180.00	0.00	0.00	57.15	-26.37	0.00
X 3.1	-57.85	-36.55	29.34	0.00	0.00	0.00	-57.85	26.37	0.00
X 3.2	-57.85	36.55	29.34	180.00	0.00	0.00	-57.85	-26.37	0.00
X 3.3	57.85	-36.55	29.34	0.00	0.00	0.00	57.85	26.37	0.00
X 3.4	57.85	36.55	29.34	180.00	0.00	0.00	57.85	-26.37	0.00
5.1	-1.75	-37.20	29.34	0.00	0.00	0.00	-1.75	25.72	0.00
5.2	-1.75	37.20	29.34	180.00	0.00	0.00	-1.75	-25.72	0.00
5.3	1.75	-37.20	29.34	0.00	0.00	0.00	1.75	25.72	0.00
5.4	1.75	37.20	29.34	180.00	0.00	0.00	1.75	-25.72	0.00
6.1	-2.25	-37.95	29.34	0.00	0.00	0.00	-2.25	24.97	0.00
6.2	-2.25	37.95	29.34	180.00	0.00	0.00	-2.25	-24.97	0.00
6.3	2.25	-37.95	29.34	0.00	0.00	0.00	2.25	24.97	0.00
6.4	2.25	37.95	29.34	180.00	0.00	0.00	2.25	-24.97	0.00
X 7.1	-58.50	-36.75	29.34	20.00	0.00	0.00	-80.02	22.38	0.00
X 7.2	-58.50	36.75	29.34	160.00	0.00	0.00	-80.02	-22.38	0.00
X 7.3	58.50	-36.75	29.34	340.00	0.00	0.00	80.02	22.38	0.00
X 7.4	58.50	36.75	29.34	200.00	0.00	0.00	80.02	-22.38	0.00
8.1	-56.50	-36.75	29.34	0.00	0.00	0.00	-56.50	26.17	0.00
8.2	-56.50	36.75	29.34	180.00	0.00	0.00	-56.50	-26.17	0.00
8.3	56.50	-36.75	29.34	0.00	0.00	0.00	56.50	26.17	0.00
8.4	56.50	36.75	29.34	180.00	0.00	0.00	56.50	-26.17	0.00
X 9.1	-59.10	-37.10	29.34	20.00	0.00	0.00	-80.62	22.03	0.00
X 9.2	-59.10	37.10	29.34	160.00	0.00	0.00	-80.62	-22.03	0.00
X 9.3	59.10	-37.10	29.34	340.00	0.00	0.00	80.62	22.03	0.00

5 Fotball - 350 lx

5.1 Beskrivelse, Fotball - 350 lx

5.1.1 Armaturodata/Romobjekter

X 9.4	59.10	37.10	29.34	200.00	0.00	0.00	80.62	-22.03	0.00
10.1	-55.85	-37.15	29.34	0.00	0.00	0.00	-55.85	25.77	0.00
10.2	-55.85	37.15	29.34	180.00	0.00	0.00	-55.85	-25.77	0.00
10.3	55.85	-37.15	29.34	0.00	0.00	0.00	55.85	25.77	0.00
10.4	55.85	37.15	29.34	180.00	0.00	0.00	55.85	-25.77	0.00
12.1	-55.30	-37.90	29.34	0.00	0.00	0.00	-55.30	25.02	0.00
12.2	-55.30	37.90	29.34	180.00	0.00	0.00	-55.30	-25.02	0.00
12.3	55.30	-37.90	29.34	0.00	0.00	0.00	55.30	25.02	0.00
12.4	55.30	37.90	29.34	180.00	0.00	0.00	55.30	-25.02	0.00
16.1	-0.35	-37.20	28.24	0.00	0.00	0.00	-0.35	23.36	0.00
16.2	-0.35	37.20	28.24	180.00	0.00	0.00	-0.35	-23.36	0.00
16.3	0.35	-37.20	28.24	0.00	0.00	0.00	0.35	23.36	0.00
16.4	0.35	37.20	28.24	180.00	0.00	0.00	0.35	-23.36	0.00
17.1	-1.05	-37.45	28.24	0.00	0.00	0.00	-1.05	23.11	0.00
17.2	-1.05	37.45	28.24	180.00	0.00	0.00	-1.05	-23.11	0.00
17.3	1.05	-37.45	28.24	0.00	0.00	0.00	1.05	23.11	0.00
17.4	1.05	37.45	28.24	180.00	0.00	0.00	1.05	-23.11	0.00
18.1	-1.55	-38.15	28.24	0.00	0.00	0.00	-1.55	22.41	0.00
18.2	-1.55	38.15	28.24	180.00	0.00	0.00	-1.55	-22.41	0.00
18.3	1.55	-38.15	28.24	0.00	0.00	0.00	1.55	22.41	0.00
18.4	1.55	38.15	28.24	180.00	0.00	0.00	1.55	-22.41	0.00

Philips Lighting BVP528 OUT T35 1xLED2590-4S/740/740 E3/D4I A55-MB

14.1	-55.05	-38.65	29.34	0.00	0.00	0.00	-55.05	8.30	0.00
14.2	-55.05	38.65	29.34	180.00	0.00	0.00	-55.05	-8.30	0.00
14.3	55.05	-38.65	29.34	0.00	0.00	0.00	55.05	8.30	0.00
14.4	55.05	38.65	29.34	180.00	0.00	0.00	55.05	-8.30	0.00
15.1	-55.05	-39.40	29.34	0.00	0.00	0.00	-55.05	7.55	0.00
15.2	-55.05	39.40	29.34	180.00	0.00	0.00	-55.05	-7.55	0.00
15.3	55.05	-39.40	29.34	0.00	0.00	0.00	55.05	7.55	0.00
15.4	55.05	39.40	29.34	180.00	0.00	0.00	55.05	-7.55	0.00

Dimmeverdier

Nr.	Phi [lm]	Phi [%]		T [K]	Rød	Farge Grønn	Blå	Hvit
Philips Lighting BVP528 OUT T35 1xLED2590-4S/740/740 E3/D4I A65-NB								
1.1	103600.00	40.00	<input type="checkbox"/>	---	1.0000	1.0000	1.0000	---
1.2	103600.00	40.00	<input type="checkbox"/>	---	1.0000	1.0000	1.0000	---
1.3	103600.00	40.00	<input type="checkbox"/>	---	1.0000	1.0000	1.0000	---
1.4	103600.00	40.00	<input type="checkbox"/>	---	1.0000	1.0000	1.0000	---
4.1	103600.00	40.00	<input type="checkbox"/>	---	1.0000	1.0000	1.0000	---
4.2	103600.00	40.00	<input type="checkbox"/>	---	1.0000	1.0000	1.0000	---
4.3	103600.00	40.00	<input type="checkbox"/>	---	1.0000	1.0000	1.0000	---
4.4	103600.00	40.00	<input type="checkbox"/>	---	1.0000	1.0000	1.0000	---
2.1	233100.00	90.00	<input type="checkbox"/>	---	1.0000	1.0000	1.0000	---
2.2	233100.00	90.00	<input type="checkbox"/>	---	1.0000	1.0000	1.0000	---
2.3	233100.00	90.00	<input type="checkbox"/>	---	1.0000	1.0000	1.0000	---
2.4	233100.00	90.00	<input type="checkbox"/>	---	1.0000	1.0000	1.0000	---
5.1	103600.00	40.00	<input type="checkbox"/>	---	1.0000	1.0000	1.0000	---

5 Fotball - 350 lx

5.1 Beskrivelse, Fotball - 350 lx

5.1.1 Armaturdata/Romobjekter

5.2	103600.00	40.00	<input type="checkbox"/>	---	1.0000	1.0000	1.0000	---
5.3	103600.00	40.00	<input type="checkbox"/>	---	1.0000	1.0000	1.0000	---
5.4	103600.00	40.00	<input type="checkbox"/>	---	1.0000	1.0000	1.0000	---
6.1	103600.00	40.00	<input type="checkbox"/>	---	1.0000	1.0000	1.0000	---
6.2	103600.00	40.00	<input type="checkbox"/>	---	1.0000	1.0000	1.0000	---
6.3	103600.00	40.00	<input type="checkbox"/>	---	1.0000	1.0000	1.0000	---
6.4	103600.00	40.00	<input type="checkbox"/>	---	1.0000	1.0000	1.0000	---
8.1	233100.00	90.00	<input type="checkbox"/>	---	1.0000	1.0000	1.0000	---
8.2	233100.00	90.00	<input type="checkbox"/>	---	1.0000	1.0000	1.0000	---
8.3	233100.00	90.00	<input type="checkbox"/>	---	1.0000	1.0000	1.0000	---
8.4	233100.00	90.00	<input type="checkbox"/>	---	1.0000	1.0000	1.0000	---
10.1	233100.00	90.00	<input type="checkbox"/>	---	1.0000	1.0000	1.0000	---
10.2	233100.00	90.00	<input type="checkbox"/>	---	1.0000	1.0000	1.0000	---
10.3	233100.00	90.00	<input type="checkbox"/>	---	1.0000	1.0000	1.0000	---
10.4	233100.00	90.00	<input type="checkbox"/>	---	1.0000	1.0000	1.0000	---
12.1	233100.00	90.00	<input type="checkbox"/>	---	1.0000	1.0000	1.0000	---
12.2	233100.00	90.00	<input type="checkbox"/>	---	1.0000	1.0000	1.0000	---
12.3	233100.00	90.00	<input type="checkbox"/>	---	1.0000	1.0000	1.0000	---
12.4	233100.00	90.00	<input type="checkbox"/>	---	1.0000	1.0000	1.0000	---
16.1	103600.00	40.00	<input type="checkbox"/>	---	1.0000	1.0000	1.0000	---
16.2	103600.00	40.00	<input type="checkbox"/>	---	1.0000	1.0000	1.0000	---
16.3	103600.00	40.00	<input type="checkbox"/>	---	1.0000	1.0000	1.0000	---
16.4	103600.00	40.00	<input type="checkbox"/>	---	1.0000	1.0000	1.0000	---
17.1	103600.00	40.00	<input type="checkbox"/>	---	1.0000	1.0000	1.0000	---
17.2	103600.00	40.00	<input type="checkbox"/>	---	1.0000	1.0000	1.0000	---
17.3	103600.00	40.00	<input type="checkbox"/>	---	1.0000	1.0000	1.0000	---
17.4	103600.00	40.00	<input type="checkbox"/>	---	1.0000	1.0000	1.0000	---
18.1	103600.00	40.00	<input type="checkbox"/>	---	1.0000	1.0000	1.0000	---
18.2	103600.00	40.00	<input type="checkbox"/>	---	1.0000	1.0000	1.0000	---
18.3	103600.00	40.00	<input type="checkbox"/>	---	1.0000	1.0000	1.0000	---
18.4	103600.00	40.00	<input type="checkbox"/>	---	1.0000	1.0000	1.0000	---

Philips Lighting BVP528 OUT T35 1xLED2590-4S/740/740 E3/D4I A55-MB

14.1	233100.00	90.00	<input type="checkbox"/>	---	1.0000	1.0000	1.0000	---
14.2	233100.00	90.00	<input type="checkbox"/>	---	1.0000	1.0000	1.0000	---
14.3	233100.00	90.00	<input type="checkbox"/>	---	1.0000	1.0000	1.0000	---
14.4	233100.00	90.00	<input type="checkbox"/>	---	1.0000	1.0000	1.0000	---
15.1	233100.00	90.00	<input type="checkbox"/>	---	1.0000	1.0000	1.0000	---
15.2	233100.00	90.00	<input type="checkbox"/>	---	1.0000	1.0000	1.0000	---
15.3	233100.00	90.00	<input type="checkbox"/>	---	1.0000	1.0000	1.0000	---
15.4	233100.00	90.00	<input type="checkbox"/>	---	1.0000	1.0000	1.0000	---

X : Off for general artificial light

Konstruksjonsobjekt

Virtuelt beregningsfelt

Nr.	xm[m]	ym[m]	zm[m]	Lengde	Bredde	Rotasjonsvinkel		
						z akse	lengdeakse	tverrakse
Fotball PA 105 x 66m								
m 3	0.00	0.00	0.00	105.00	66.00	0.00	0.00	0.00

5.1 Beskrivelse, Fotball - 350 lx

5.1.2 Planvisning

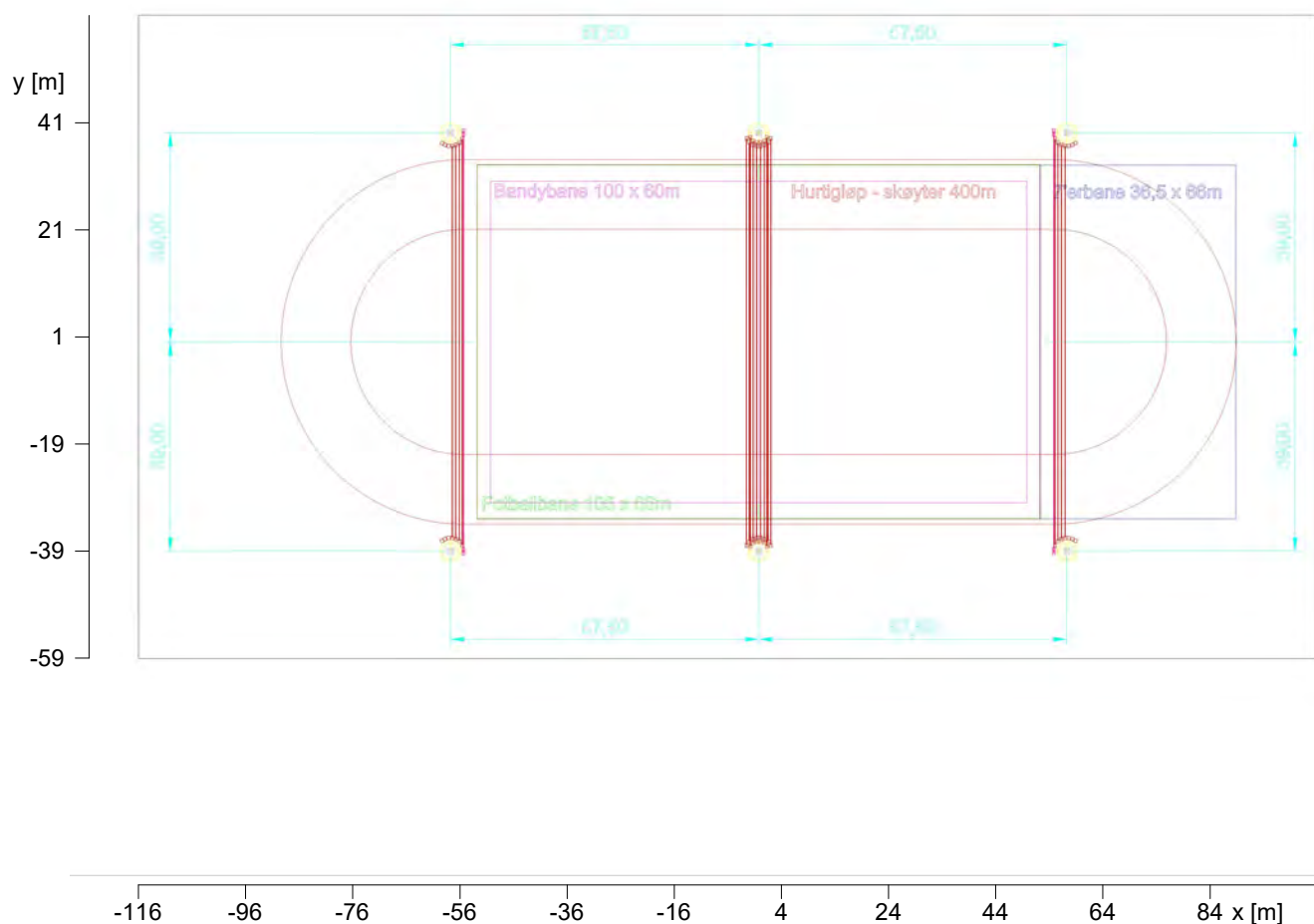

5.1 Beskrivelse, Fotball - 350 lx

5.1.3 3D visning, Vis 1

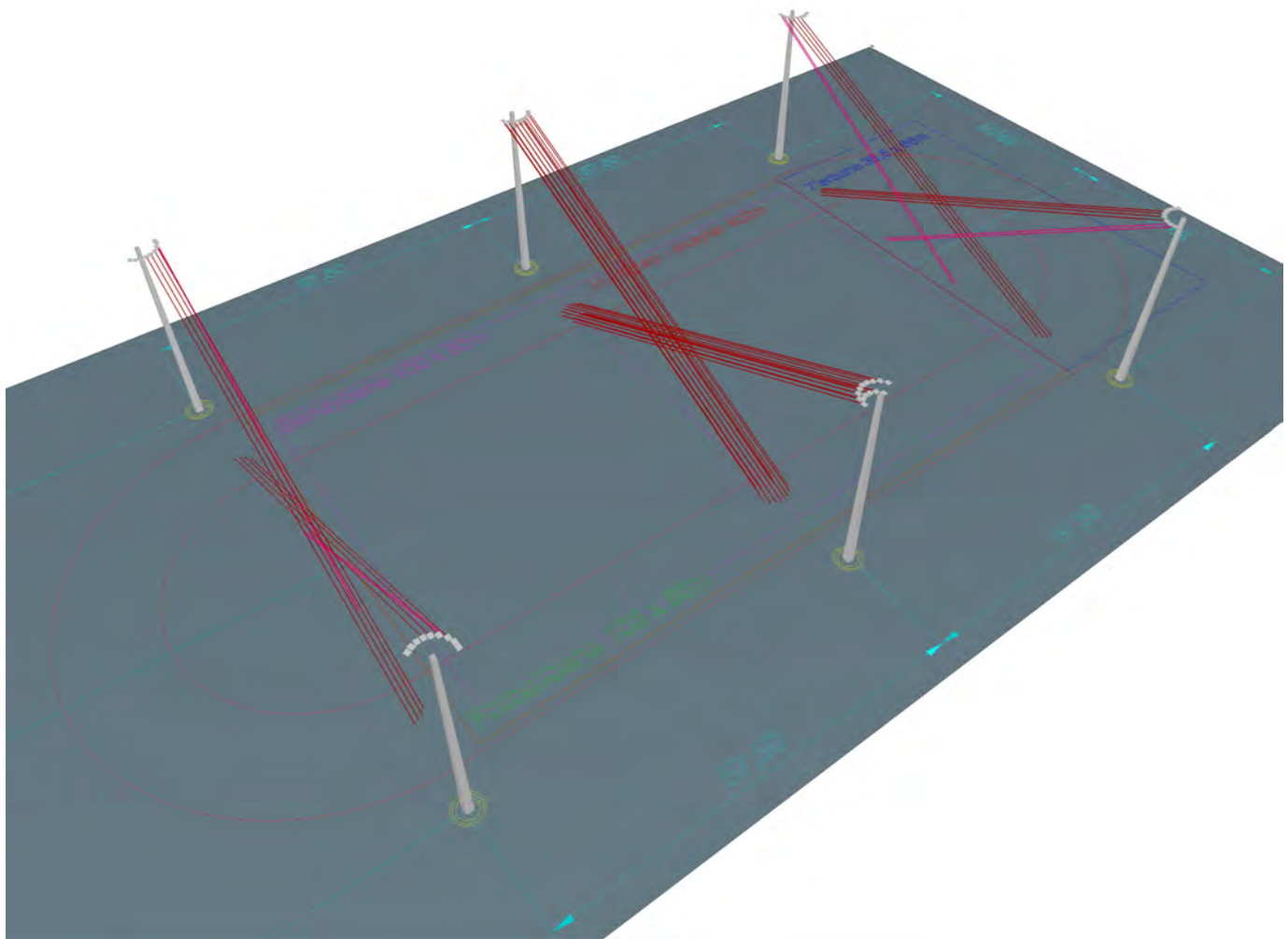

5 Fotball - 350 lx

5.2 Sammendrag, Fotball - 350 lx

5.2.1 Resultatoversikt, Fotball PA 105 x 66m

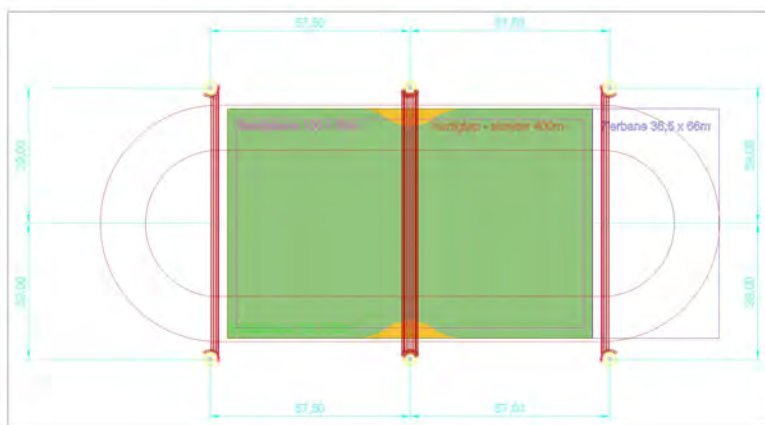

-116 -96 -76 -56 -36 -16 4 24 44 64 84 x [m]

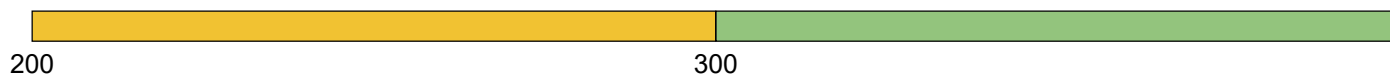

Belysningsstyrke [lx]

Generell

Anvendt beregningsalgoritme	Direkteandel
Beregningsflatens høyde	0.00 m
Vedlikeholdsfaktor	0.85

Total lysfluks 8495200 lm (63.08% dimmet)
 (Luminaires have been dimmed. For details see output page "Armaturdata/Romobjekter".)

Totaleffekt	78306.8 W
Totaleffekt per areal (26377.42 m ²)	2.97 W/m ²
Upward light ratio (ULR)	0.00

Belysningsstyrke

Gjennomsnittlig belysningsstyrke	\bar{E}_m	370 lx
Laveste belysningsstyrke	E_{min}	283 lx
Største belysningsstyrke	E_{max}	443 lx
Jevnhet U_o	E_{min}/\bar{E}_m	1:1.31 (0.77)
Jevnhet U_d	E_{min}/E_{max}	1:1.56 (0.64)

RG-Tabell

0.73 cd/m², 435 lx, $\rho = 15\%$ (-2°)



$R_{G,max}$ 43.8 (h=1.60m)

Type Ant.\Prod.

5 Fotball - 350 lx

5.2 Sammendrag, Fotball - 350 lx

5.2.1 Resultatoversikt, Fotball PA 105 x 66m

		Philips Lighting	
1	44 x	Bestillingsnr.	:
		Armaturnavn	: BVP528 OUT T35 1xLED2590-4S/740/740 E3/D4I A65-NB
		Bestykning	: 1 x LED2590-4S/740 1505.9 W / 259000 lm
2	8 x	Bestillingsnr.	:
		Armaturnavn	: BVP528 OUT T35 1xLED2590-4S/740/740 E3/D4I A55-MB
		Bestykning	: 1 x LED2590-4S/740 1505.9 W / 259000 lm

5 Fotball - 350 lx

5.3 Beregningsresultat, Fotball - 350 lx

5.3.1 3D luminans, Vis 1

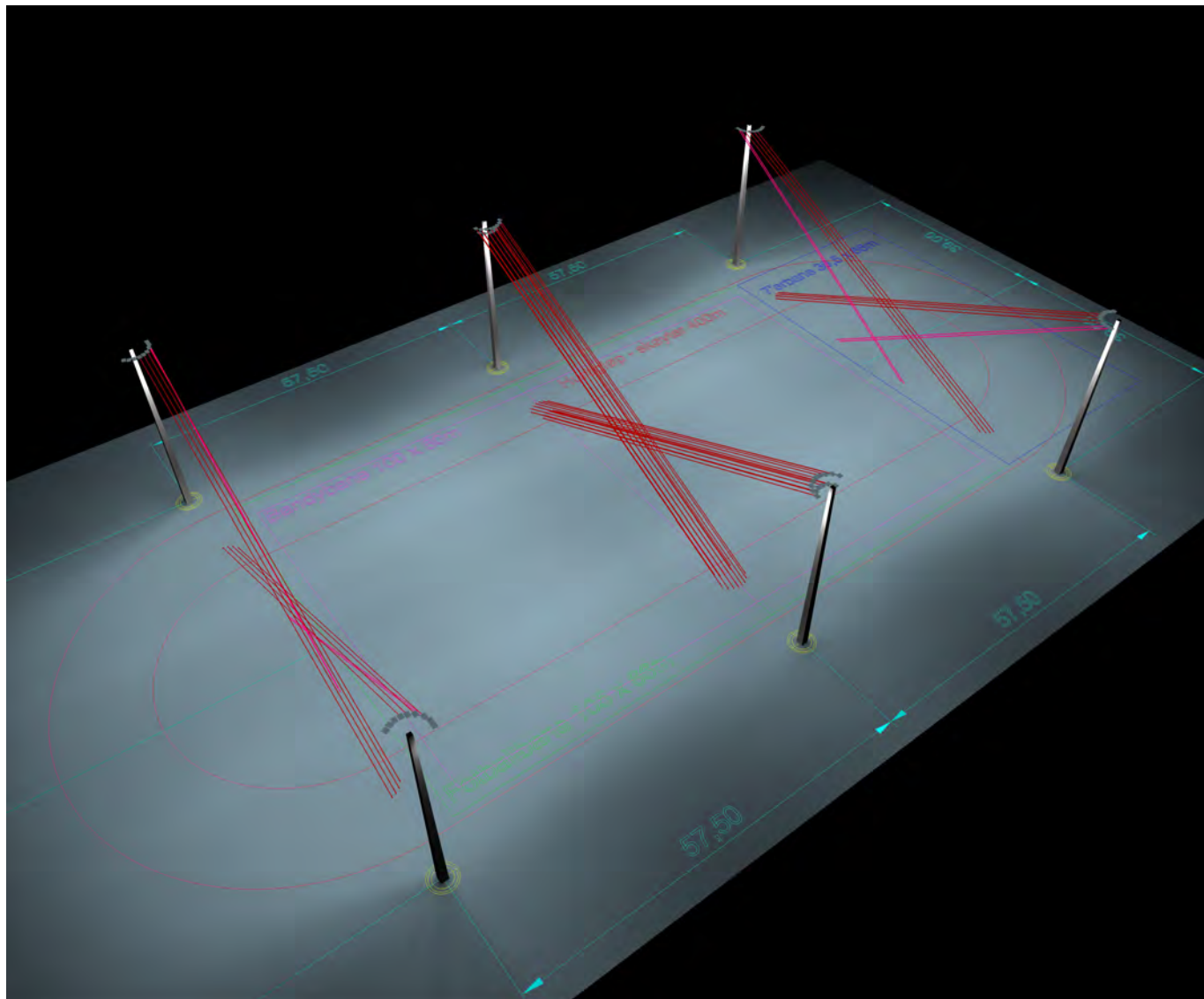

5.3 Beregningsresultat, Fotball - 350 lx

5.3.2 3D Fargeskala, Vis 1 (E)

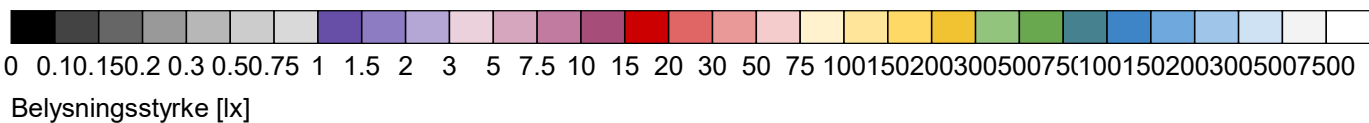
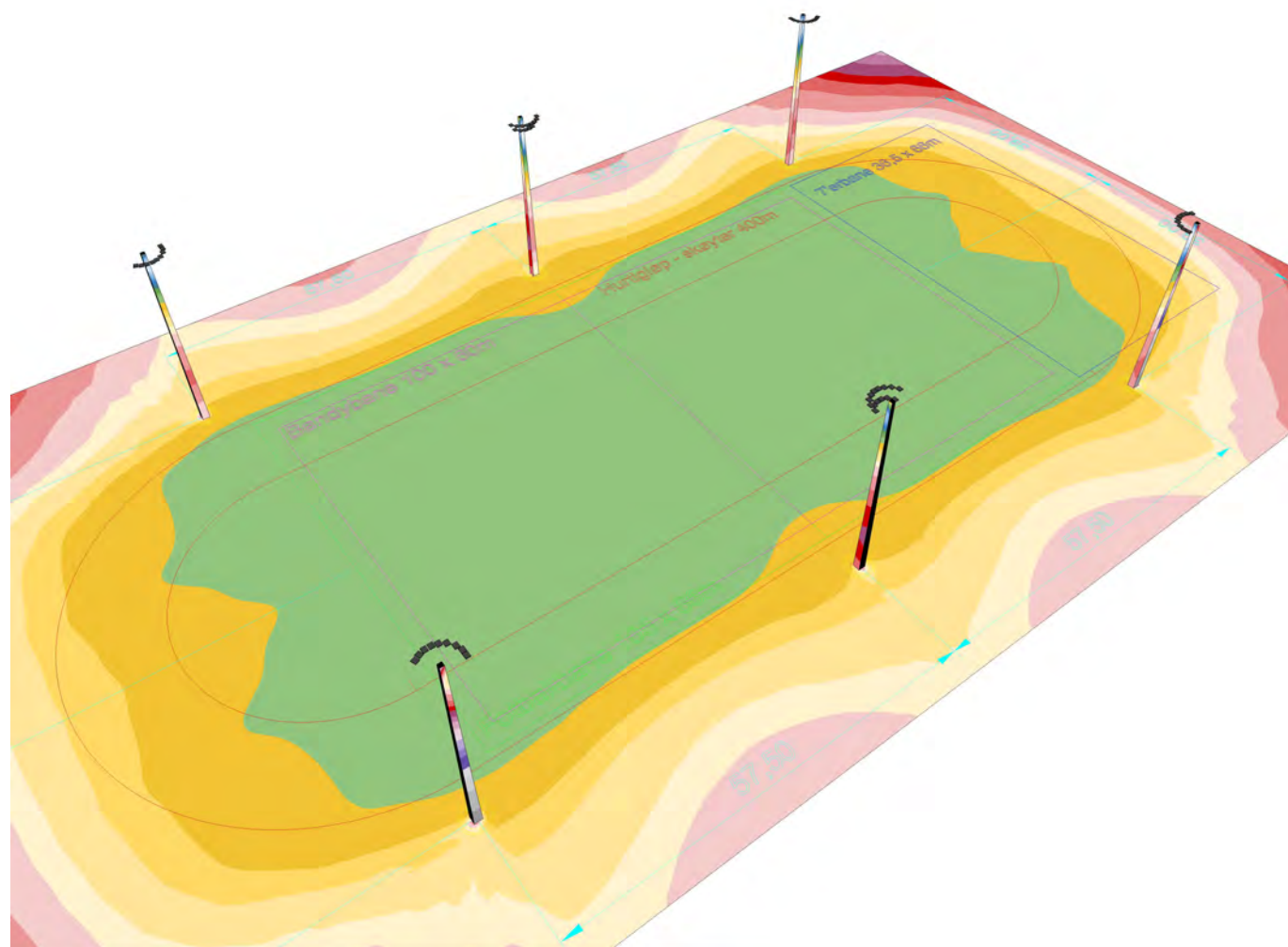



6 Fotball - 200 lx

6.1 Beskrivelse, Fotball - 200 lx

6.1.1 Armaturdata/Romobjekter

Produktspesifikasjoner:

Type Ant.\Prod.

		Philips Lighting	
1	56 x	Bestillingsnr.	:
		Armaturnavn	: BVP528 OUT T35 1xLED2590-4S/740/740 E3/D4I A65-NB
		Bestykning	: 1 x LED2590-4S/740 1505.9 W / 259000 lm
2	8 x	Bestillingsnr.	:
		Armaturnavn	: BVP528 OUT T35 1xLED2590-4S/740/740 E3/D4I A55-MB
		Bestykning	: 1 x LED2590-4S/740 1505.9 W / 259000 lm

Nr.	Midtpunkt			Rotasjonsvinkel			Orienteringspunktkoordinater		
	X [m]	Y [m]	Z [m]	Z [°]	C0 [°]	C90 [°]	Xa [m]	Ya [m]	Za [m]
Philips Lighting BVP528 OUT T35 1xLED2590-4S/740/740 E3/D4I A65-NB									
1.1	-0.35	-36.50	29.34	0.00	0.00	0.00	-0.35	26.42	0.00
1.2	-0.35	36.50	29.34	180.00	0.00	0.00	-0.35	-26.42	0.00
1.3	0.35	-36.50	29.34	0.00	0.00	0.00	0.35	26.42	0.00
1.4	0.35	36.50	29.34	180.00	0.00	0.00	0.35	-26.42	0.00
4.1	-1.05	-36.75	29.34	0.00	0.00	0.00	-1.05	26.17	0.00
4.2	-1.05	36.75	29.34	180.00	0.00	0.00	-1.05	-26.17	0.00
4.3	1.05	-36.75	29.34	0.00	0.00	0.00	1.05	26.17	0.00
4.4	1.05	36.75	29.34	180.00	0.00	0.00	1.05	-26.17	0.00
2.1	-57.15	-36.55	29.34	0.00	0.00	0.00	-57.15	26.37	0.00
2.2	-57.15	36.55	29.34	180.00	0.00	0.00	-57.15	-26.37	0.00
2.3	57.15	-36.55	29.34	0.00	0.00	0.00	57.15	26.37	0.00
2.4	57.15	36.55	29.34	180.00	0.00	0.00	57.15	-26.37	0.00
X 3.1	-57.85	-36.55	29.34	0.00	0.00	0.00	-57.85	26.37	0.00
X 3.2	-57.85	36.55	29.34	180.00	0.00	0.00	-57.85	-26.37	0.00
X 3.3	57.85	-36.55	29.34	0.00	0.00	0.00	57.85	26.37	0.00
X 3.4	57.85	36.55	29.34	180.00	0.00	0.00	57.85	-26.37	0.00
5.1	-1.75	-37.20	29.34	0.00	0.00	0.00	-1.75	25.72	0.00
5.2	-1.75	37.20	29.34	180.00	0.00	0.00	-1.75	-25.72	0.00
5.3	1.75	-37.20	29.34	0.00	0.00	0.00	1.75	25.72	0.00
5.4	1.75	37.20	29.34	180.00	0.00	0.00	1.75	-25.72	0.00
6.1	-2.25	-37.95	29.34	0.00	0.00	0.00	-2.25	24.97	0.00
6.2	-2.25	37.95	29.34	180.00	0.00	0.00	-2.25	-24.97	0.00
6.3	2.25	-37.95	29.34	0.00	0.00	0.00	2.25	24.97	0.00
6.4	2.25	37.95	29.34	180.00	0.00	0.00	2.25	-24.97	0.00
X 7.1	-58.50	-36.75	29.34	20.00	0.00	0.00	-80.02	22.38	0.00
X 7.2	-58.50	36.75	29.34	160.00	0.00	0.00	-80.02	-22.38	0.00
X 7.3	58.50	-36.75	29.34	340.00	0.00	0.00	80.02	22.38	0.00
X 7.4	58.50	36.75	29.34	200.00	0.00	0.00	80.02	-22.38	0.00
8.1	-56.50	-36.75	29.34	0.00	0.00	0.00	-56.50	26.17	0.00
8.2	-56.50	36.75	29.34	180.00	0.00	0.00	-56.50	-26.17	0.00
8.3	56.50	-36.75	29.34	0.00	0.00	0.00	56.50	26.17	0.00
8.4	56.50	36.75	29.34	180.00	0.00	0.00	56.50	-26.17	0.00
X 9.1	-59.10	-37.10	29.34	20.00	0.00	0.00	-80.62	22.03	0.00
X 9.2	-59.10	37.10	29.34	160.00	0.00	0.00	-80.62	-22.03	0.00
X 9.3	59.10	-37.10	29.34	340.00	0.00	0.00	80.62	22.03	0.00

6 Fotball - 200 lx

6.1 Beskrivelse, Fotball - 200 lx

6.1.1 Armaturodata/Romobjekter

X 9.4	59.10	37.10	29.34	200.00	0.00	0.00	80.62	-22.03	0.00
10.1	-55.85	-37.15	29.34	0.00	0.00	0.00	-55.85	25.77	0.00
10.2	-55.85	37.15	29.34	180.00	0.00	0.00	-55.85	-25.77	0.00
10.3	55.85	-37.15	29.34	0.00	0.00	0.00	55.85	25.77	0.00
10.4	55.85	37.15	29.34	180.00	0.00	0.00	55.85	-25.77	0.00
12.1	-55.30	-37.90	29.34	0.00	0.00	0.00	-55.30	25.02	0.00
12.2	-55.30	37.90	29.34	180.00	0.00	0.00	-55.30	-25.02	0.00
12.3	55.30	-37.90	29.34	0.00	0.00	0.00	55.30	25.02	0.00
12.4	55.30	37.90	29.34	180.00	0.00	0.00	55.30	-25.02	0.00
16.1	-0.35	-37.20	28.24	0.00	0.00	0.00	-0.35	23.36	0.00
16.2	-0.35	37.20	28.24	180.00	0.00	0.00	-0.35	-23.36	0.00
16.3	0.35	-37.20	28.24	0.00	0.00	0.00	0.35	23.36	0.00
16.4	0.35	37.20	28.24	180.00	0.00	0.00	0.35	-23.36	0.00
17.1	-1.05	-37.45	28.24	0.00	0.00	0.00	-1.05	23.11	0.00
17.2	-1.05	37.45	28.24	180.00	0.00	0.00	-1.05	-23.11	0.00
17.3	1.05	-37.45	28.24	0.00	0.00	0.00	1.05	23.11	0.00
17.4	1.05	37.45	28.24	180.00	0.00	0.00	1.05	-23.11	0.00
18.1	-1.55	-38.15	28.24	0.00	0.00	0.00	-1.55	22.41	0.00
18.2	-1.55	38.15	28.24	180.00	0.00	0.00	-1.55	-22.41	0.00
18.3	1.55	-38.15	28.24	0.00	0.00	0.00	1.55	22.41	0.00
18.4	1.55	38.15	28.24	180.00	0.00	0.00	1.55	-22.41	0.00

Philips Lighting BVP528 OUT T35 1xLED2590-4S/740/740 E3/D4I A55-MB

14.1	-55.05	-38.65	29.34	0.00	0.00	0.00	-55.05	8.30	0.00
14.2	-55.05	38.65	29.34	180.00	0.00	0.00	-55.05	-8.30	0.00
14.3	55.05	-38.65	29.34	0.00	0.00	0.00	55.05	8.30	0.00
14.4	55.05	38.65	29.34	180.00	0.00	0.00	55.05	-8.30	0.00
15.1	-55.05	-39.40	29.34	0.00	0.00	0.00	-55.05	7.55	0.00
15.2	-55.05	39.40	29.34	180.00	0.00	0.00	-55.05	-7.55	0.00
15.3	55.05	-39.40	29.34	0.00	0.00	0.00	55.05	7.55	0.00
15.4	55.05	39.40	29.34	180.00	0.00	0.00	55.05	-7.55	0.00

Dimmeverdier

Nr.	Phi [lm]	Phi [%]		T [K]	Rød	Farge Grønn	Blå	Hvit
Philips Lighting BVP528 OUT T35 1xLED2590-4S/740/740 E3/D4I A65-NB								
1.1	64750.00	25.00	<input type="checkbox"/>	---	1.0000	1.0000	1.0000	---
1.2	64750.00	25.00	<input type="checkbox"/>	---	1.0000	1.0000	1.0000	---
1.3	64750.00	25.00	<input type="checkbox"/>	---	1.0000	1.0000	1.0000	---
1.4	64750.00	25.00	<input type="checkbox"/>	---	1.0000	1.0000	1.0000	---
4.1	64750.00	25.00	<input type="checkbox"/>	---	1.0000	1.0000	1.0000	---
4.2	64750.00	25.00	<input type="checkbox"/>	---	1.0000	1.0000	1.0000	---
4.3	64750.00	25.00	<input type="checkbox"/>	---	1.0000	1.0000	1.0000	---
4.4	64750.00	25.00	<input type="checkbox"/>	---	1.0000	1.0000	1.0000	---
2.1	116550.00	45.00	<input type="checkbox"/>	---	1.0000	1.0000	1.0000	---
2.2	116550.00	45.00	<input type="checkbox"/>	---	1.0000	1.0000	1.0000	---
2.3	116550.00	45.00	<input type="checkbox"/>	---	1.0000	1.0000	1.0000	---
2.4	116550.00	45.00	<input type="checkbox"/>	---	1.0000	1.0000	1.0000	---
5.1	64750.00	25.00	<input type="checkbox"/>	---	1.0000	1.0000	1.0000	---

6 Fotball - 200 lx

6.1 Beskrivelse, Fotball - 200 lx

6.1.1 Armaturdata/Romobjekter

5.2	64750.00	25.00	<input type="checkbox"/>	---	1.0000	1.0000	1.0000	---
5.3	64750.00	25.00	<input type="checkbox"/>	---	1.0000	1.0000	1.0000	---
5.4	64750.00	25.00	<input type="checkbox"/>	---	1.0000	1.0000	1.0000	---
6.1	64750.00	25.00	<input type="checkbox"/>	---	1.0000	1.0000	1.0000	---
6.2	64750.00	25.00	<input type="checkbox"/>	---	1.0000	1.0000	1.0000	---
6.3	64750.00	25.00	<input type="checkbox"/>	---	1.0000	1.0000	1.0000	---
6.4	64750.00	25.00	<input type="checkbox"/>	---	1.0000	1.0000	1.0000	---
8.1	116550.00	45.00	<input type="checkbox"/>	---	1.0000	1.0000	1.0000	---
8.2	116550.00	45.00	<input type="checkbox"/>	---	1.0000	1.0000	1.0000	---
8.3	116550.00	45.00	<input type="checkbox"/>	---	1.0000	1.0000	1.0000	---
8.4	116550.00	45.00	<input type="checkbox"/>	---	1.0000	1.0000	1.0000	---
10.1	116550.00	45.00	<input type="checkbox"/>	---	1.0000	1.0000	1.0000	---
10.2	116550.00	45.00	<input type="checkbox"/>	---	1.0000	1.0000	1.0000	---
10.3	116550.00	45.00	<input type="checkbox"/>	---	1.0000	1.0000	1.0000	---
10.4	116550.00	45.00	<input type="checkbox"/>	---	1.0000	1.0000	1.0000	---
12.1	116550.00	45.00	<input type="checkbox"/>	---	1.0000	1.0000	1.0000	---
12.2	116550.00	45.00	<input type="checkbox"/>	---	1.0000	1.0000	1.0000	---
12.3	116550.00	45.00	<input type="checkbox"/>	---	1.0000	1.0000	1.0000	---
12.4	116550.00	45.00	<input type="checkbox"/>	---	1.0000	1.0000	1.0000	---
16.1	64750.00	25.00	<input type="checkbox"/>	---	1.0000	1.0000	1.0000	---
16.2	64750.00	25.00	<input type="checkbox"/>	---	1.0000	1.0000	1.0000	---
16.3	64750.00	25.00	<input type="checkbox"/>	---	1.0000	1.0000	1.0000	---
16.4	64750.00	25.00	<input type="checkbox"/>	---	1.0000	1.0000	1.0000	---
17.1	64750.00	25.00	<input type="checkbox"/>	---	1.0000	1.0000	1.0000	---
17.2	64750.00	25.00	<input type="checkbox"/>	---	1.0000	1.0000	1.0000	---
17.3	64750.00	25.00	<input type="checkbox"/>	---	1.0000	1.0000	1.0000	---
17.4	64750.00	25.00	<input type="checkbox"/>	---	1.0000	1.0000	1.0000	---
18.1	64750.00	25.00	<input type="checkbox"/>	---	1.0000	1.0000	1.0000	---
18.2	64750.00	25.00	<input type="checkbox"/>	---	1.0000	1.0000	1.0000	---
18.3	64750.00	25.00	<input type="checkbox"/>	---	1.0000	1.0000	1.0000	---
18.4	64750.00	25.00	<input type="checkbox"/>	---	1.0000	1.0000	1.0000	---

Philips Lighting BVP528 OUT T35 1xLED2590-4S/740/740 E3/D4I A55-MB

14.1	116550.00	45.00	<input type="checkbox"/>	---	1.0000	1.0000	1.0000	---
14.2	116550.00	45.00	<input type="checkbox"/>	---	1.0000	1.0000	1.0000	---
14.3	116550.00	45.00	<input type="checkbox"/>	---	1.0000	1.0000	1.0000	---
14.4	116550.00	45.00	<input type="checkbox"/>	---	1.0000	1.0000	1.0000	---
15.1	116550.00	45.00	<input type="checkbox"/>	---	1.0000	1.0000	1.0000	---
15.2	116550.00	45.00	<input type="checkbox"/>	---	1.0000	1.0000	1.0000	---
15.3	116550.00	45.00	<input type="checkbox"/>	---	1.0000	1.0000	1.0000	---
15.4	116550.00	45.00	<input type="checkbox"/>	---	1.0000	1.0000	1.0000	---

X : Off for general artificial light

Konstruksjonsobjekt

Virtuelt beregningsfelt

Nr.	xm[m]	ym[m]	zm[m]	Lengde	Bredde	Rotasjonsvinkel		
						z akse	lengdeakse	tverrakse
Fotball PA 105 x 66m								
m 3	0.00	0.00	0.00	105.00	66.00	0.00	0.00	0.00

6.1 Beskrivelse, Fotball - 200 lx

6.1.2 Planvisning

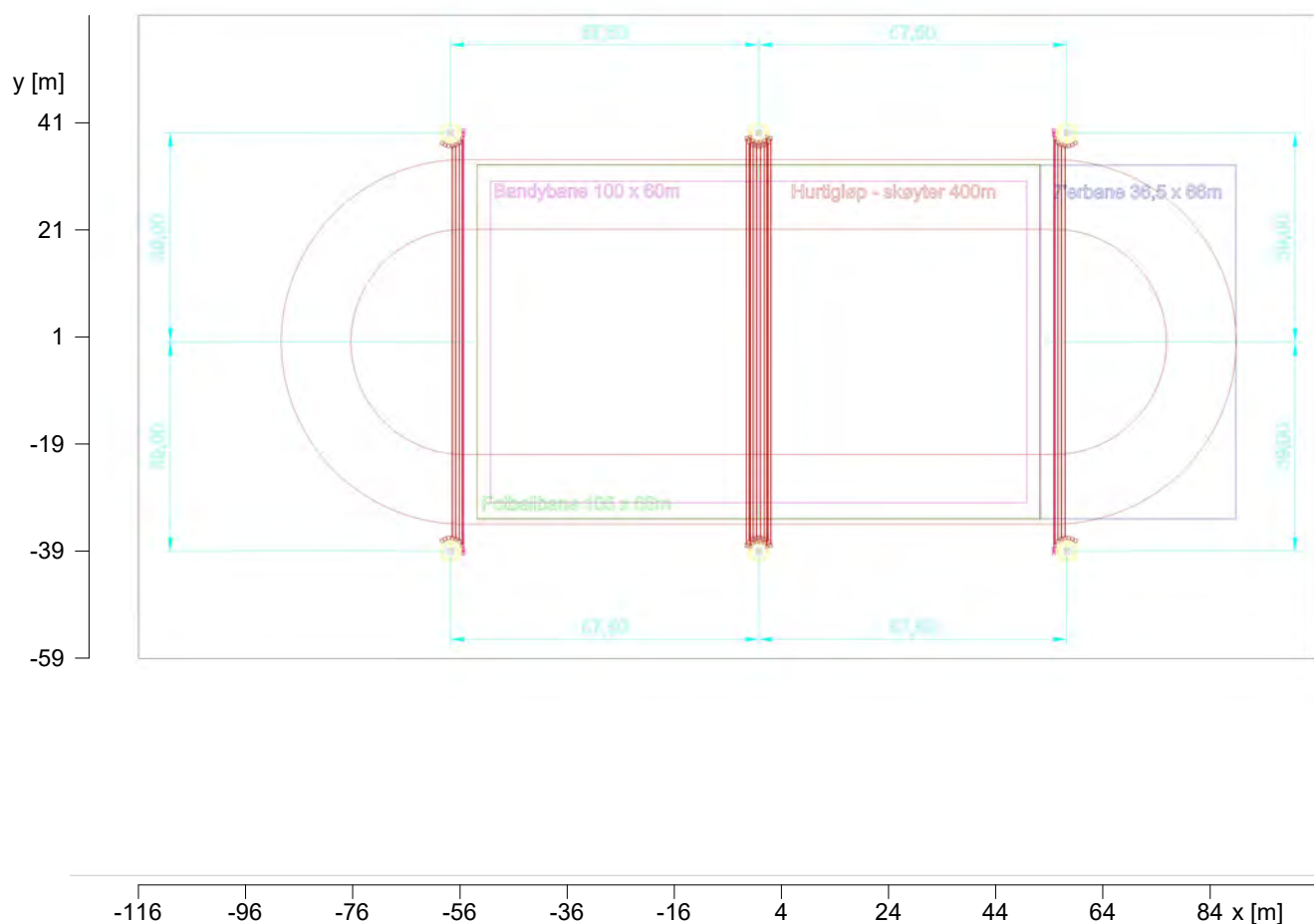

6.1 Beskrivelse, Fotball - 200 lx

6.1.3 3D visning, Vis 1

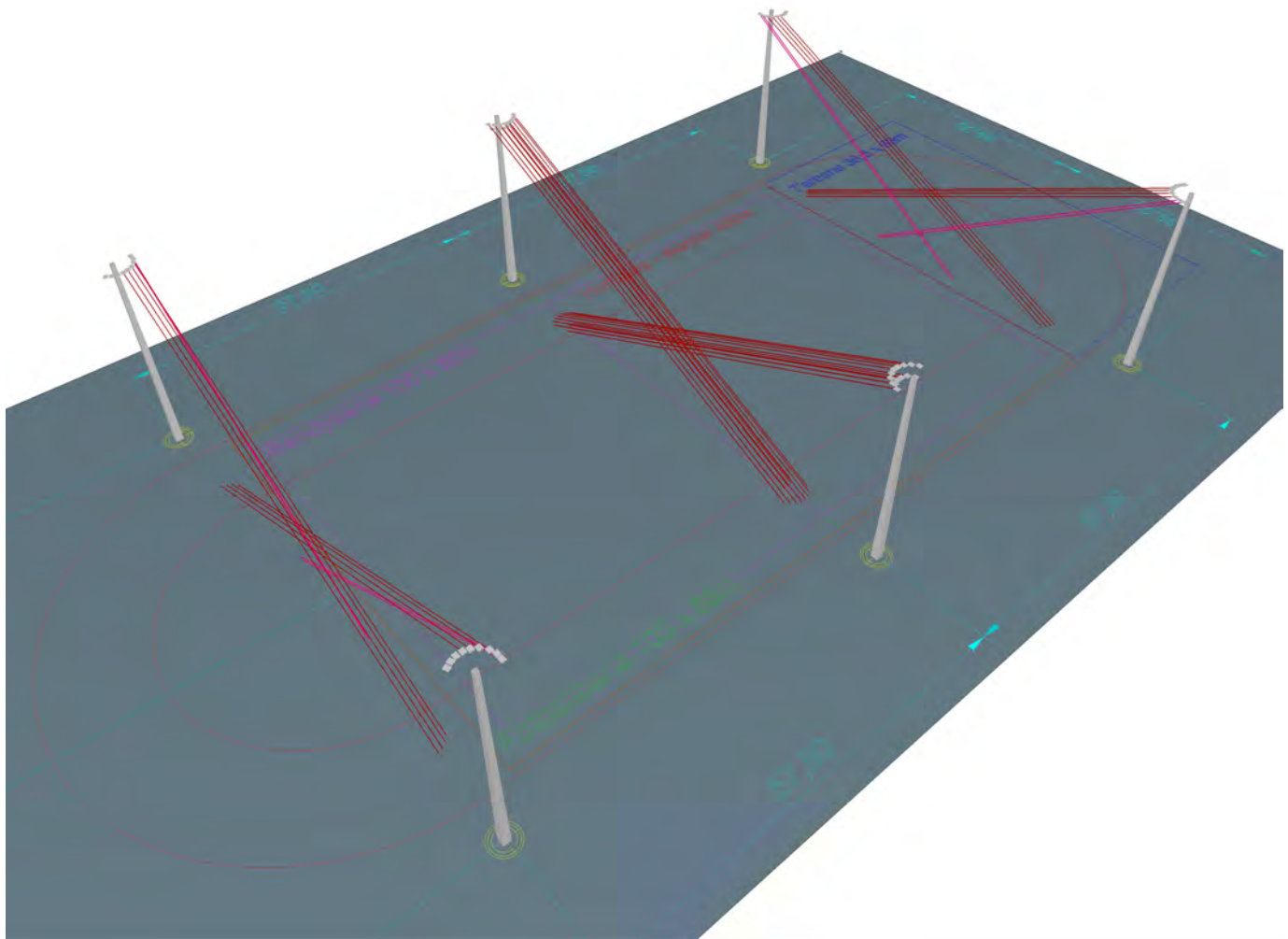

6 Fotball - 200 lx

6.2 Sammendrag, Fotball - 200 lx

6.2.1 Resultatoversikt, Fotball PA 105 x 66m

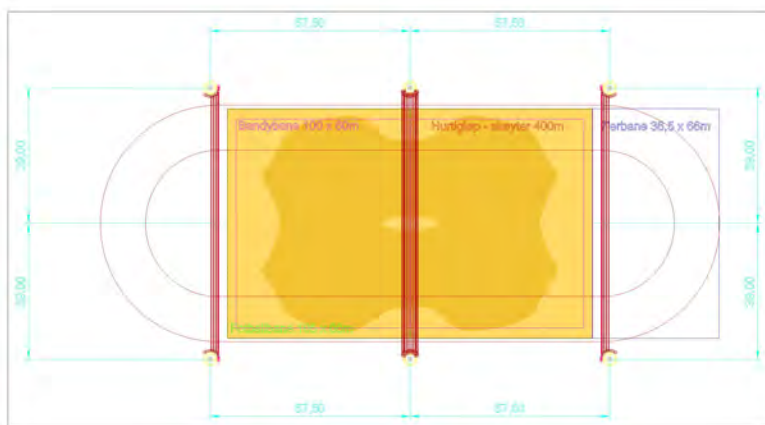

-116 -96 -76 -56 -36 -16 4 24 44 64 84 x [m]

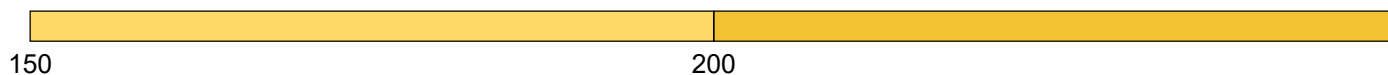

Belysningsstyrke [lx]

Generell

Anvendt beregningsalgoritme	Direkteandel
Beregningsflatens høyde	0.00 m
Vedlikeholdsfaktor	0.85

Total lysfluks 4610200 lm (34.23% dimmet)
(Luminaires have been dimmed. For details see output page "Armaturdata/Romobjekter".)

Totaleffekt	78306.8 W
Totaleffekt per areal (26377.42 m ²)	2.97 W/m ²
Upward light ratio (ULR)	0.00

Belysningsstyrke

Gjennomsnittlig belysningsstyrke	\bar{E}_m	209 lx
Laveste belysningsstyrke	E_{min}	167 lx
Største belysningsstyrke	E_{max}	254 lx
Jevnhet U_o	E_{min}/\bar{E}_m	1:1.25 (0.8)
Jevnhet U_d	E_{min}/E_{max}	1:1.52 (0.66)

RG-Tabell

0.41 cd/m², 246 lx, $\rho = 15\%$ (-2°)



$R_{G,max}$ 44.2 (h=1.60m)

Type Ant.\Prod.

6 Fotball - 200 lx

6.2 Sammendrag, Fotball - 200 lx

6.2.1 Resultatoversikt, Fotball PA 105 x 66m

		Philips Lighting	
1	44 x	Bestillingsnr.	:
		Armaturnavn	: BVP528 OUT T35 1xLED2590-4S/740/740 E3/D4I A65-NB
		Bestykning	: 1 x LED2590-4S/740 1505.9 W / 259000 lm
2	8 x	Bestillingsnr.	:
		Armaturnavn	: BVP528 OUT T35 1xLED2590-4S/740/740 E3/D4I A55-MB
		Bestykning	: 1 x LED2590-4S/740 1505.9 W / 259000 lm

6 Fotball - 200 lx

6.3 Beregningsresultat, Fotball - 200 lx

6.3.1 3D luminans, Vis 1

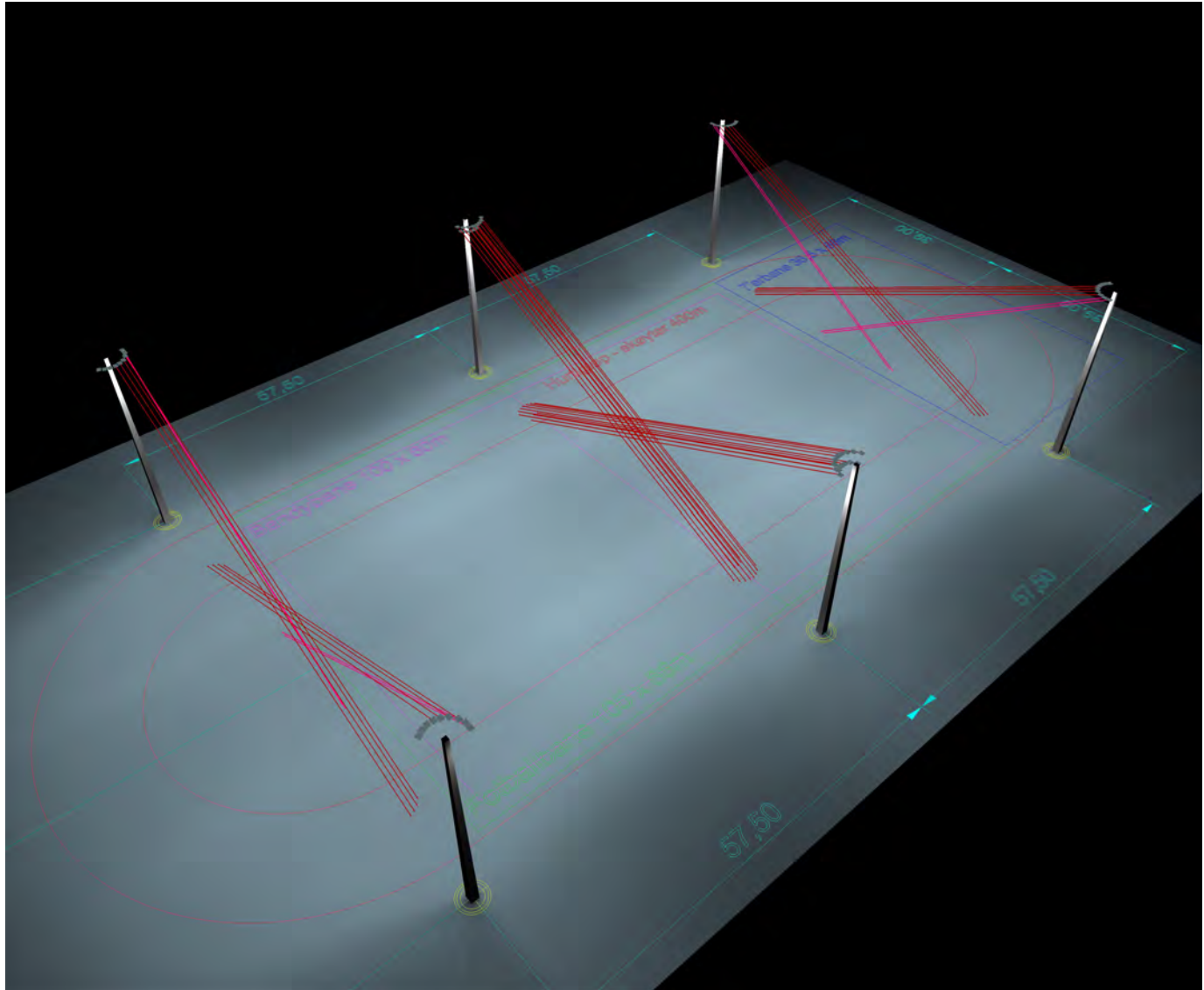

6.3 Beregningsresultat, Fotball - 200 lx

6.3.2 3D Fargeskala, Vis 1 (E)

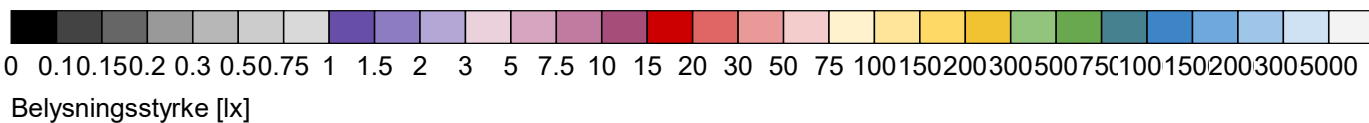
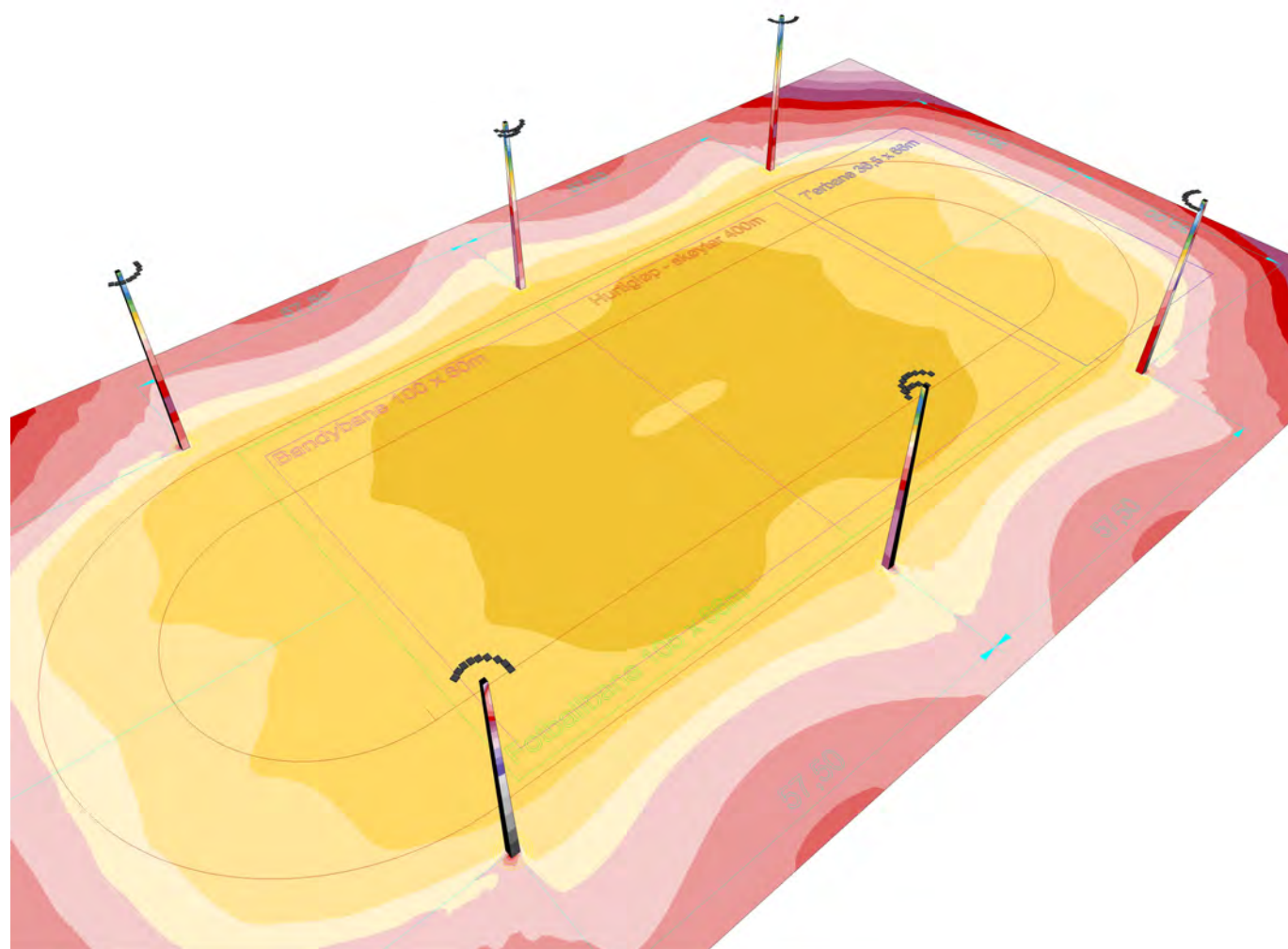



7 7'erbane - 200 lx

7.1 Beskrivelse, 7'erbane - 200 lx

7.1.1 Armaturdata/Romobjekter

Produktspesifikasjoner:

Type Ant.\Prod.

		Philips Lighting	
1	64 x	Bestillingsnr.	:
		Armaturnavn	: BVP528 OUT T35 1xLED2590-4S/740/740 E3/D4I A65-NB
		Bestykning	: 1 x LED2590-4S/740 1505.9 W / 259000 lm
2	4 x	Bestillingsnr.	:
		Armaturnavn	: BVP528 OUT T35 1xLED2590-4S/740/740 E3/D4I A55-MB
		Bestykning	: 1 x LED2590-4S/740 1505.9 W / 259000 lm

Nr.	Midtpunkt			Rotasjonsvinkel			Orienteringspunktkoordinater		
	X [m]	Y [m]	Z [m]	Z [°]	C0 [°]	C90 [°]	Xa [m]	Ya [m]	Za [m]
Philips Lighting BVP528 OUT T35 1xLED2590-4S/740/740 E3/D4I A65-NB									
X 1	-0.35	-36.50	29.34	0.00	0.00	0.00	-0.35	26.42	0.00
X 2	-0.35	36.50	29.34	180.00	0.00	0.00	-0.35	-26.42	0.00
X 3	0.35	-36.50	29.34	0.00	0.00	0.00	0.35	26.42	0.00
X 4	0.35	36.50	29.34	180.00	0.00	0.00	0.35	-26.42	0.00
X 5	-1.05	-36.75	29.34	0.00	0.00	0.00	-1.05	26.17	0.00
X 6	-1.05	36.75	29.34	180.00	0.00	0.00	-1.05	-26.17	0.00
X 7	1.05	-36.75	29.34	0.00	0.00	0.00	1.05	26.17	0.00
X 8	1.05	36.75	29.34	180.00	0.00	0.00	1.05	-26.17	0.00
X 9	-57.15	-36.55	29.34	0.00	0.00	0.00	-57.15	26.37	0.00
X 10	-57.15	36.55	29.34	180.00	0.00	0.00	-57.15	-26.37	0.00
11	57.15	-36.55	29.34	0.00	0.00	0.00	57.15	26.37	0.00
12	57.15	36.55	29.34	180.00	0.00	0.00	57.15	-26.37	0.00
X 13	-57.85	-36.55	29.34	20.00	0.00	0.00	-79.37	22.58	0.00
X 14	-57.85	36.55	29.34	160.00	0.00	0.00	-79.37	-22.58	0.00
15	57.85	-36.55	29.34	0.00	0.00	0.00	57.85	26.37	0.00
16	57.85	36.55	29.34	180.00	0.00	0.00	57.85	-26.37	0.00
X 17	-1.75	-37.20	29.34	0.00	0.00	0.00	-1.75	25.72	0.00
X 18	-1.75	37.20	29.34	180.00	0.00	0.00	-1.75	-25.72	0.00
X 19	1.75	-37.20	29.34	0.00	0.00	0.00	1.75	25.72	0.00
X 20	1.75	37.20	29.34	180.00	0.00	0.00	1.75	-25.72	0.00
X 21	-2.25	-37.95	29.34	0.00	0.00	0.00	-2.25	24.97	0.00
X 22	-2.25	37.95	29.34	180.00	0.00	0.00	-2.25	-24.97	0.00
X 23	2.25	-37.95	29.34	0.00	0.00	0.00	2.25	24.97	0.00
X 24	2.25	37.95	29.34	180.00	0.00	0.00	2.25	-24.97	0.00
X 25	-58.50	-36.75	29.34	20.00	0.00	0.00	-80.02	22.38	0.00
X 26	-58.50	36.75	29.34	160.00	0.00	0.00	-80.02	-22.38	0.00
27	58.50	-36.75	29.34	340.00	0.00	0.00	80.02	22.38	0.00
28	58.50	36.75	29.34	200.00	0.00	0.00	80.02	-22.38	0.00
X 29	-56.50	-36.75	29.34	0.00	0.00	0.00	-56.50	26.17	0.00
X 30	-56.50	36.75	29.34	180.00	0.00	0.00	-56.50	-26.17	0.00
31	56.50	-36.75	29.34	0.00	0.00	0.00	56.50	26.17	0.00
32	56.50	36.75	29.34	180.00	0.00	0.00	56.50	-26.17	0.00
X 33	-59.10	-37.10	29.34	20.00	0.00	0.00	-80.62	22.03	0.00
X 34	-59.10	37.10	29.34	160.00	0.00	0.00	-80.62	-22.03	0.00
35	59.10	-37.10	29.34	340.00	0.00	0.00	80.62	22.03	0.00

7 7'erbane - 200 lx

7.1 Beskrivelse, 7'erbane - 200 lx

7.1.1 Armaturodata/Romobjekter

36	59.10	37.10	29.34	200.00	0.00	0.00	80.62	-22.03	0.00
X 37	-55.85	-37.15	29.34	0.00	0.00	0.00	-55.85	25.77	0.00
X 38	-55.85	37.15	29.34	180.00	0.00	0.00	-55.85	-25.77	0.00
39	55.85	-37.15	29.34	0.00	0.00	0.00	55.85	25.77	0.00
40	55.85	37.15	29.34	180.00	0.00	0.00	55.85	-25.77	0.00
X 41	-59.60	-37.65	29.34	20.00	0.00	0.00	-81.12	21.48	0.00
X 42	-59.60	37.65	29.34	160.00	0.00	0.00	-81.12	-21.48	0.00
X 45	-55.30	-37.90	29.34	0.00	0.00	0.00	-55.30	25.02	0.00
X 46	-55.30	37.90	29.34	180.00	0.00	0.00	-55.30	-25.02	0.00
47	55.30	-37.90	29.34	0.00	0.00	0.00	55.30	25.02	0.00
48	55.30	37.90	29.34	180.00	0.00	0.00	55.30	-25.02	0.00
X 49	-59.90	-38.45	29.34	20.00	0.00	0.00	-81.42	20.68	0.00
X 50	-59.90	38.45	29.34	160.00	0.00	0.00	-81.42	-20.68	0.00
X 53	-55.05	-38.65	29.34	0.00	0.00	0.00	-55.05	24.27	0.00
X 54	-55.05	38.65	29.34	180.00	0.00	0.00	-55.05	-24.27	0.00
X 57	-55.05	-39.40	29.34	0.00	0.00	0.00	-55.05	23.52	0.00
X 58	-55.05	39.40	29.34	180.00	0.00	0.00	-55.05	-23.52	0.00
X 61	-0.35	-37.20	28.24	0.00	0.00	0.00	-0.35	23.36	0.00
X 62	-0.35	37.20	28.24	180.00	0.00	0.00	-0.35	-23.36	0.00
X 63	0.35	-37.20	28.24	0.00	0.00	0.00	0.35	23.36	0.00
X 64	0.35	37.20	28.24	180.00	0.00	0.00	0.35	-23.36	0.00
X 65	-1.05	-37.45	28.24	0.00	0.00	0.00	-1.05	23.11	0.00
X 66	-1.05	37.45	28.24	180.00	0.00	0.00	-1.05	-23.11	0.00
X 67	1.05	-37.45	28.24	0.00	0.00	0.00	1.05	23.11	0.00
X 68	1.05	37.45	28.24	180.00	0.00	0.00	1.05	-23.11	0.00
X 69	-1.55	-38.15	28.24	0.00	0.00	0.00	-1.55	22.41	0.00
X 70	-1.55	38.15	28.24	180.00	0.00	0.00	-1.55	-22.41	0.00
X 71	1.55	-38.15	28.24	0.00	0.00	0.00	1.55	22.41	0.00
X 72	1.55	38.15	28.24	180.00	0.00	0.00	1.55	-22.41	0.00

Philips Lighting BVP528 OUT T35 1xLED2590-4S/740/740 E3/D4I A55-MB

X 55	55.05	-38.65	29.34	0.00	0.00	0.00	55.05	8.30	0.00
X 56	55.05	38.65	29.34	180.00	0.00	0.00	55.05	-8.30	0.00
X 59	55.05	-39.40	29.34	0.00	0.00	0.00	55.05	7.55	0.00
X 60	55.05	39.40	29.34	180.00	0.00	0.00	55.05	-7.55	0.00

Dimmeverdier

Nr.	Phi [lm]	Phi [%]	T [K]	Rød	Farge Grønn	Blå	Hvit	
Philips Lighting BVP528 OUT T35 1xLED2590-4S/740/740 E3/D4I A65-NB								
11	142450.00	55.00	<input type="checkbox"/>	---	1.0000	1.0000	1.0000	---
12	142450.00	55.00	<input type="checkbox"/>	---	1.0000	1.0000	1.0000	---
15	142450.00	55.00	<input type="checkbox"/>	---	1.0000	1.0000	1.0000	---
16	142450.00	55.00	<input type="checkbox"/>	---	1.0000	1.0000	1.0000	---
27	207200.00	80.00	<input type="checkbox"/>	---	1.0000	1.0000	1.0000	---
28	207200.00	80.00	<input type="checkbox"/>	---	1.0000	1.0000	1.0000	---
31	142450.00	55.00	<input type="checkbox"/>	---	1.0000	1.0000	1.0000	---
32	142450.00	55.00	<input type="checkbox"/>	---	1.0000	1.0000	1.0000	---
35	207200.00	80.00	<input type="checkbox"/>	---	1.0000	1.0000	1.0000	---

7 7'erbane - 200 lx

7.1 Beskrivelse, 7'erbane - 200 lx

7.1.1 Armaturdata/Romobjekter

36	207200.00	80.00	<input type="checkbox"/>	---	1.0000	1.0000	1.0000	---
39	142450.00	55.00	<input type="checkbox"/>	---	1.0000	1.0000	1.0000	---
40	142450.00	55.00	<input type="checkbox"/>	---	1.0000	1.0000	1.0000	---
47	142450.00	55.00	<input type="checkbox"/>	---	1.0000	1.0000	1.0000	---
48	142450.00	55.00	<input type="checkbox"/>	---	1.0000	1.0000	1.0000	---

X : Off for general artificial light

Konstruksjonsobjekt

Virtuelt beregningsfelt

Nr.	xm[m]	ym[m]	zm[m]	Lengde	Bredde	Rotasjonsvinkel		
						z akse	lengdeakse	tverrakse
7'erbane								
m 5	52.50	-33.00	0.00	36.50	66.00	0.00	0.00	0.00

7.1 Beskrivelse, 7'erbane - 200 lx

7.1.2 Planvisning

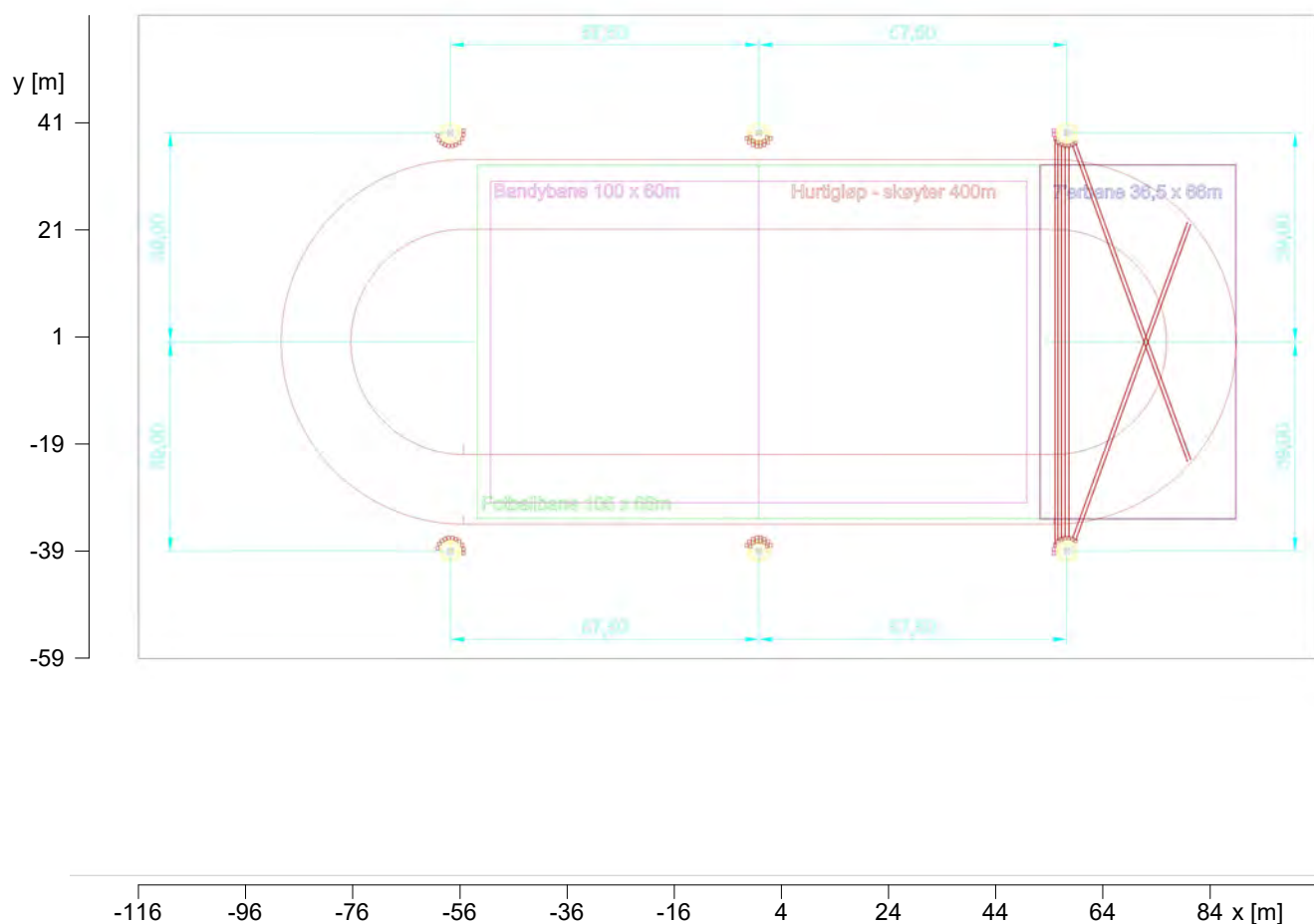

7.1 Beskrivelse, 7'erbane - 200 lx

7.1.3 3D visning, Vis 1

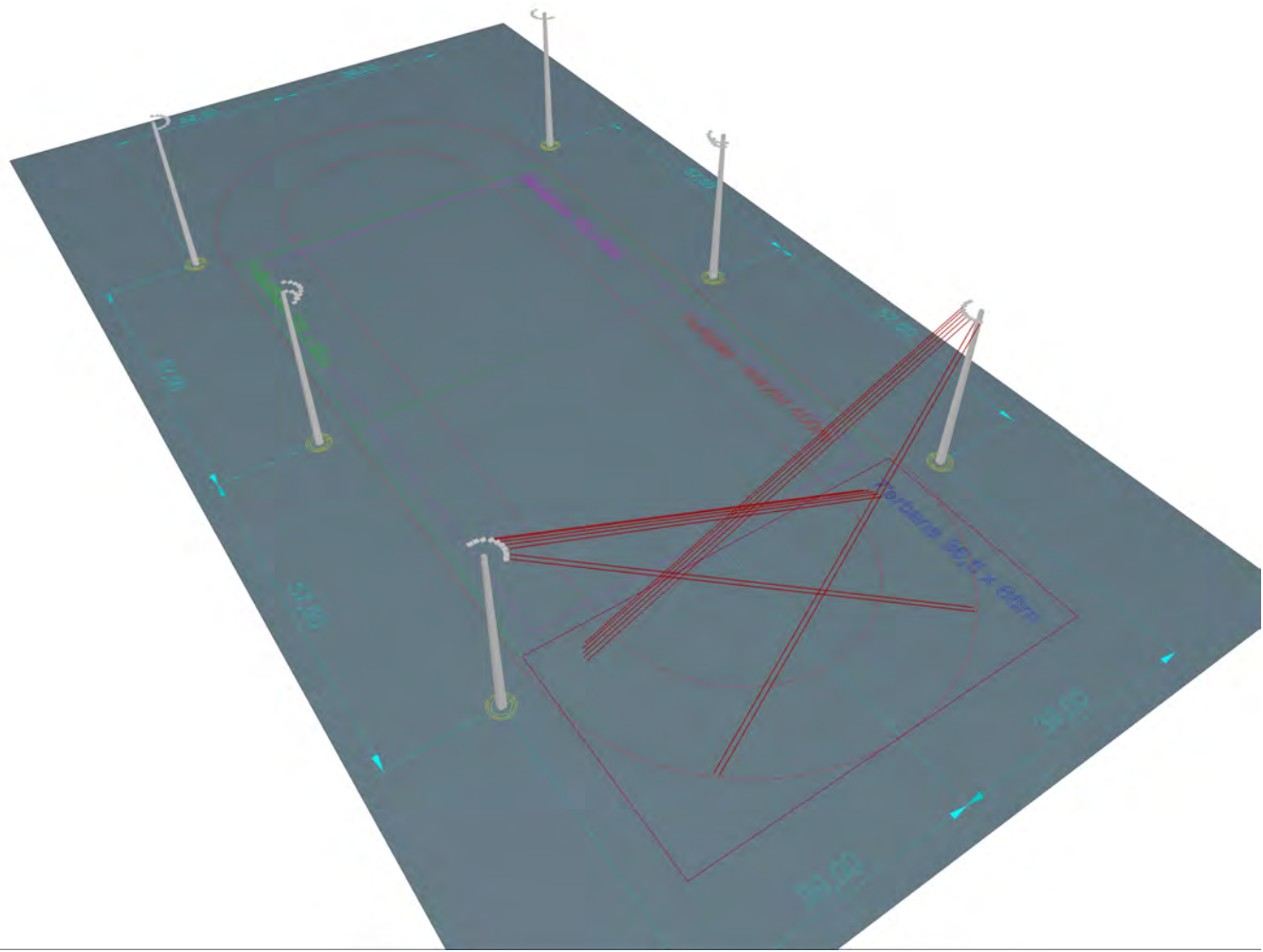

7 7'erbane - 200 lx

7.2 Sammendrag, 7'erbane - 200 lx

7.2.1 Resultatoversikt, 7'erbane

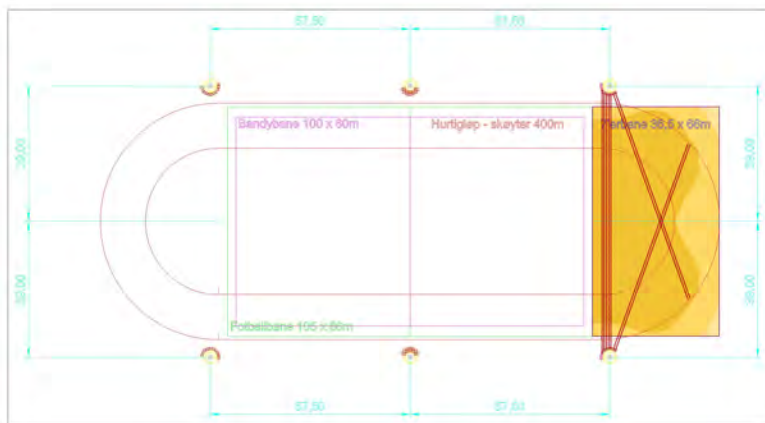

-116 -96 -76 -56 -36 -16 4 24 44 64 84 x [m]



Belysningsstyrke [lx]

Generell

Anvendt beregningsalgoritme	Direkteandel
Beregningsflatens høyde	0.00 m
Vedlikeholdsfaktor	0.85

Total lysfluks 2253300 lm (62.14% dimmet)
 (Luminaires have been dimmed. For details see output page "Armaturdata/Romobjekter".)

Totaleffekt	21082.6 W
Totaleffekt per areal (26377.42 m ²)	0.80 W/m ²
Upward light ratio (ULR)	0.00

Belysningsstyrke

Gjennomsnittlig belysningsstyrke	\bar{E}_m	212 lx
Laveste belysningsstyrke	E_{min}	134 lx
Største belysningsstyrke	E_{max}	257 lx
Jevnhet U_o	E_{min}/\bar{E}_m	1:1.59 (0.63)
Jevnhet U_d	E_{min}/E_{max}	1:1.93 (0.52)

RG-Tabell

0.42 cd/m², 250 lx, $\rho = 15\%$ (-2°)

$R_{G,max}$ 45.3 (h=1.60m)

Type Ant.\Prod.

Objekt : Marienlyst Idrettspark
Anleggsdel : Kunstisbane
Prosjektnummer : T231002A
Dato : 02.10.2023

7 7'erbane - 200 lx

7.2 Sammendrag, 7'erbane - 200 lx

7.2.1 Resultatoversikt, 7'erbane

1	14 x	Philips Lighting	
		Bestillingsnr.	:
		Armaturnavn	: BVP528 OUT T35 1xLED2590-4S/740/740 E3/D4I A65-NB
		Bestykning	: 1 x LED2590-4S/740 1505.9 W / 259000 lm

7 7'erbane - 200 lx

7.3 Beregningsresultat, 7'erbane - 200 lx

7.3.1 3D luminans, Vis 1

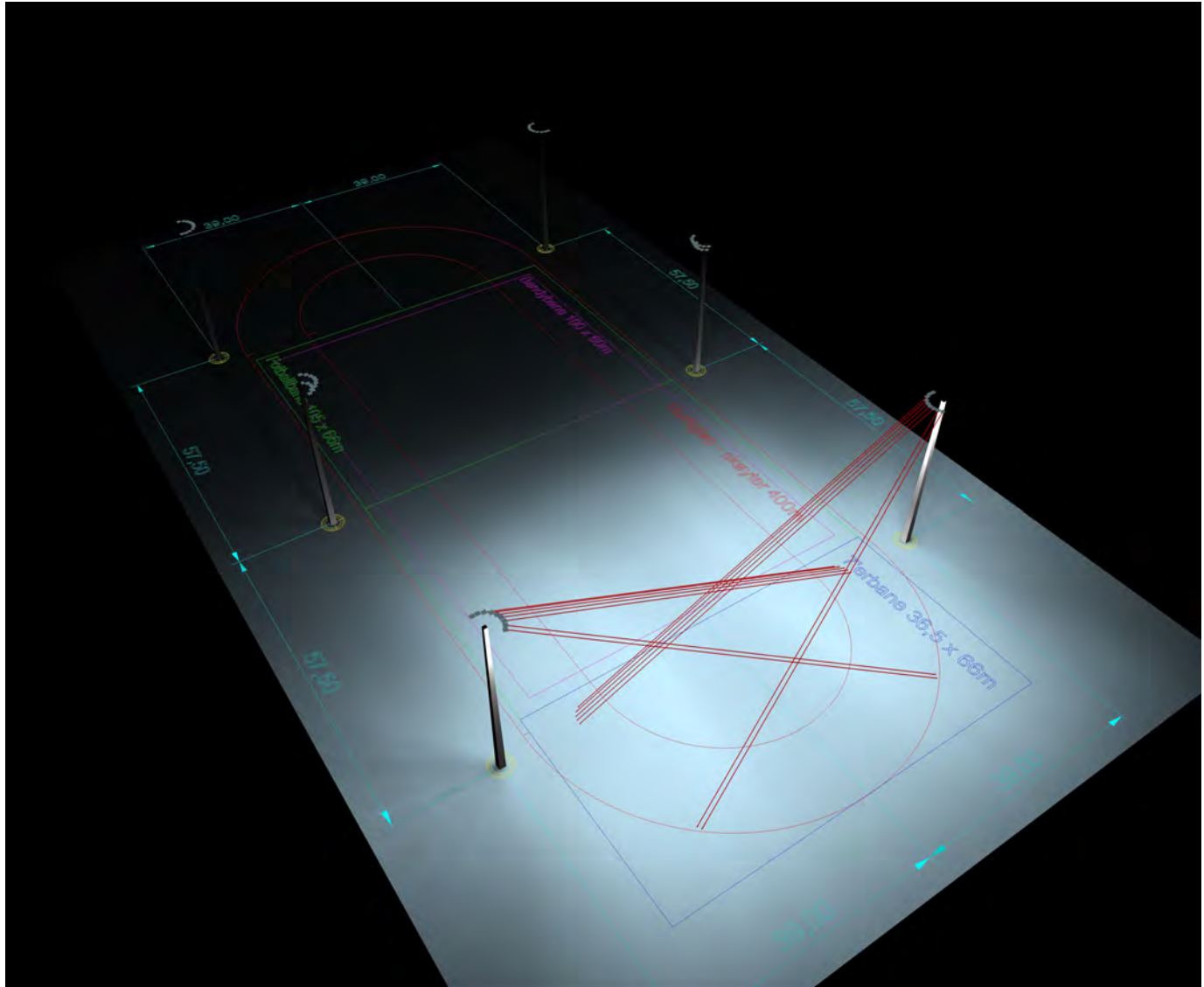

7.3 Beregningsresultat, 7'erbane - 200 lx

7.3.2 3D Fargeskala, Vis 1 (E)

