



 100 mm recess

 Recess in the cabin immersion

Notes

5391 Bjerkreim Helsesenter

Sketch - Type 1

Internal height 270 cm	Complete cabin weight ca. 4300 kg	Revision 0	External m ² 6,10 m ²	Internal m ² 5,66 m ²
Date 11.10.2023	Side 1/1	Scale 1:20	 Fremtidens baderom	
Drawn by Karol Siedlecki	Signature			

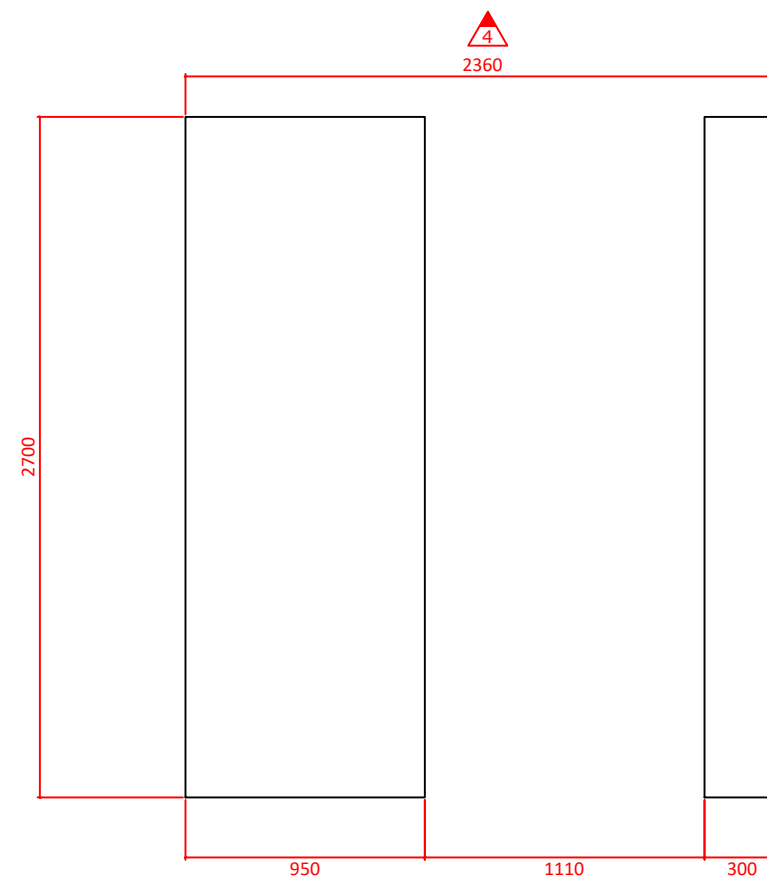
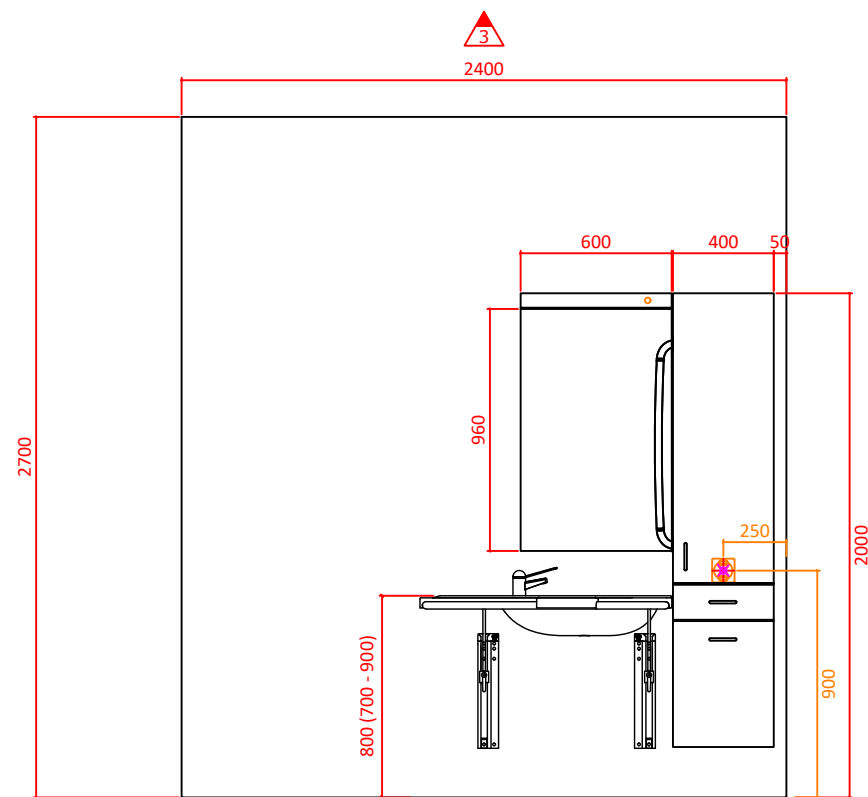
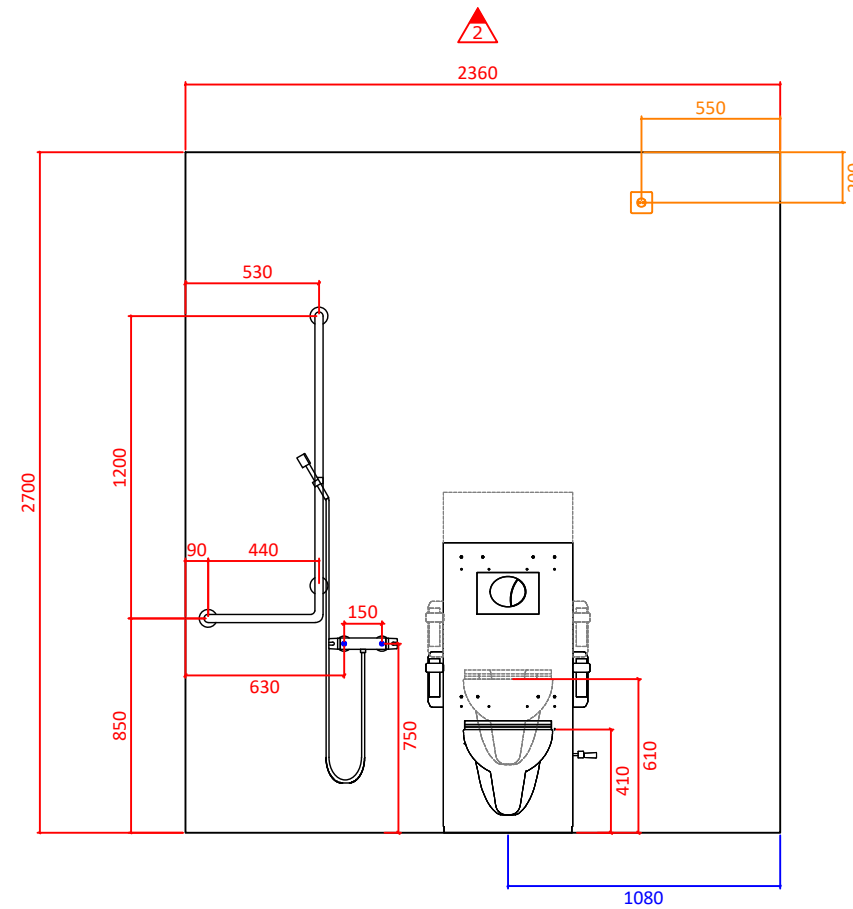
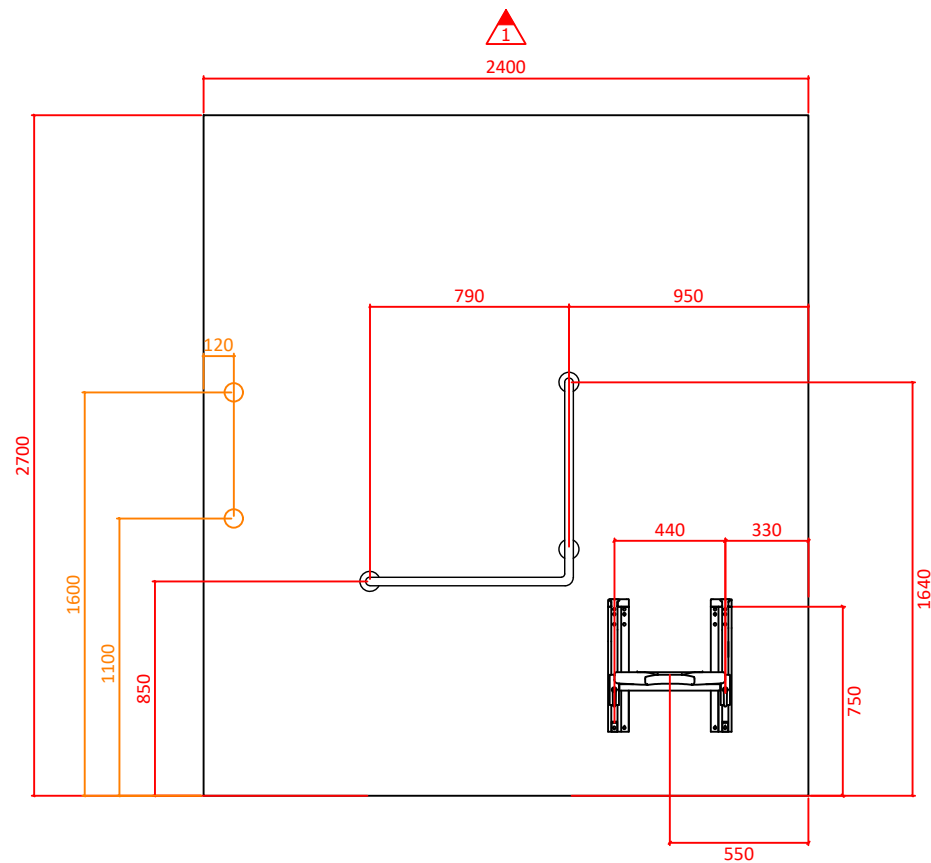

Notes:
1.

5391 Bjerkreim Helsesenter

Equipment - Type 1

Internal height 270 cm	Complete cabin weight ca. 4300 kg	Revision 0	External m ² 6,10 m ²	Internal m ² 5,66 m ²
Date 11.10.2023	Side 1/1	Scale 1:30	 Fremtidens badrom	
Drawn by Karol Siedlecki	Signature			

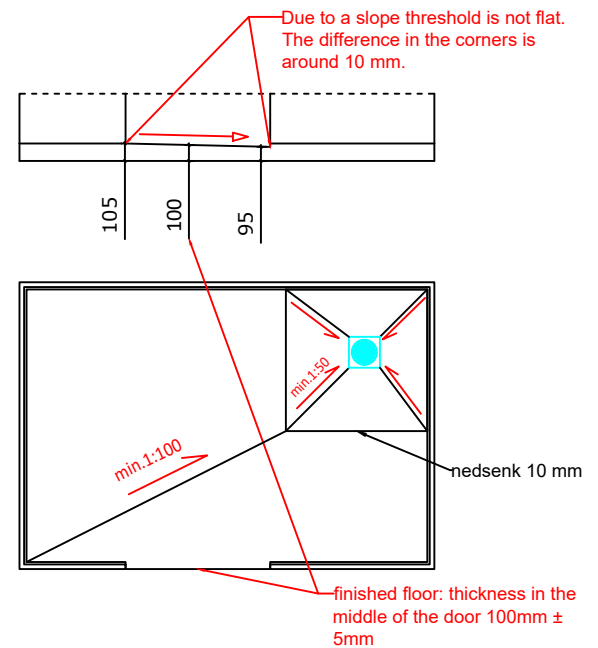
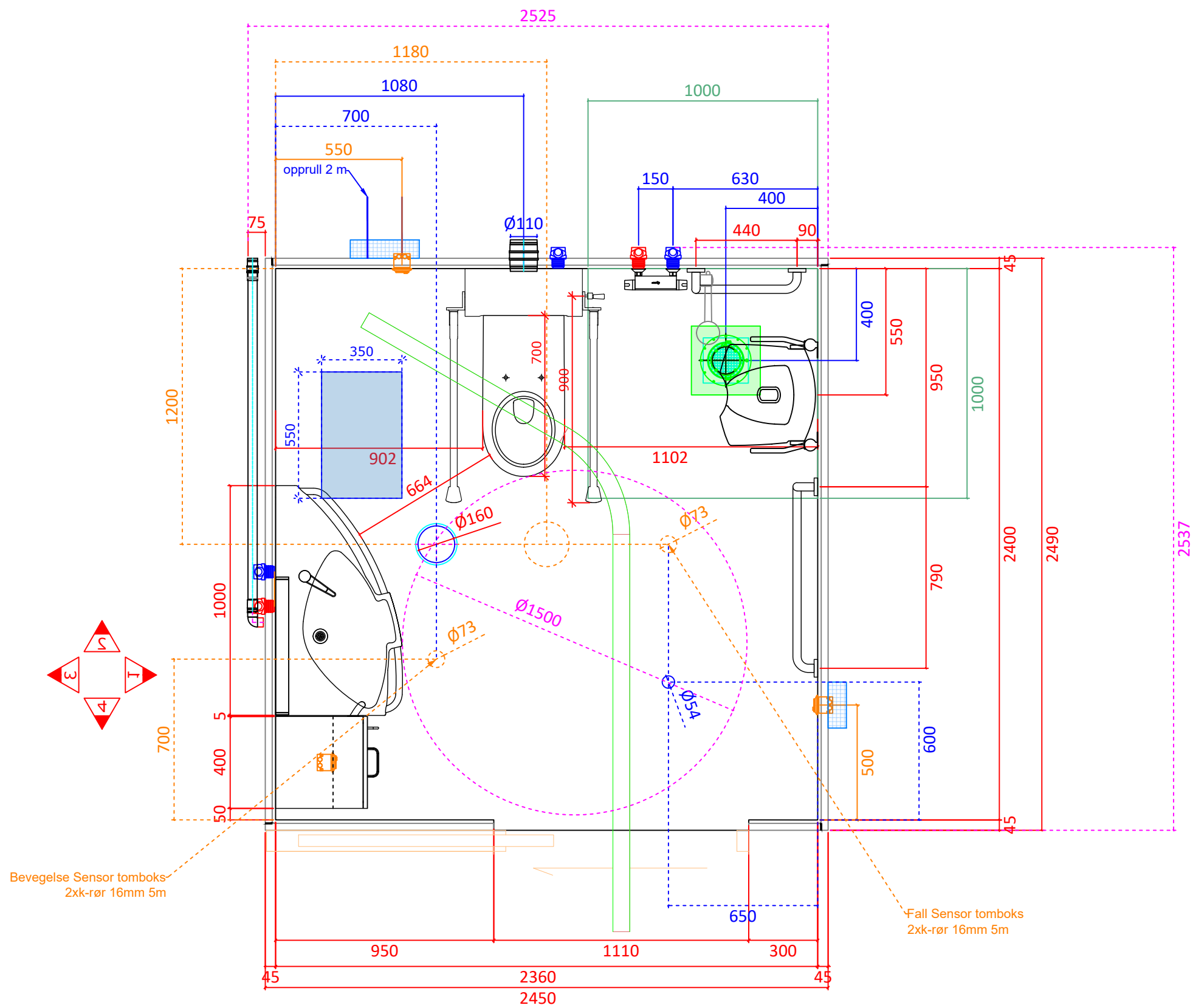

100 mm recess

Recess in the cabin immersion

Notes

5391 Bjerkreim Helsesenter

Sketch - Type 1-s

Internal height 270 cm	Complete cabin weight ca. 4300 kg	Revision 0	External m ² 6,10 m ²	Internal m ² 5,66 m ²
Date 11.10.2023	Side 1/1	Scale 1:20	 Fremtidens baderom	
Drawn by Karol Siedlecki	Signature			

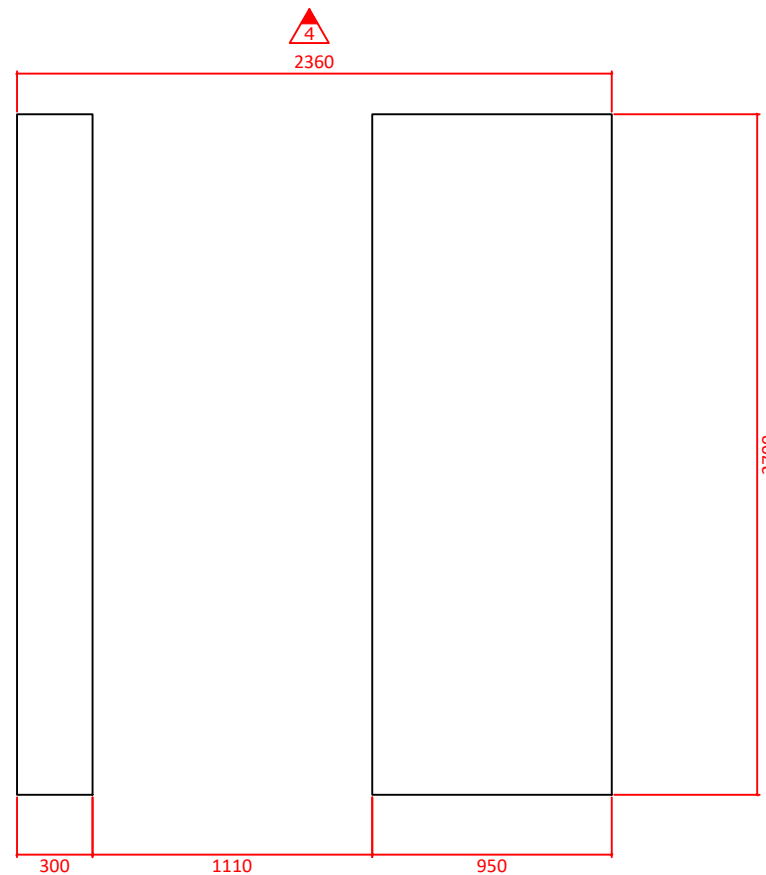
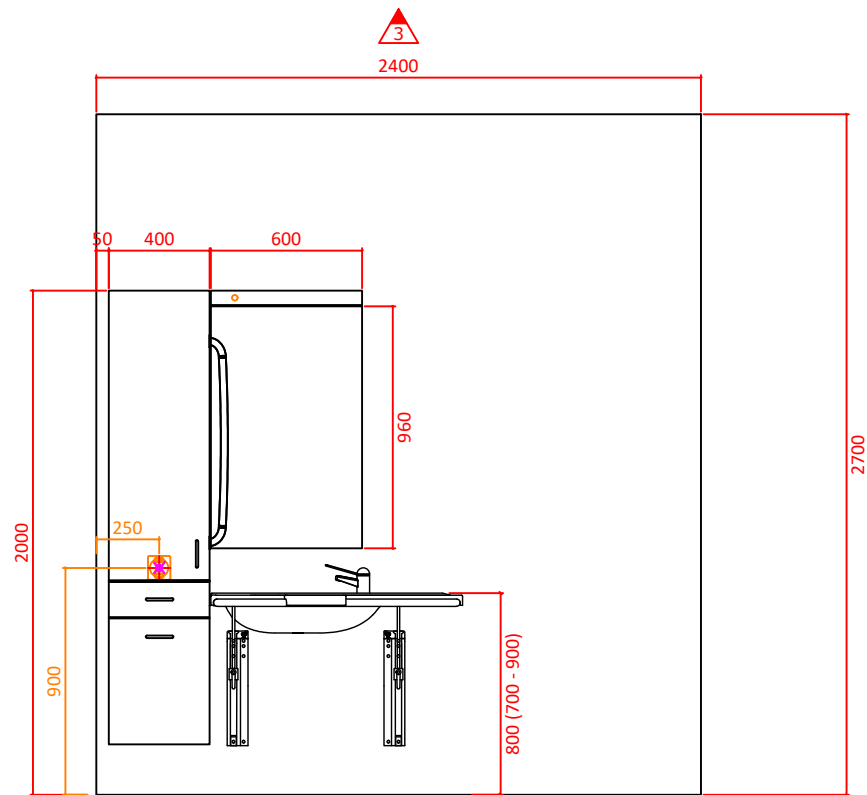
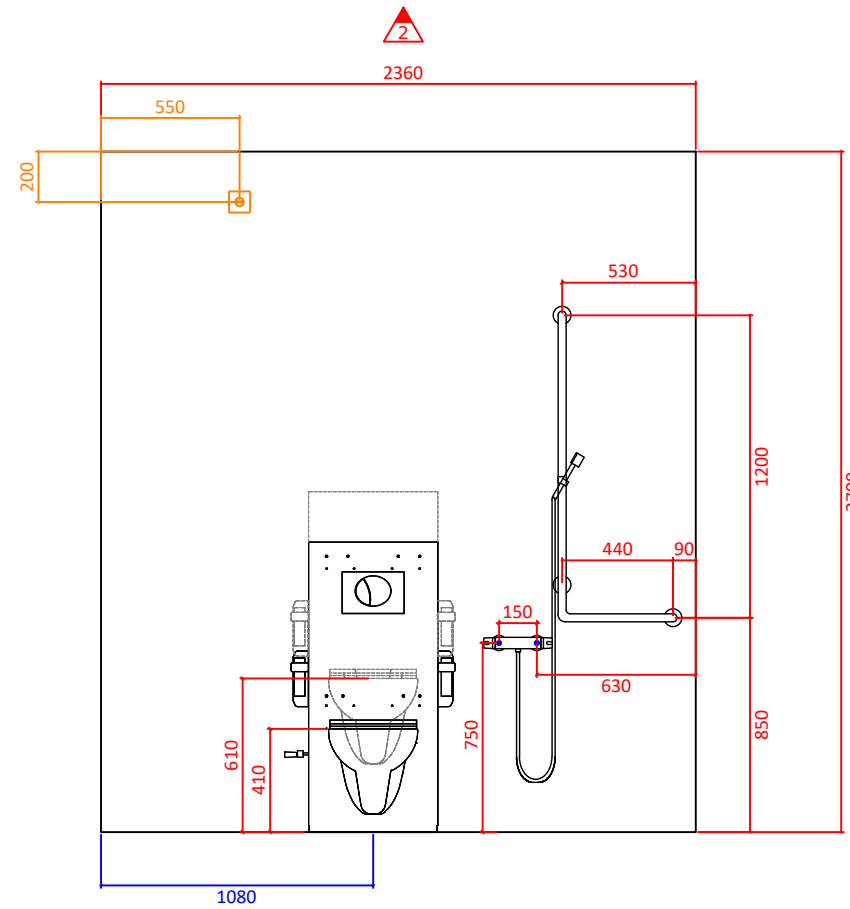
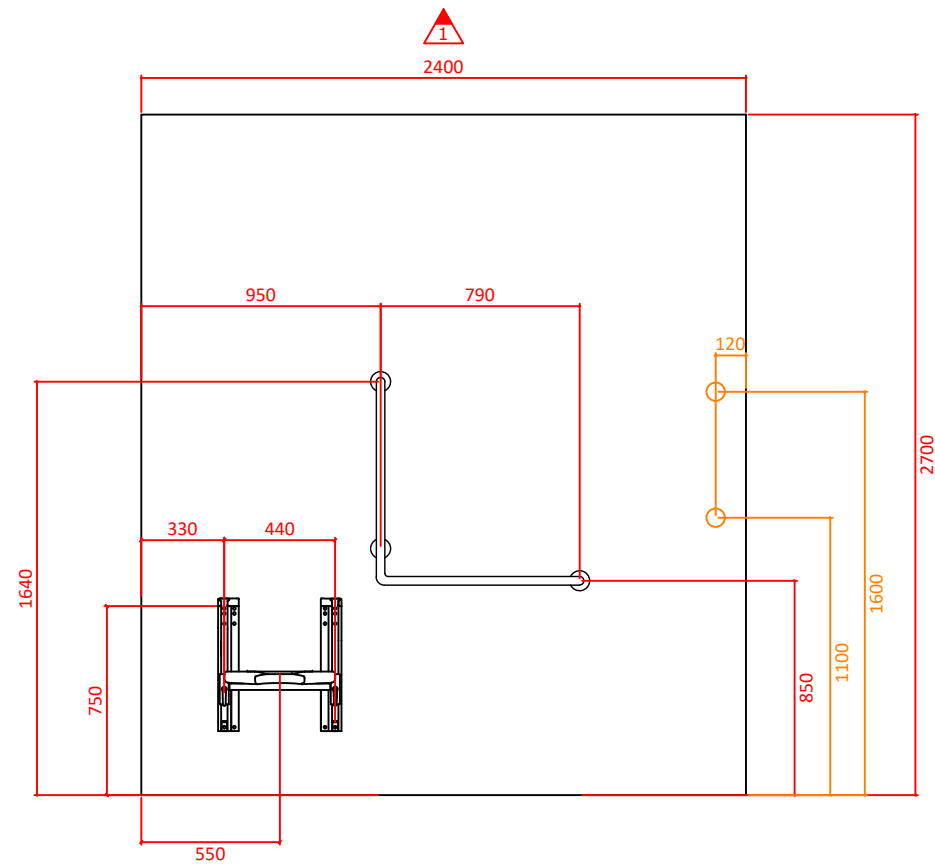

Notes:
1.

5391 Bjerkreim Helsesenter

Equipment - Type 1-s

Internal height 270 cm	Complete cabin weight ca. 4300 kg	Revision 0	External m ² 6,10 m ²	Internal m ² 5,66 m ²
Date 11.10.2023	Side 1/1	Scale 1:30	Fremtidens baderom	
Drawn by Karol Siedlecki	Signature			

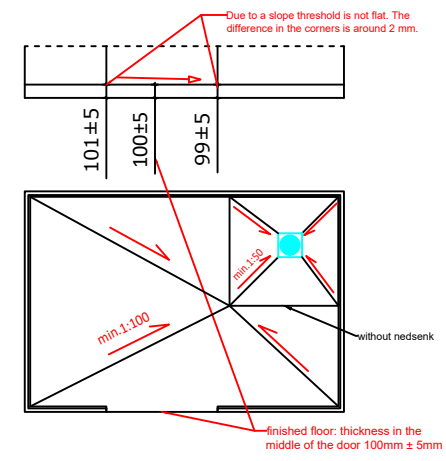
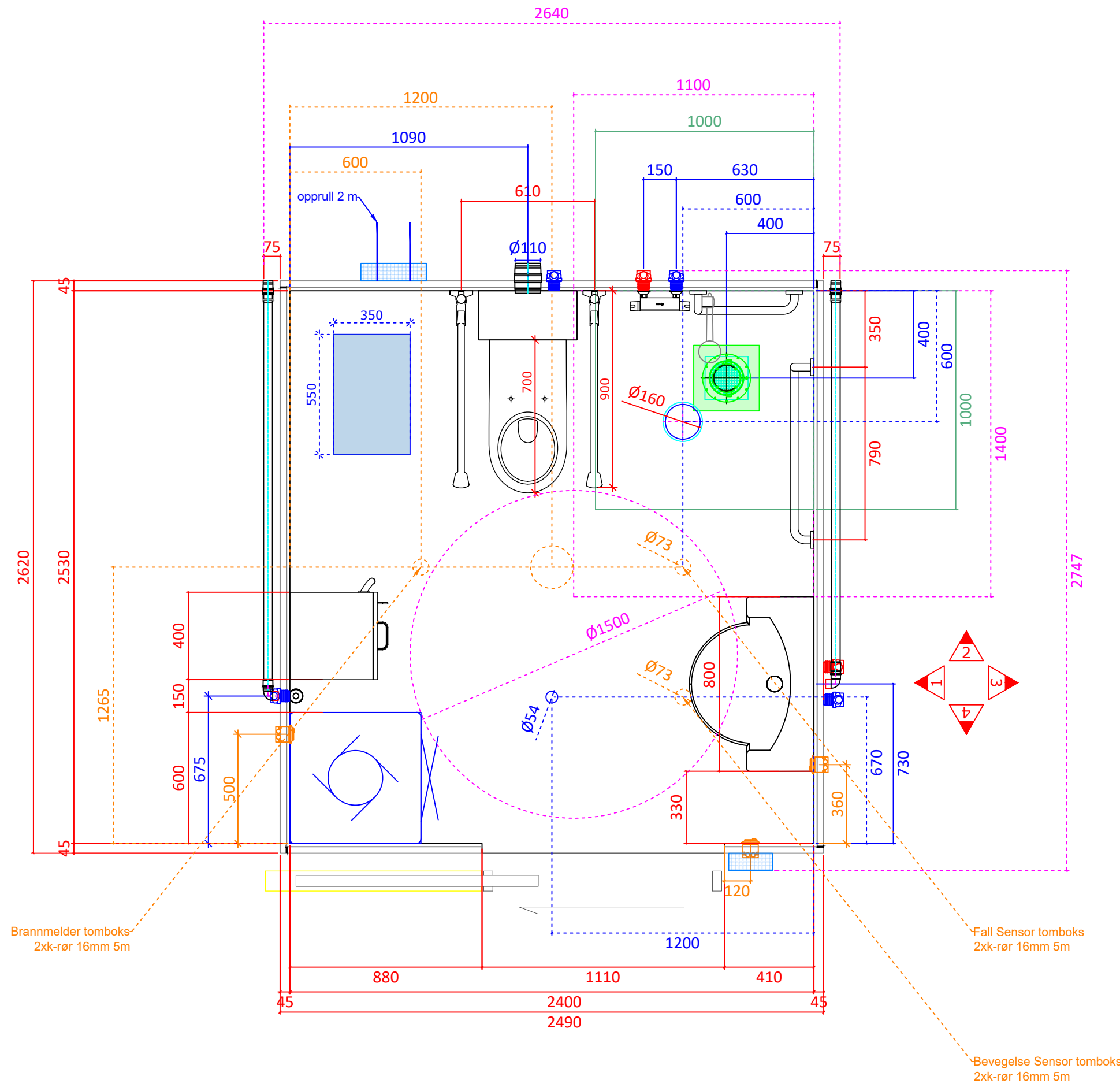

100 mm recess
 Recess in the cabin immersion

Notes

5391 Bjerkreim Helsesenter

Sketch - Type 2

Internal height 270 cm	Complete cabin weight ca. 4500 kg	Revision 0	External m ² 6,52 m ²	Internal m ² 6,07 m ²
Date 11.10.2023	Side 1/1	Scale 1:20	Fremtidens baderom	
Drawn by Karol Siedlecki	Signature			

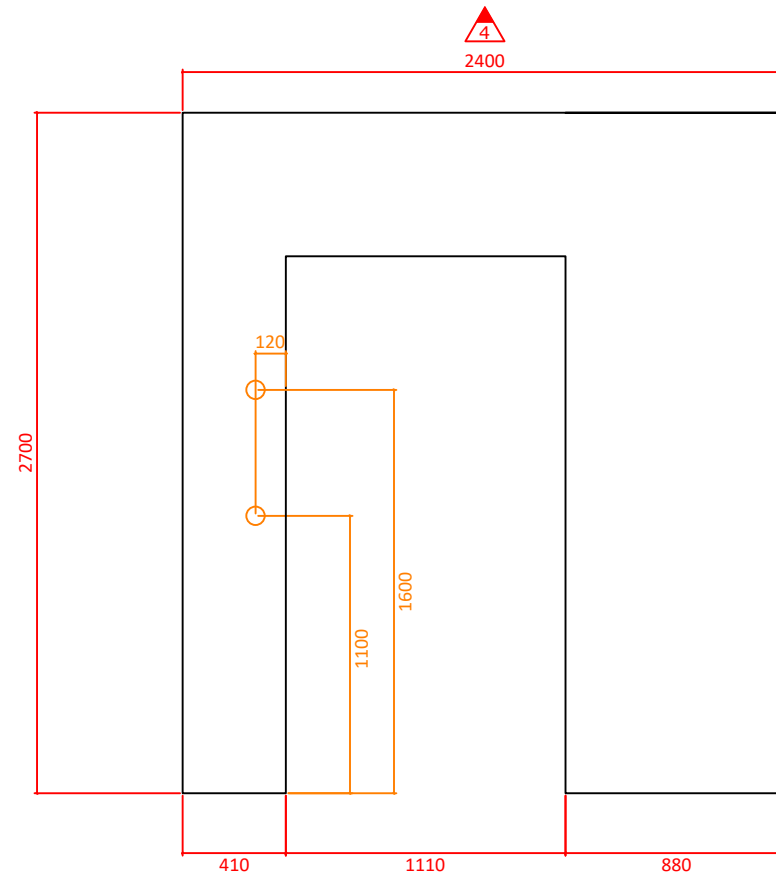
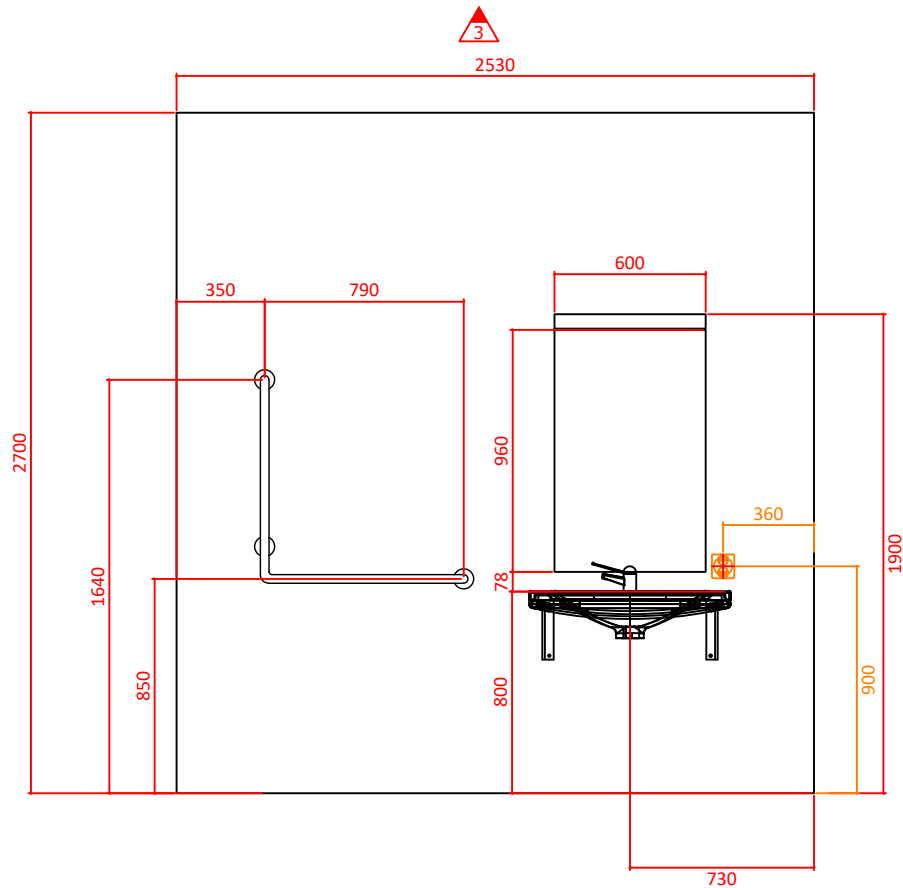
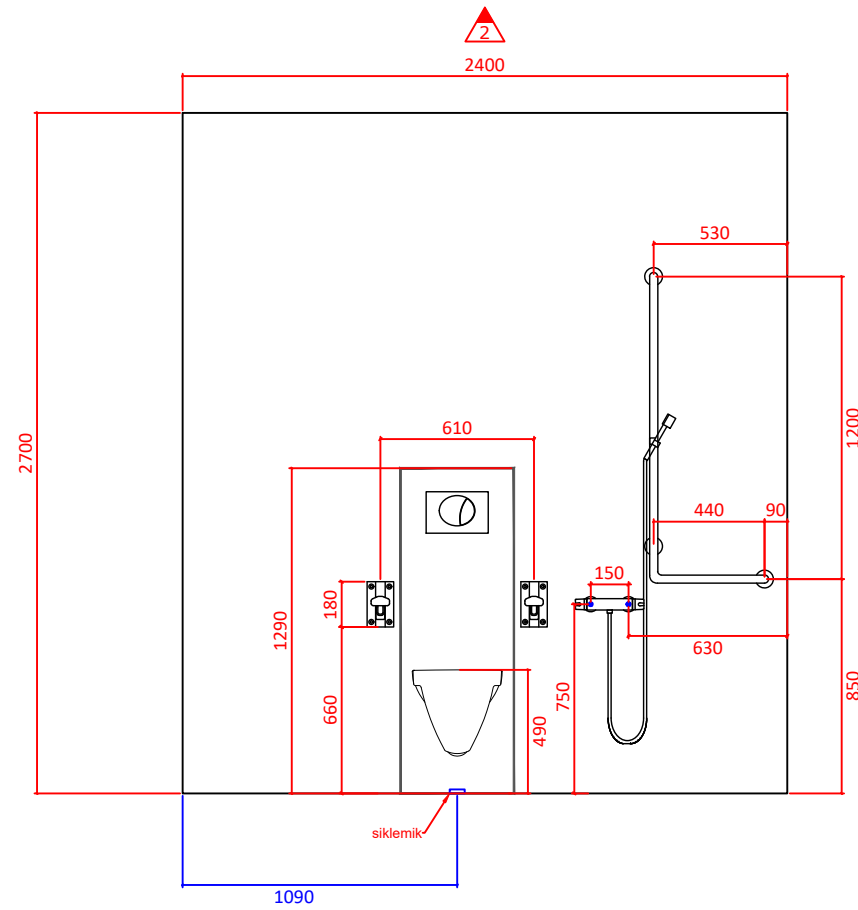
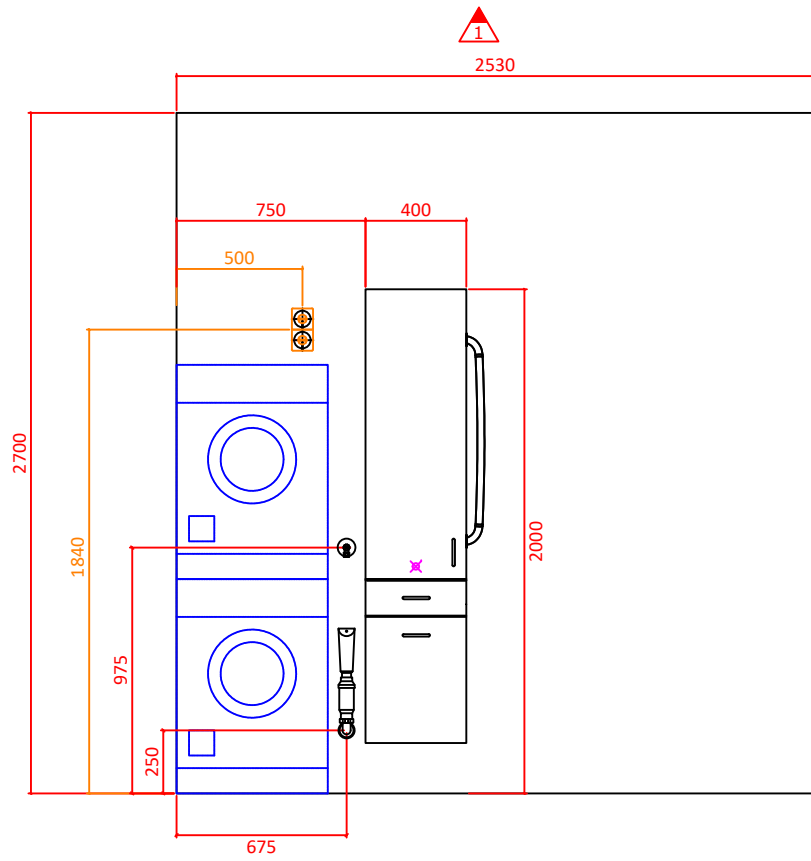

Notes:
1.

5391 Bjerkreim Helsesenter

Equipment - Type 2

Internal height 270 cm	Complete cabin weight ca. 4500 kg	Revision 0	External m ² 6,52 m ²	Internal m ² 6,07 m ²
Date 11.10.2023	Side 1/1	Scale 1:30	 Fremtidens badrom	
Drawn by Karol Siedlecki	Signature			

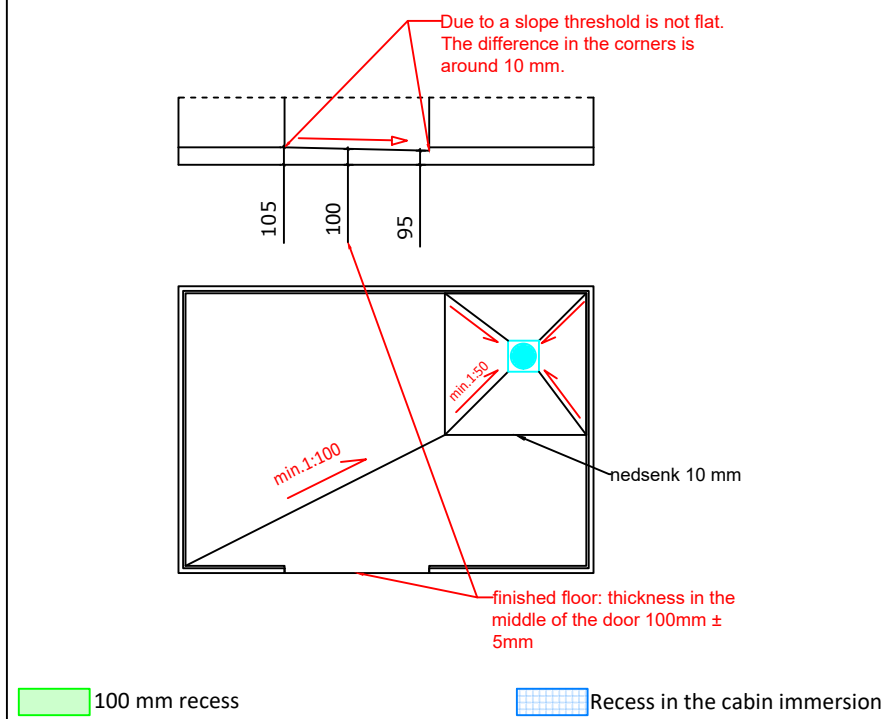
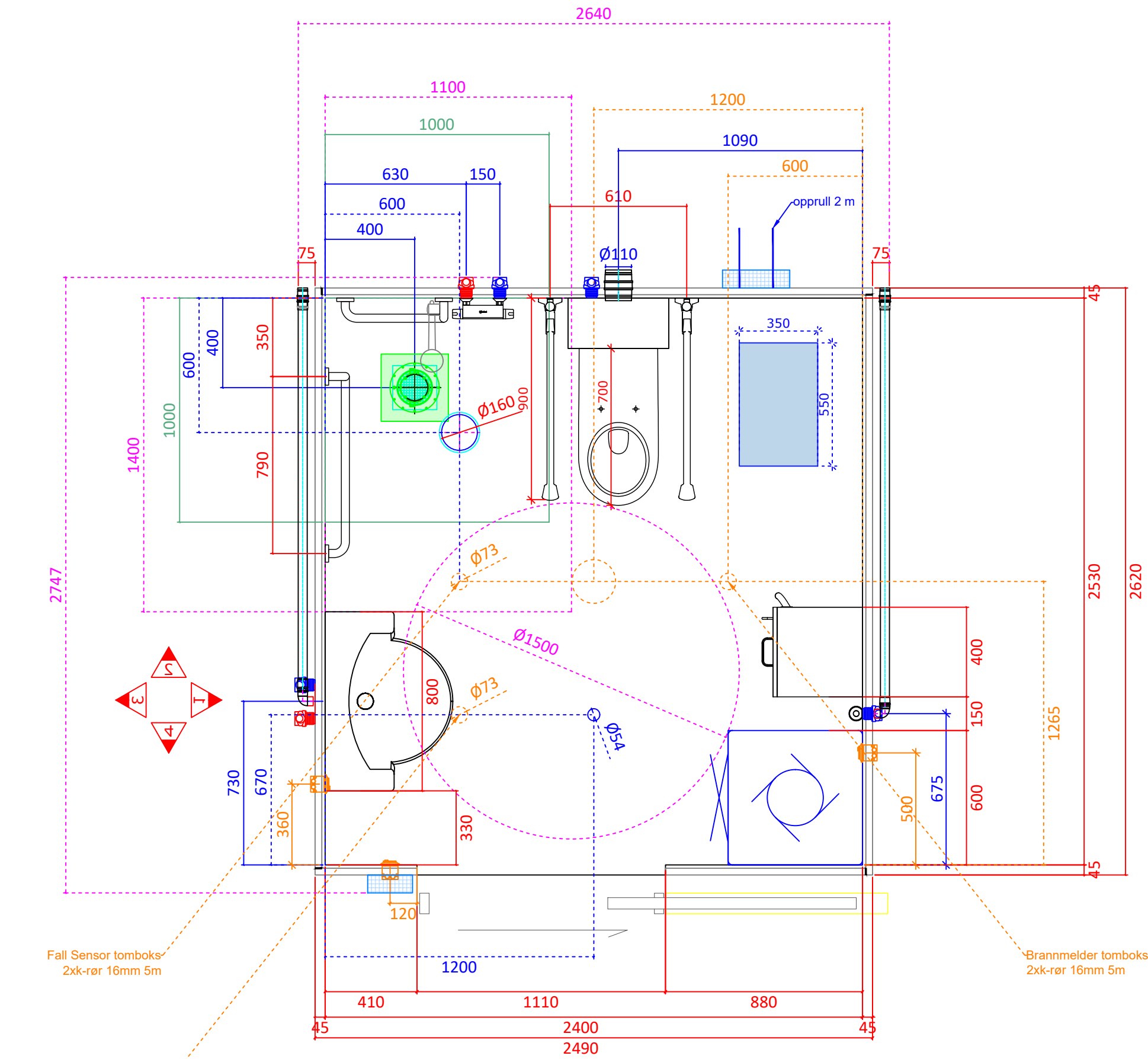

Notes

5391 Bjerkreim Helsesenter

Sketch - Type 2-s

Internal height 270 cm	Complete cabin weight ca. 4500 kg	Revision 0	External m ² 6,52 m ²	Internal m ² 6,07 m ²
Date 11.10.2023	Side 1/1	Scale 1:20	 Fremtidens baderom	
Drawn by Karol Siedlecki	Signature			

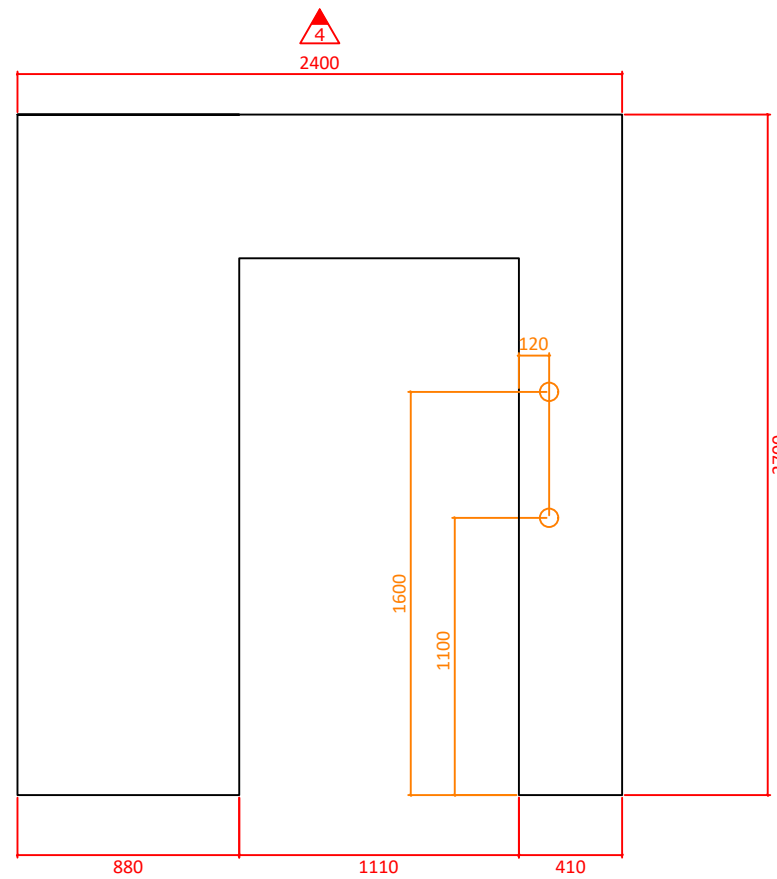
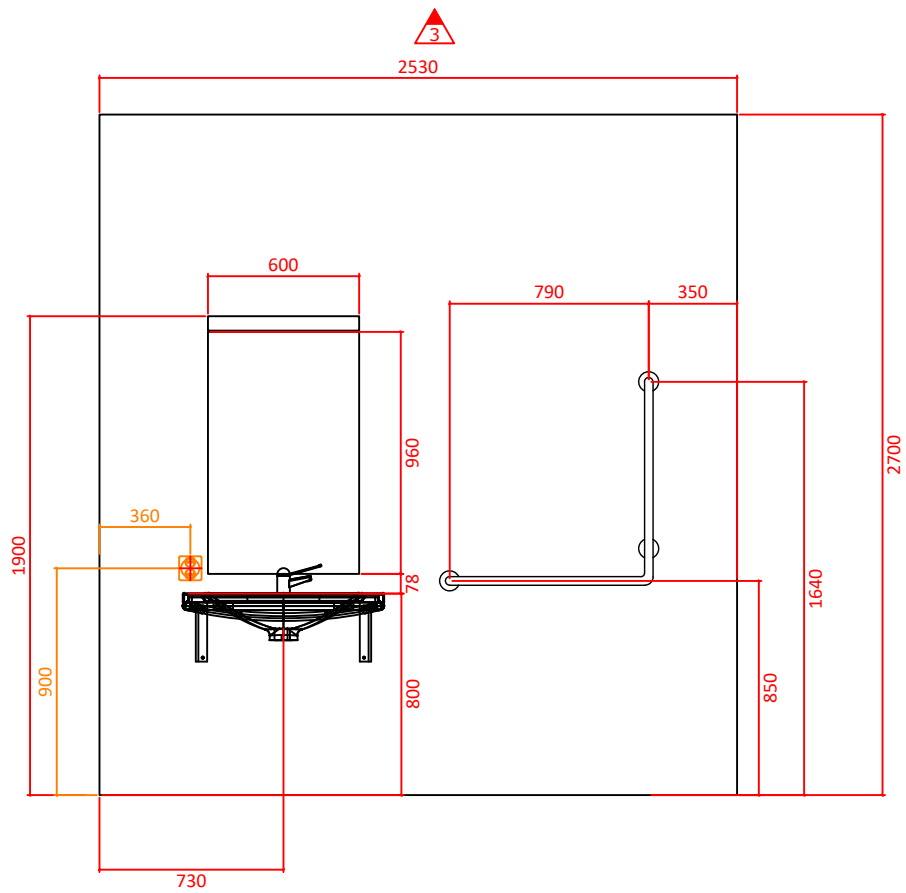
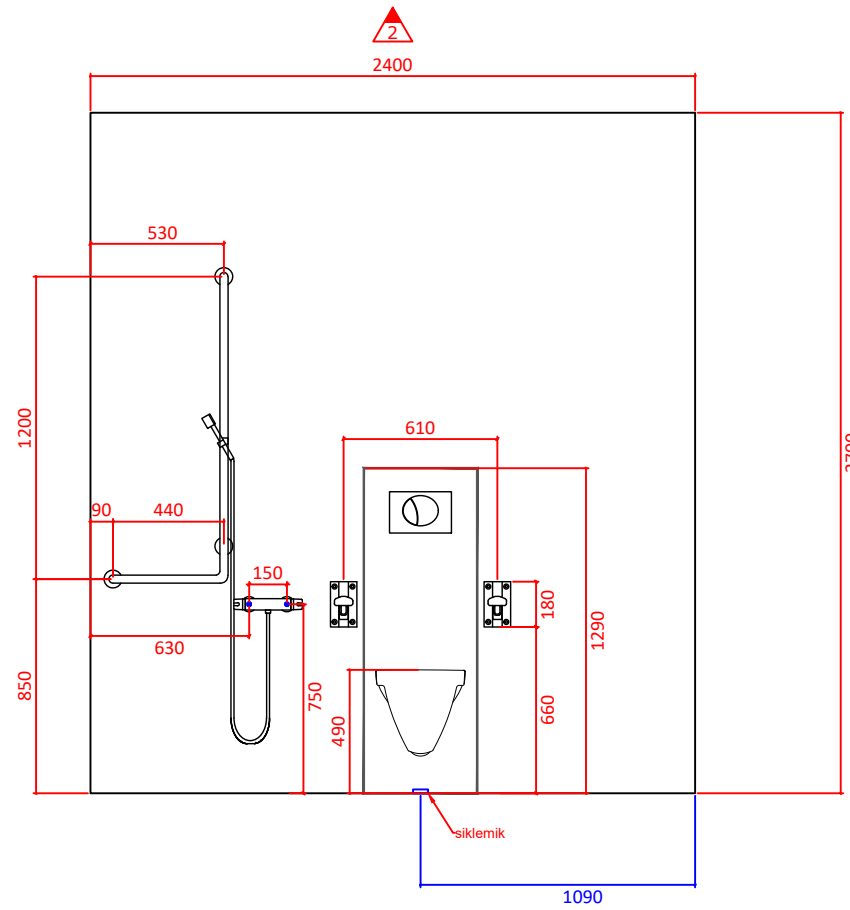
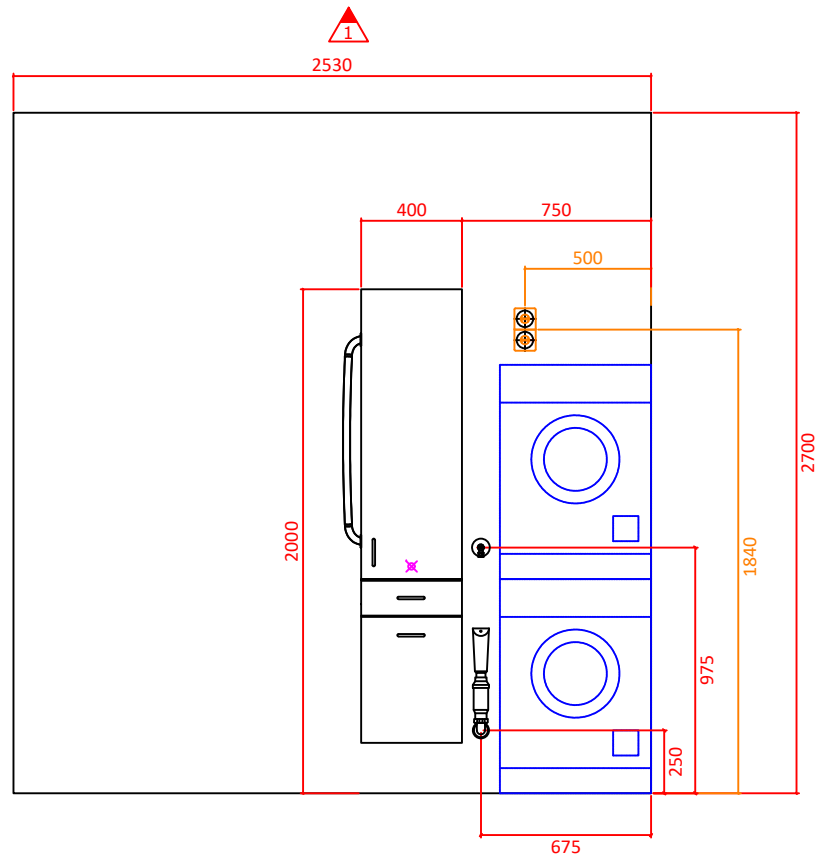

Notes:
1.

5391 Bjerkreim Helsesenter

Equipment - Type 2-s

Internal height 270 cm	Complete cabin weight ca. 4500 kg	Revision 0	External m ² 6,52 m ²	Internal m ² 6,07 m ²
Date 11.10.2023	Side 1/1	Scale 1:30	Fremtidens baderom	
Drawn by Karol Siedlecki	Signature			

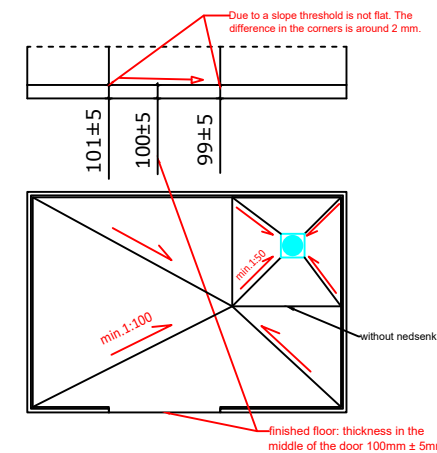
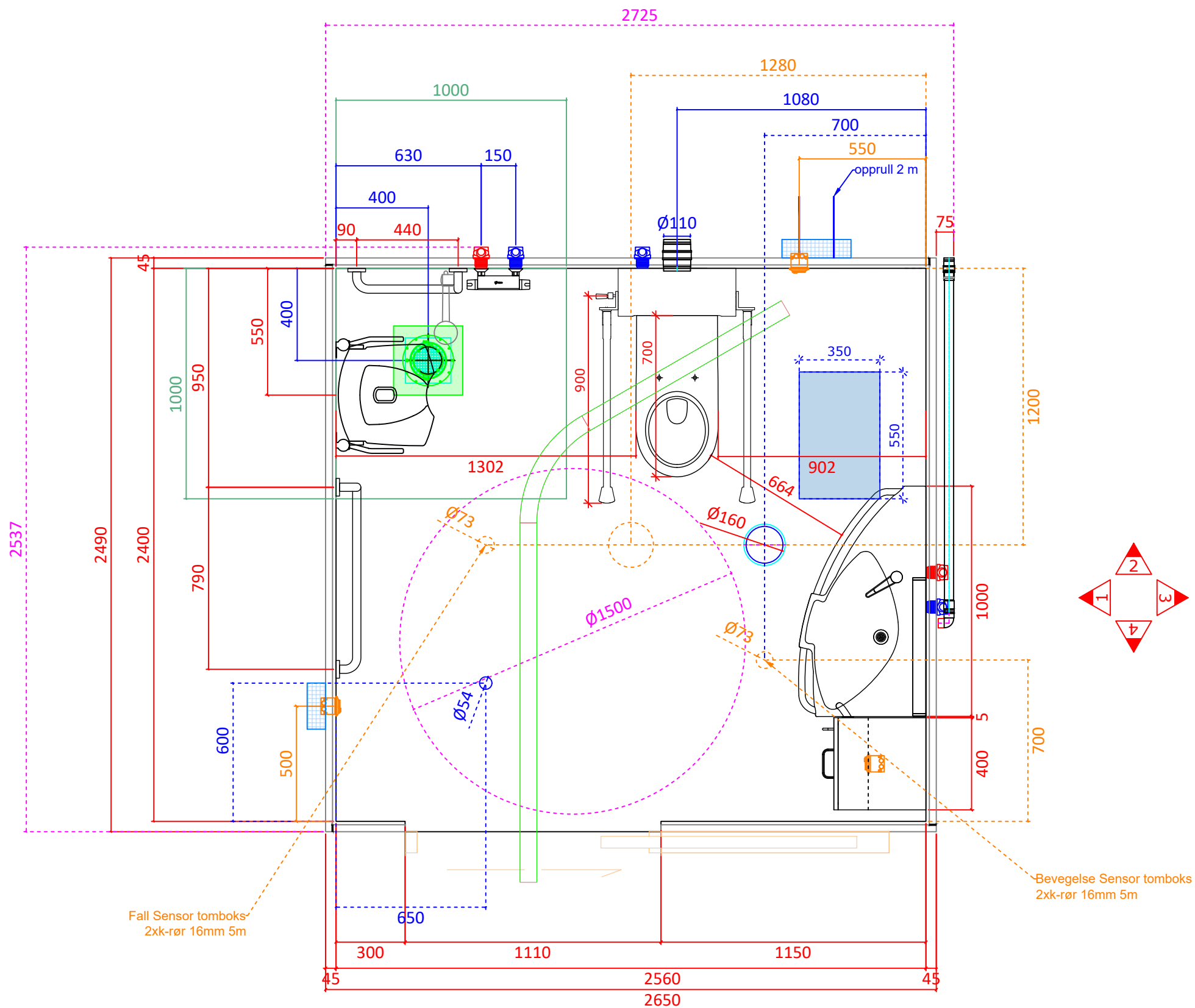

100 mm recess

Recess in the cabin immersion

Notes

5391 Bjerkreim Helsesenter

Sketch - Type 3

Internal height 270 cm	Complete cabin weight ca. 4500 kg	Revision 0	External m ² 6,60 m ²	Internal m ² 6,14 m ²
Date 11.10.2023	Side 1/1	Scale 1:20	 Fremtidens baderom	
Drawn by Karol Siedlecki	Signature			

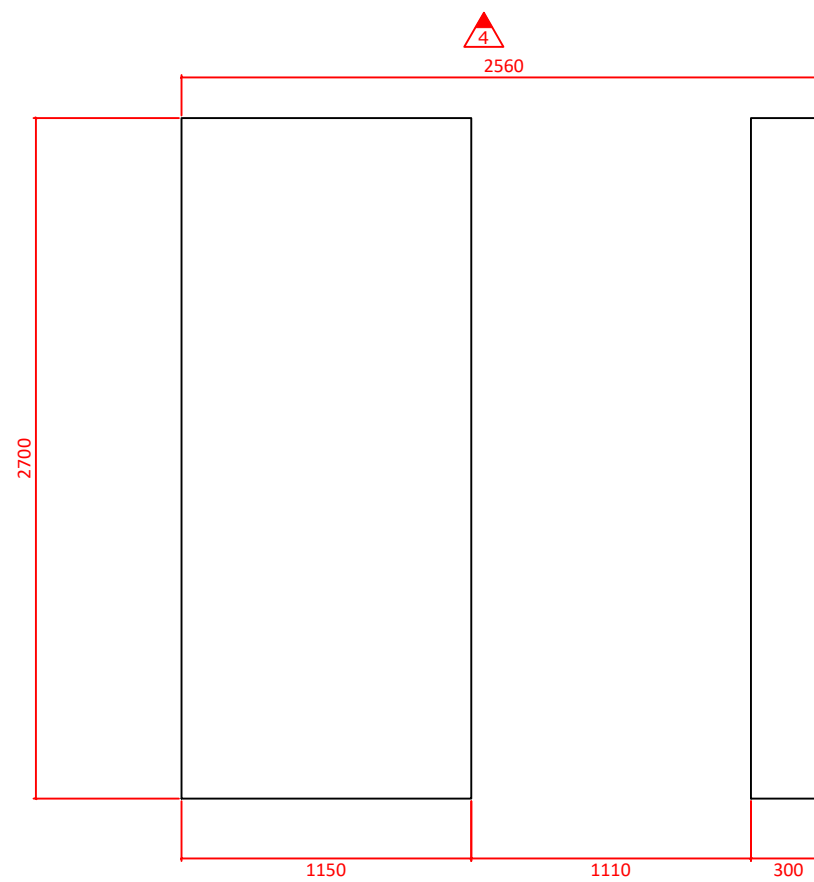
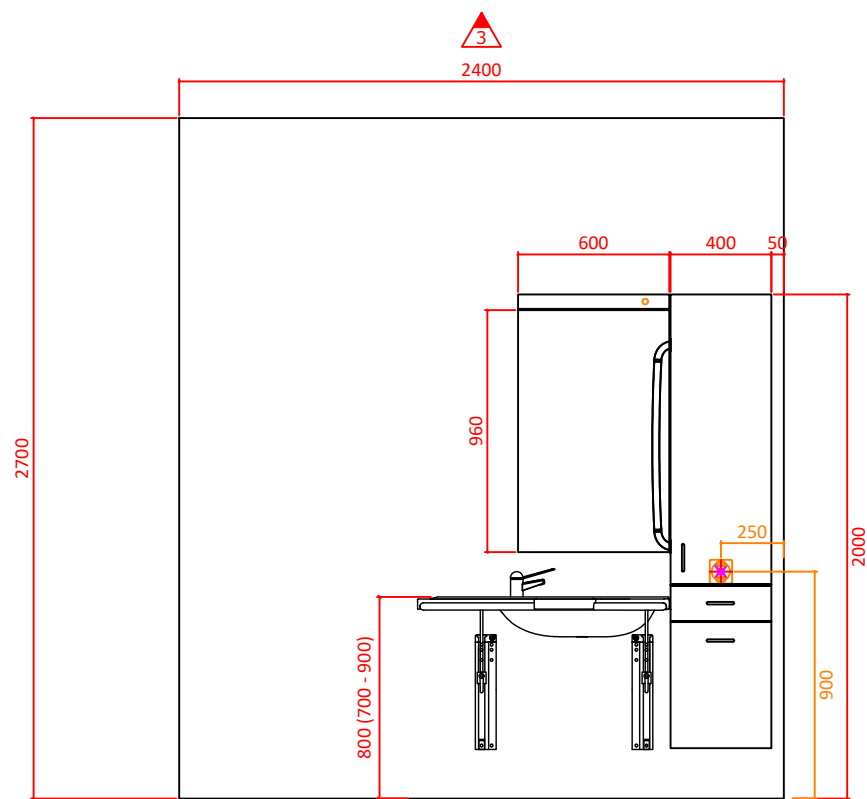
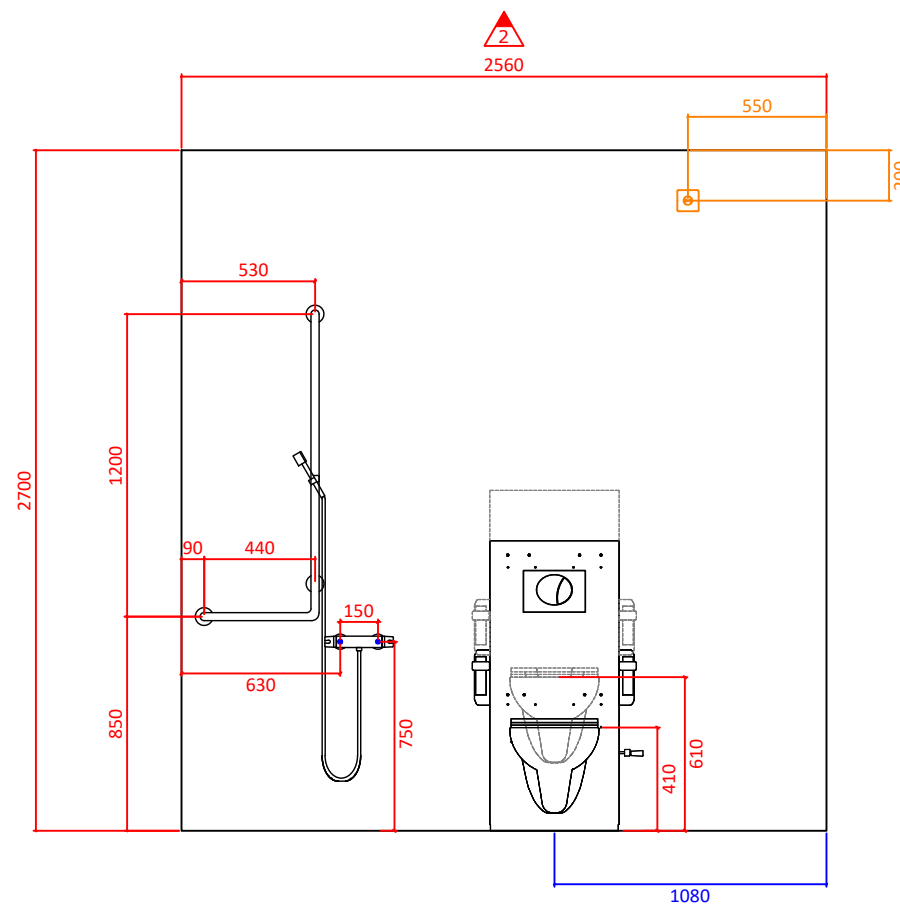
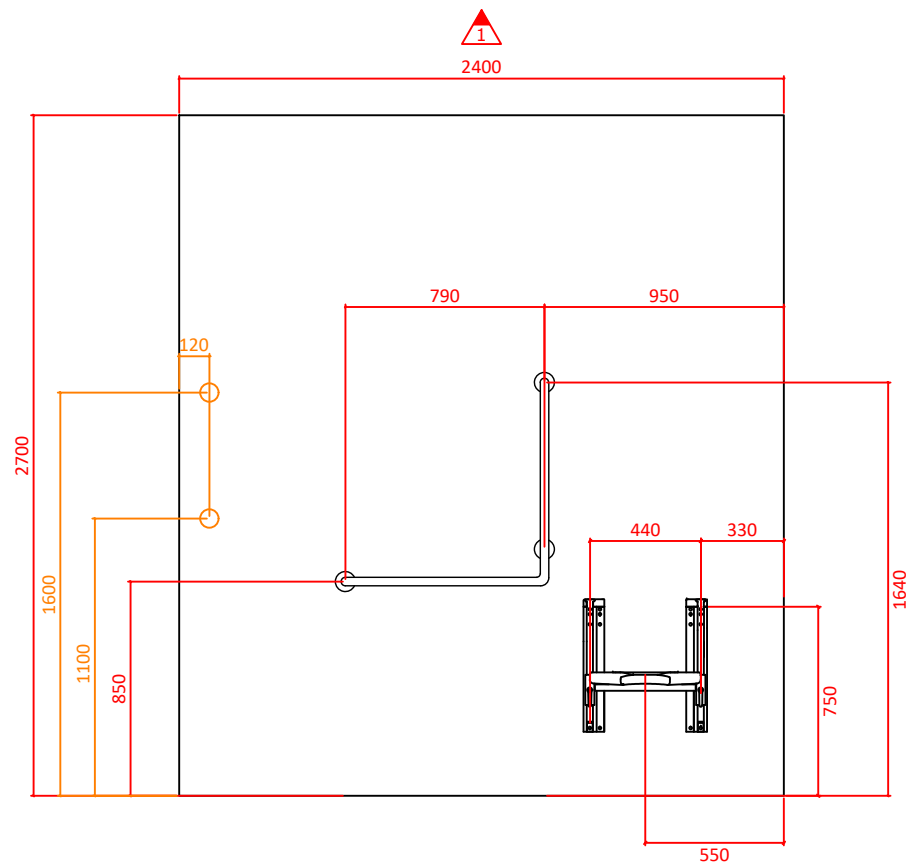

Notes:
1.

5391 Bjerkreim Helsesenter

Equipment - Type 3

Internal height 270 cm	Complete cabin weight ca. 4500 kg	Revision 0	External m ² 6,60 m ²	Internal m ² 6,14 m ²
Date 11.10.2023	Side 1/1	Scale 1:30	Fremtidens badrom	
Drawn by Karol Siedlecki	Signature			

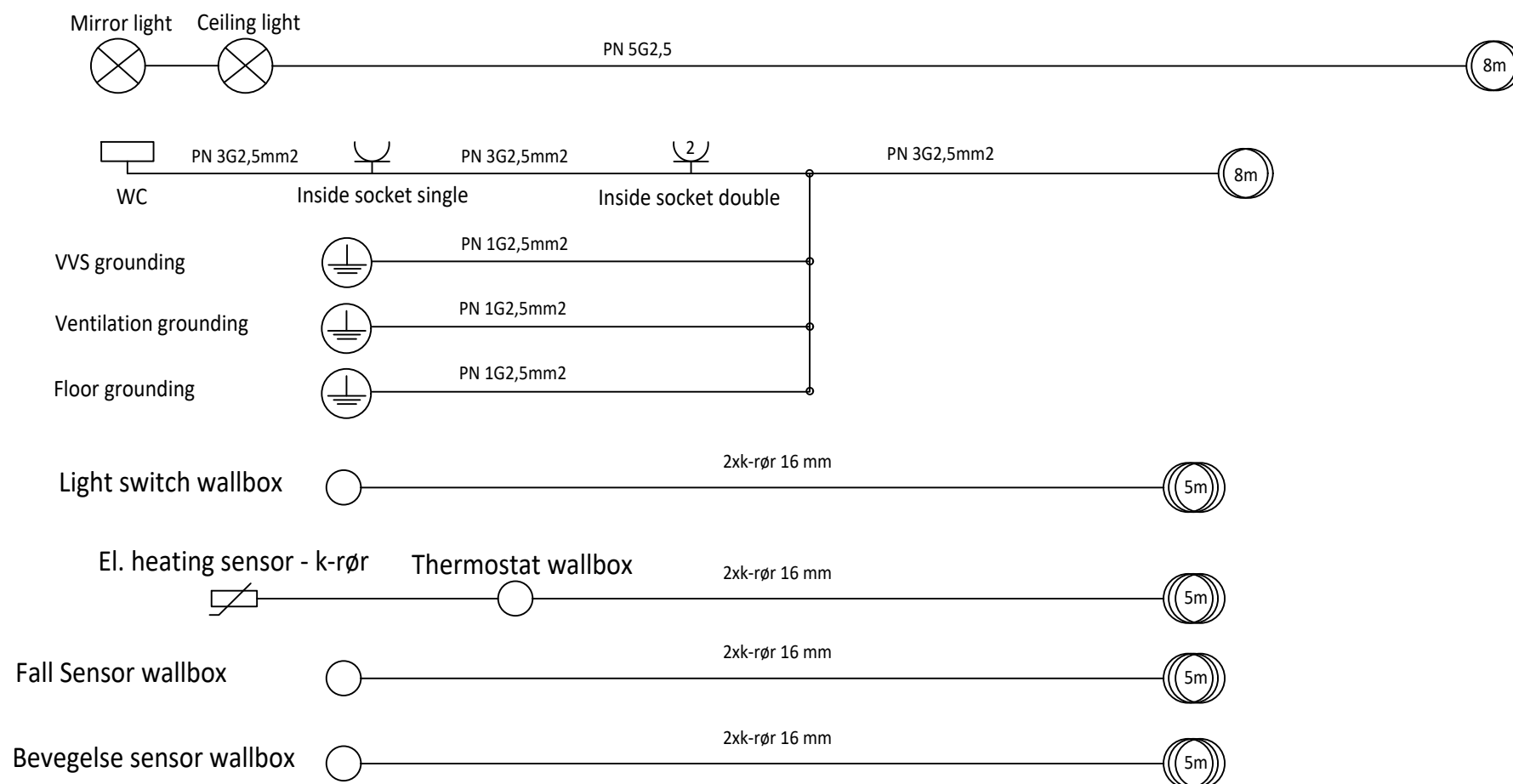

Notice:

1. Placement of opprulls - door wall.

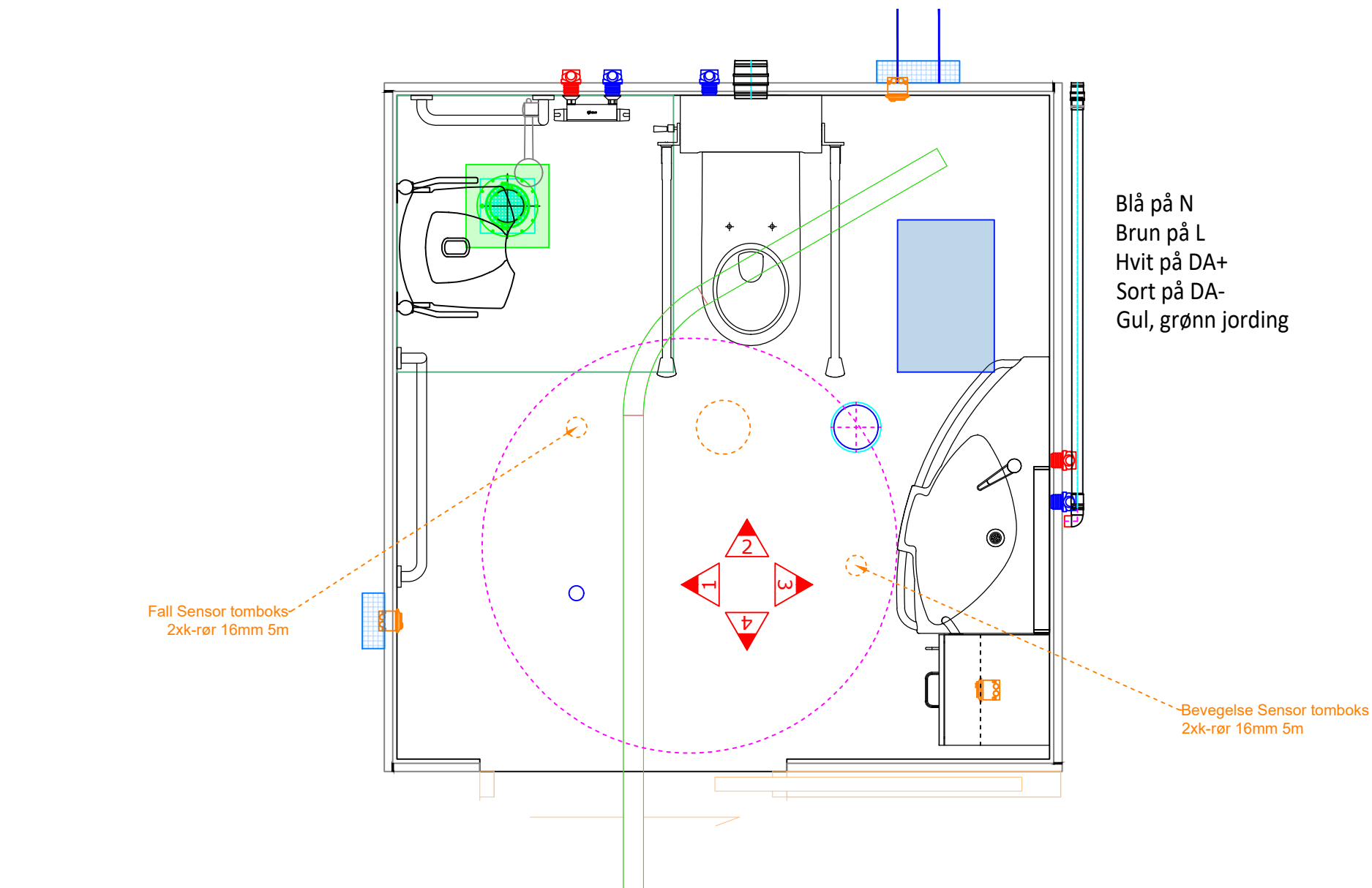
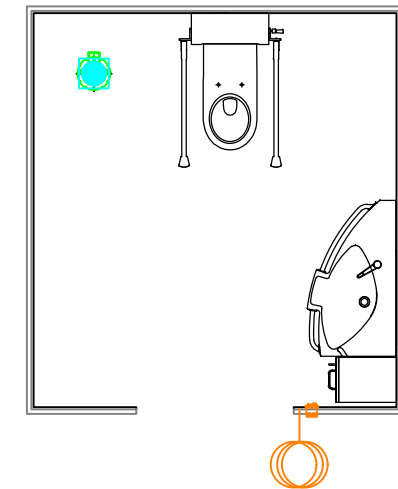

Notes

5391 Bjerkreim Helsesenter

El.Scheme - Type 1 & 3

Internal height 270 cm	Complete cabin weight ca. 4300 kg	Revision 0	External m ² 6,10 m ²	Internal m ² 5,66 m ²
Date 11.10.2023	Side 1/1	Scale 1:20	 Fremtidens baderom	
Drawn by Karol Siedlecki	Signature			

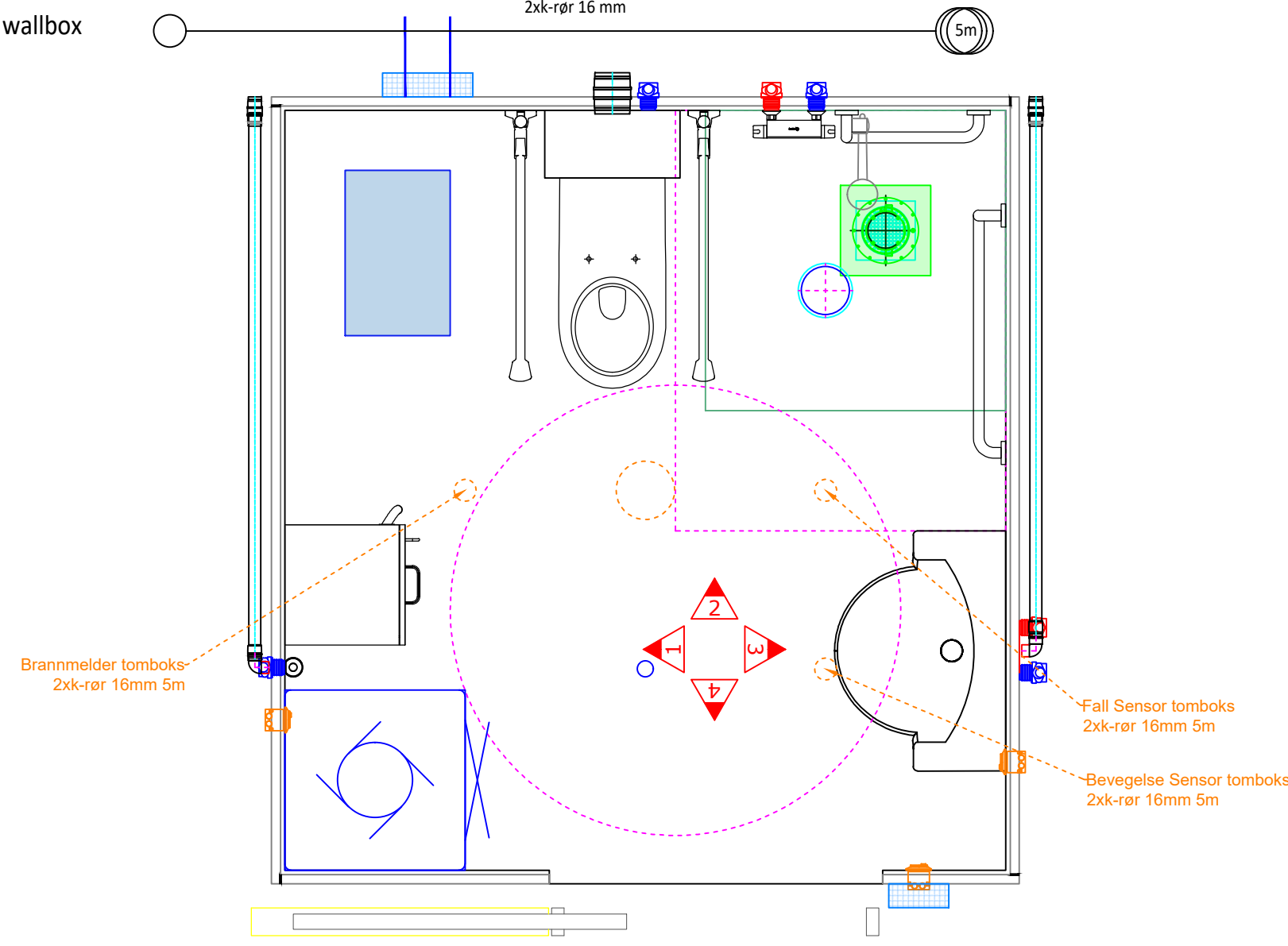
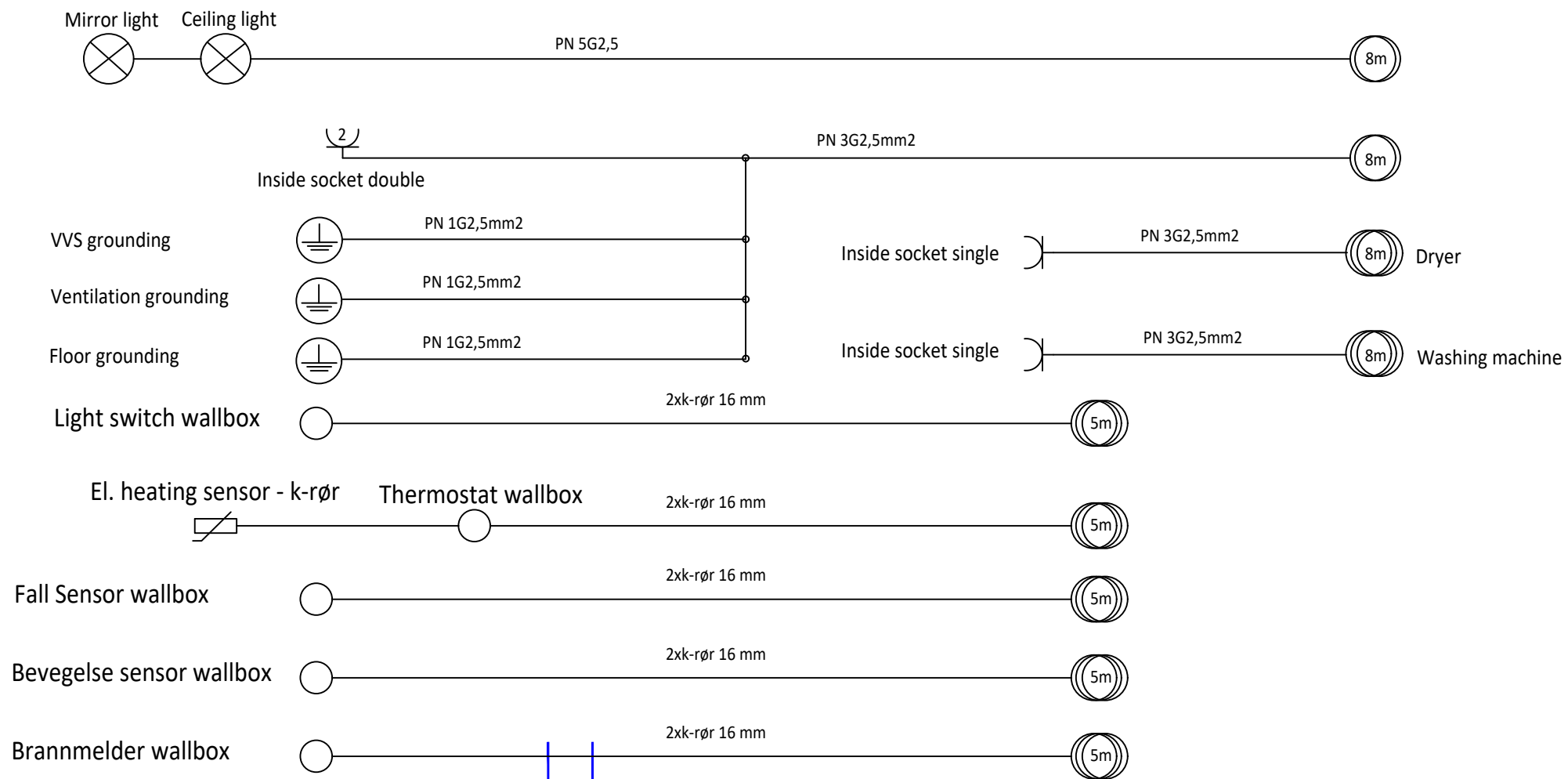

Notice:
1. Placement of opprulls - door wall.

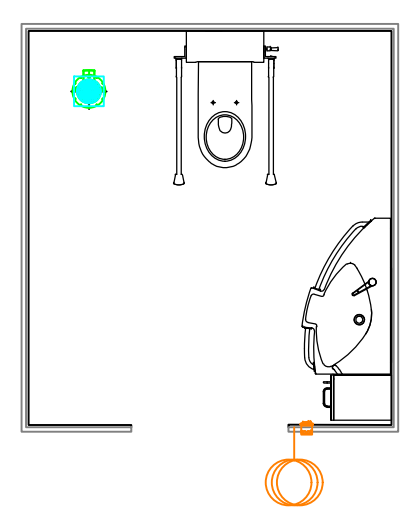

Notes

5391 Bjerkreim Helsesenter

El.Scheme - Type 2

Internal height 270 cm	Complete cabin weight ca. 4500 kg	Revision 0	External m ² 6,52 m ²	Internal m ² 6,07 m ²
Date 11.10.2023	Side 1/1	Scale 1:20		
Drawn by Karol Siedlecki	Signature			