

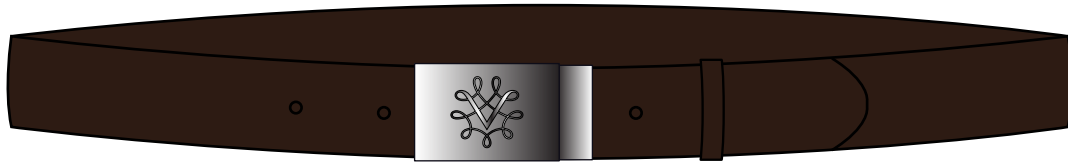

Article description

Leather belt in dark brown leather with engraved logo metal buckle.
Total length 120 cm and 140 cm.



Soft handfeel
Thickness 3.0-3.2 mm
Width 3.0 cm

Size: 100 cm

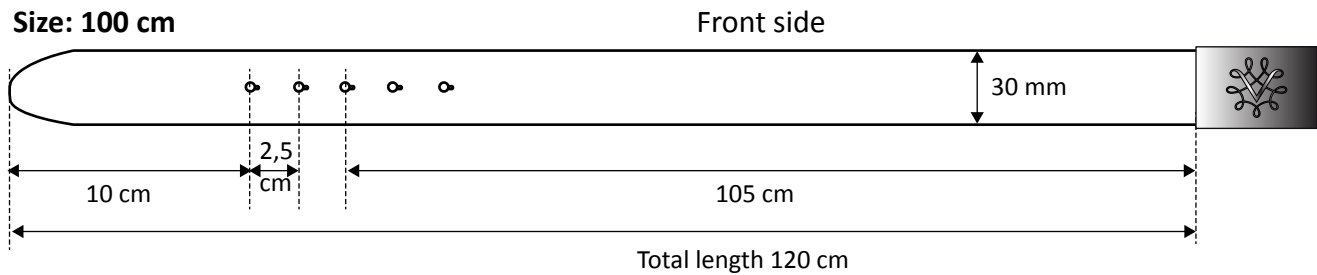

Size: 125 cm

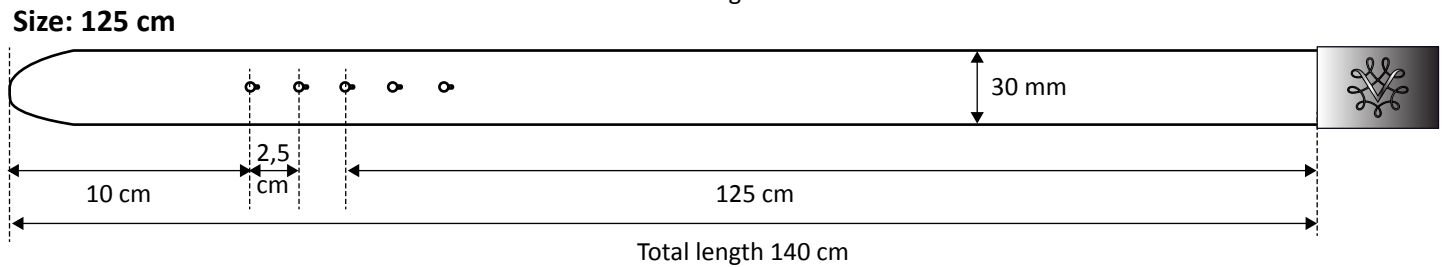

Buckle description

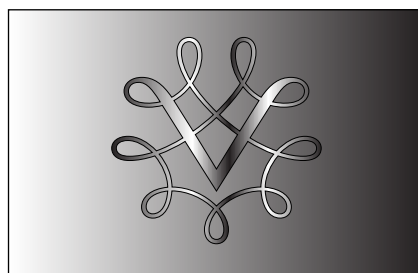
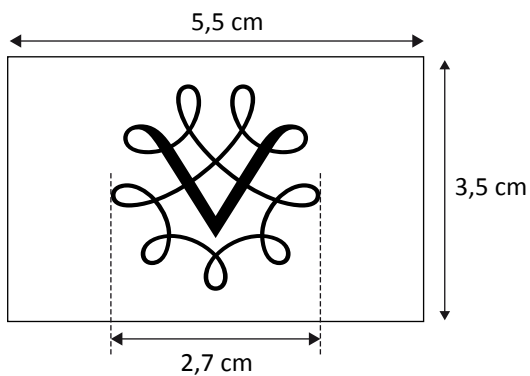

Buckle seen from side

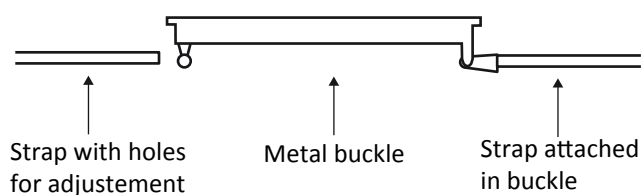

Back side

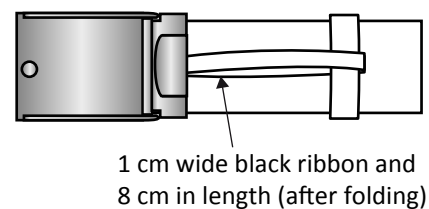

technical specification
Vinmonopolet
model. belt
art no. 5400411



AS VINMONOPOLET

2021-09-01

Material specification:

Leather quality:	Full grain single layer Mousse leather
Leather colour:	Dark brown
Tanning:	Vegetable
Leather thickness and width:	3,0-3,2 mm, 30 mm wide
Buckle with plate:	Metal

Quality requirements result:

Test	Test method	Min. requirement
Colour fastness to rubbing	EN ISO 11640	Dry 4 Wet 3-4



Print artwork

Back print in colour white
Artwork in 1:1 scale

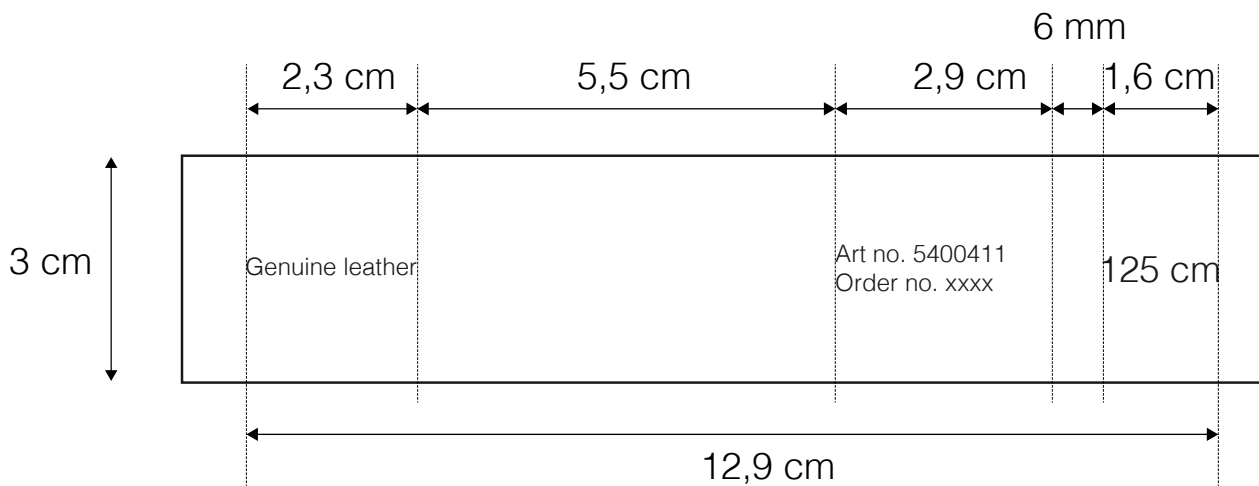
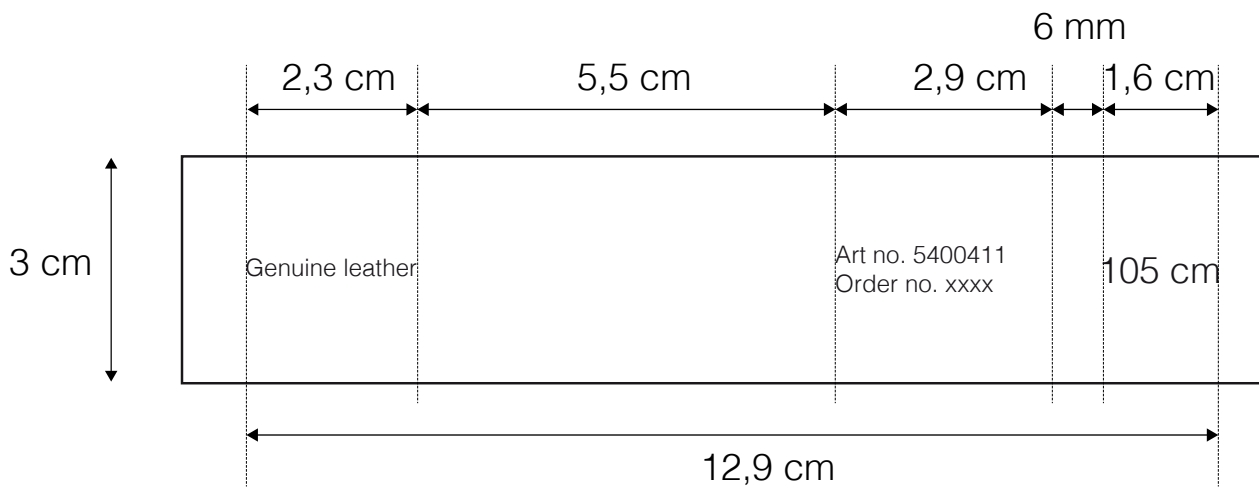

Principle for folding (adjust when necessary)

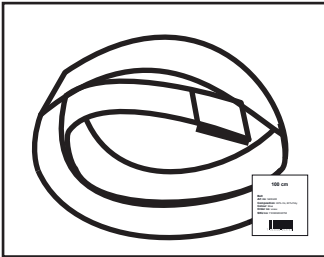

Paper sticker for poly bag

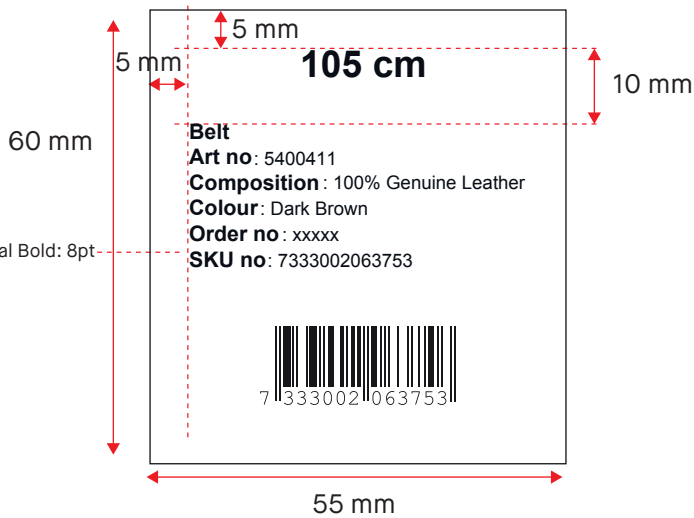

Placement on poly bag

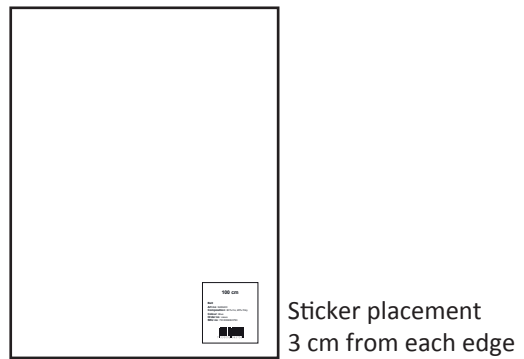

Kindly fill in the correct information for size, model, article no, colour no and order no.
 Please send an artwork of all labels for approval before printing.

Carton print

Use 5 ply automatic corugated cartons
 size 20 x 30 cm

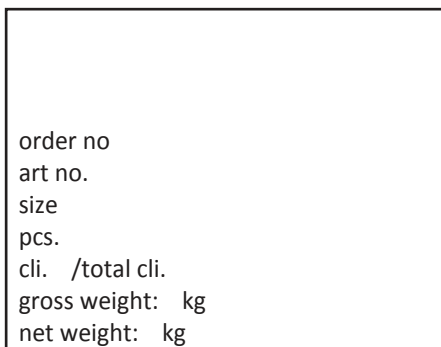

Carton size

size 60 x 40 x 40 cm (Please adjust the height as per the requirements)

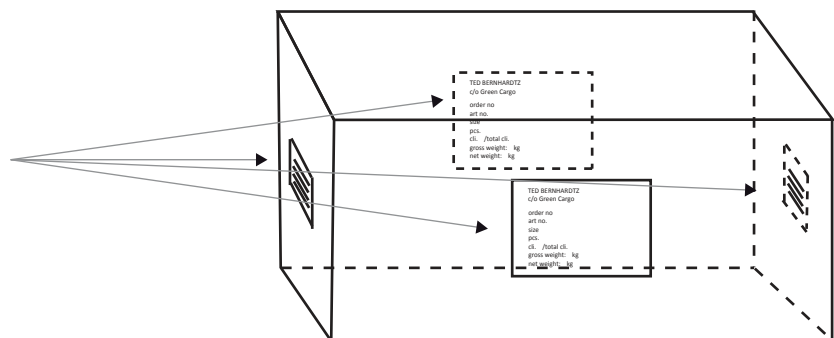

Kindly fill in the correct information according to PO.
 Placement on short ends and front of carton.

technical specification
Vinmonopolet
model. belt
art no. 5400411



ÅS VINMONOPOLET

2021-09-01

Adjustment log