

technical specification
Vinmonopole
model. men's cardigan
art no. 5400406



A/S VINMONOPOLET

2021-09-01

Article description

Men's cardigan.

Composition: 50% merino wool, 50% acrylic, Antipilling treated yarn

Construction: Half Milano, 2/32

Colour: Brown melange

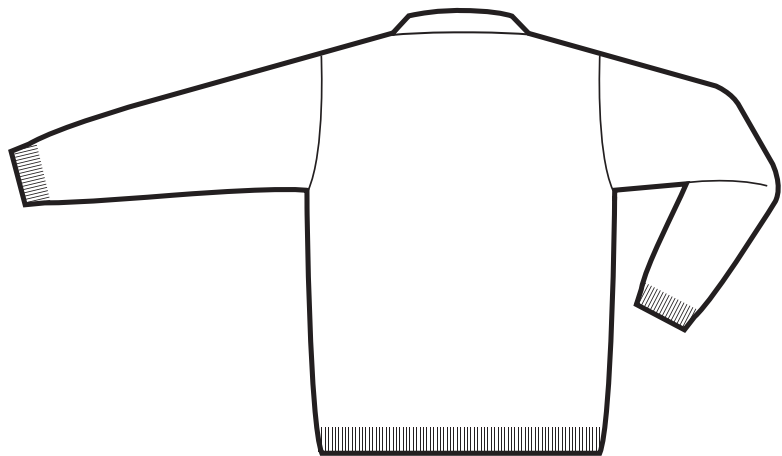
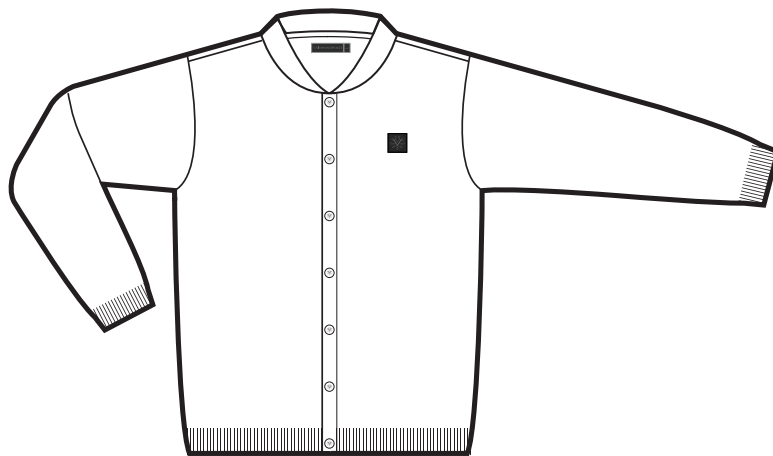

technical specification
Vinmonopole
model. men's cardigan
art no. 5400406



AS VINMONOPOLET

2021-09-01

Material specification

Supplier/Art no:	
Composition:	50% merino wool, 50% acrylic, Antipilling treated yarn
Construction:	Half Milano, 2/32
Gauge:	10 gauge
Colour:	Brown melange
Weight:	570 gm (size M)



Detail sketch

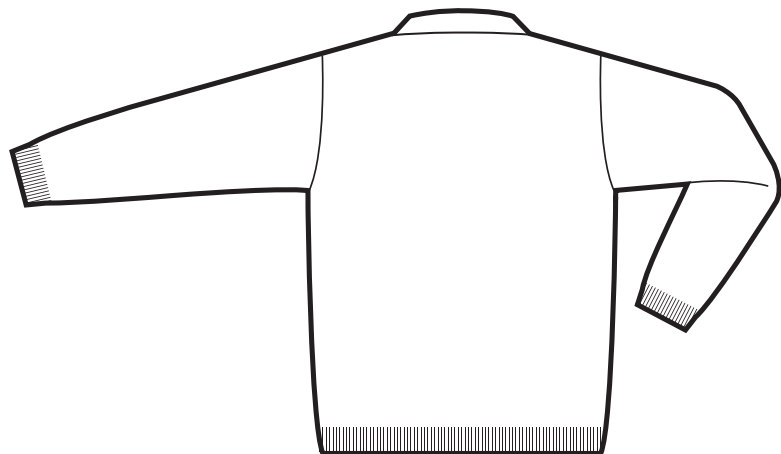
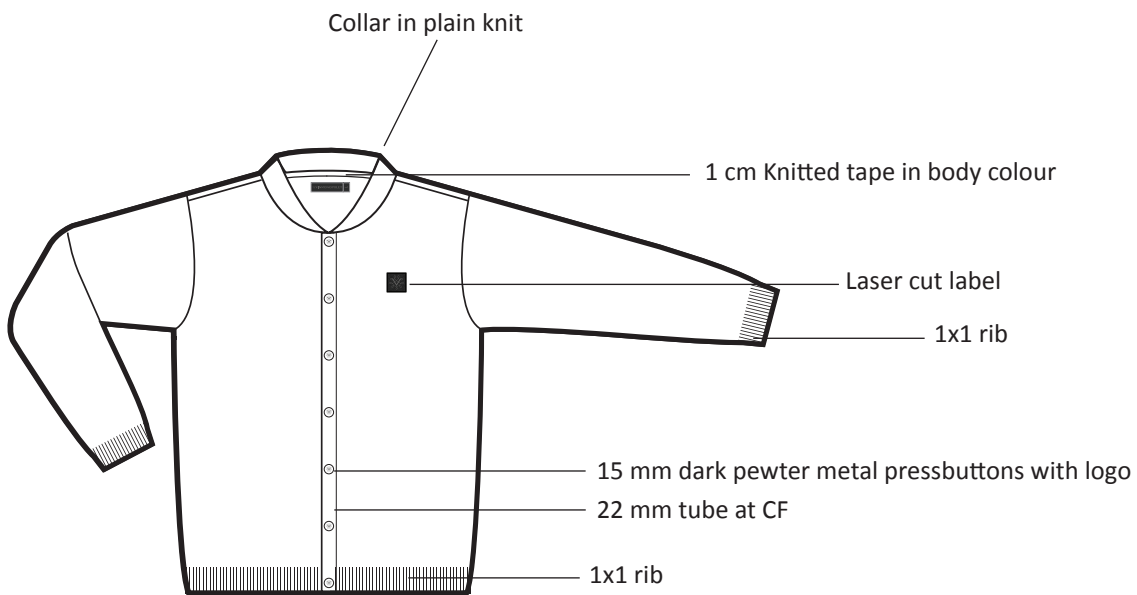



Labels

Main label



Endfolded woven label
Placement inside neck 1 cm below neck
Stitched on both ends only.

Size label

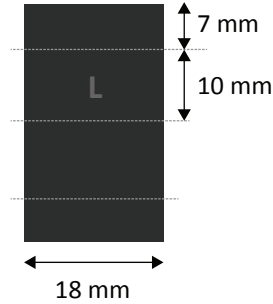

Midfolded woven size label
Placement LHS of main label when wearing.

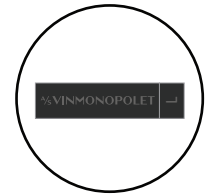

Size label placement

Care label

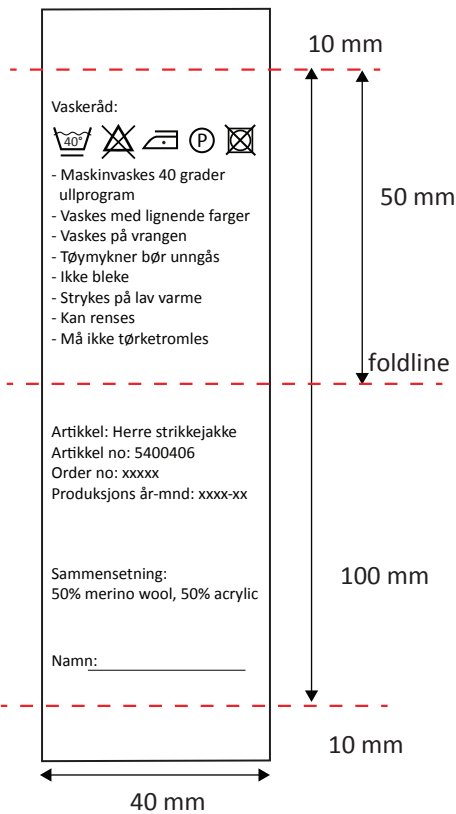

Care label in White background
with black printed text
Quality: Woven Satin
Placement on LHS side seam when wearing,
10 cm from bottom.
Fill in correct info acc to PO.

Laser cut label

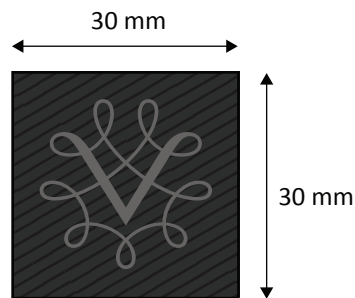

Laser cut label, quality as Bucalo label, stitched all around.
Placement on LHS chest, 21 cm from HPS and
9,5 cm from CF (size L)



BOM

Content	Description	Placement	Qty
Main fabric	50% merino wool, 50% acrylic		
Contrast fabric			
Insert fabric			
Knee lining			
Pocket lining			
Interlining 1			
Interlining 2			
Interlining 3			
Padding			
Rib 1			
Rib 2			
Tape 1	Fishbone tape 20 mm	At inside CF	
Tape 2			
Tape 3			
Piping			
Binding			
Velcro tape 1			
Velcro tape 2			
Elastic			
Reflective tape 1			
Reflective tape 2			
Button 1	15 mm metal pressbutton in dark pewter with logo	At CF placket	7
Button 2			
Button 3			
Zipper tape			
Zipper 1			
Zipper 2			
Zipper 3			
Puller 1			
Puller 2			
Buckle			
D-rings			
Rivets			
Stopper			
Cord			
Hook and eye			
Main label	Woven polyester satin end folded label	At inside 1 cm below neck seam	1
Size label	Woven polyester satin mid folded label	LHS of main label when wearing	1
Flag label			
Logo badge label	Laser cut label	On LHS chest	1
Logo zippuller			
Care label	Printed woven polyester satin label	On LHS in side seam 10 cm fr bottom	1
Hang loop			
Thread 1	100% core spun polyester thread in DTM		
Thread 2			
Thread 3			
Collar bone			



Measurement list

	Men's cardigan	XS	S	M	L	XL	2XL	3XL	4XL	5XL
A.	1/2 Chest	47	51	55	59	63	67	71	75	79
B.	1/2 Waist	44	48	52	56	60	64	68	72	76
C.	1/2 Bottom	41	45	49	53	57	61	65	69	73
D.	Front width 15 cm fr HPS	33	37	41	45	49	53	57	61	65
E.	Back width 15 cm fr HPS	34	38	42	46	50	54	58	62	66
F.	CBL	66	68	70	72	74	76	78	80	82
G.	Shoulder to shoulder	35	39	43	47	51	55	59	63	67
H.	Armhole depth fr CB neck	23,5	24,5	25,5	26,5	27,5	28,5	29,5	30,5	31,5
I.	1/2 Biceps	16	17	18	19	20	21	22	23	24
J.	1/2 Sleeve width 30 cm fr opening	13	14	15	16	17	18	19	20	21
K.	Sleeve length	65	66	67	68	69	70	71	72	73
L.	1/2 Sleeve opening	8,5	9	9,5	10	10,5	11	11,5	12	12,5
M.	Cuff and bottom rib height	5	5	5	5	5	5	5	5	5
N.	Neck width	17	17,5	18	18,5	19	19,5	20	20,5	21
O.	Front neck drop	11,5	12	12,5	13	13,5	14	14,5	15	15,5
P.	Back neck drop	2	2	2	2	2	2	2	2	2
Q.	Neck rib height	3,5	3,5	3,5	3,5	3,5	3,5	3,5	3,5	3,5
R.	Badge placement fr HPS	20,5	20,5	21	21	21,5	21,5	22	22	22,5
S.	Badge placement fr CF	9	9	9,5	9,5	10	10	10,5	10,5	11
	Garment weight				680					

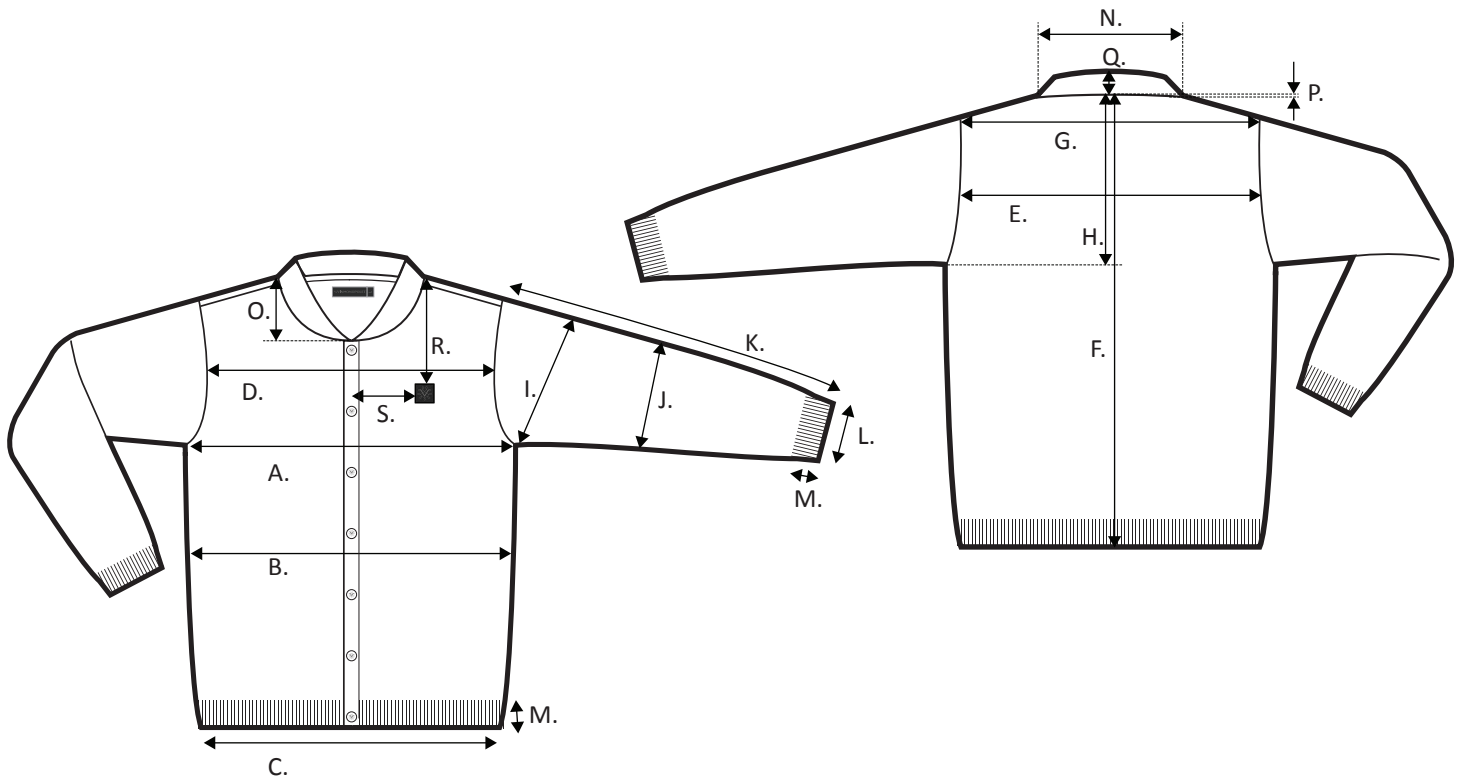



Principle for folding

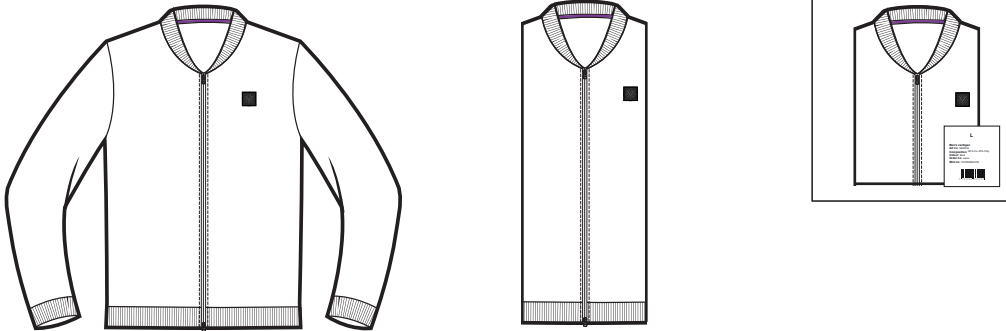

Paper sticker for poly bag

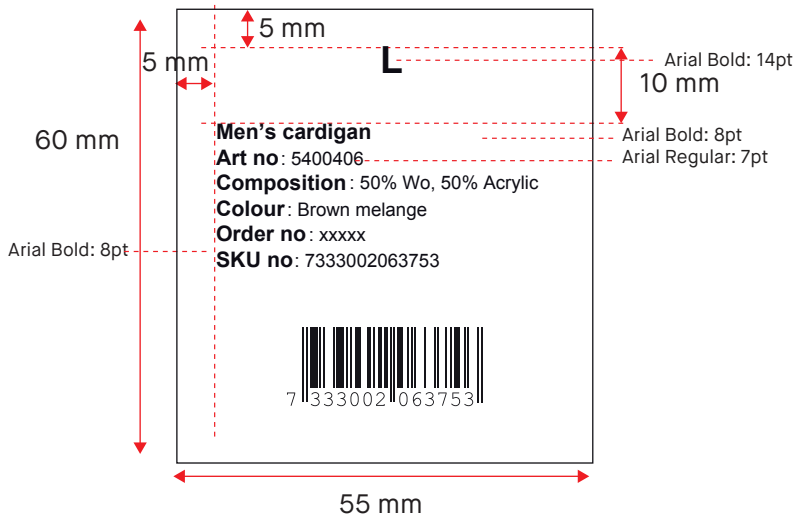

Placement on PE or PP poly bag

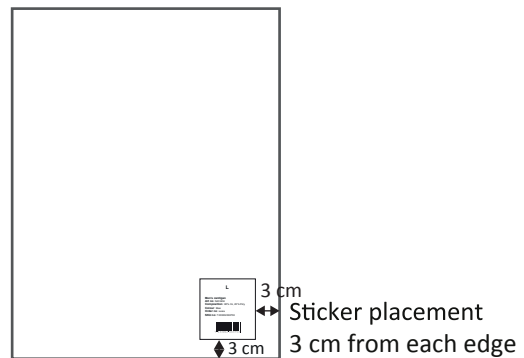

Kindly fill in the correct information for size, model, article no, colour no and order no.
 Please send an artwork of all labels for approval before printing.

Carton print

Use 5 ply automatic corugated cartons
 size 20 x 30 cm

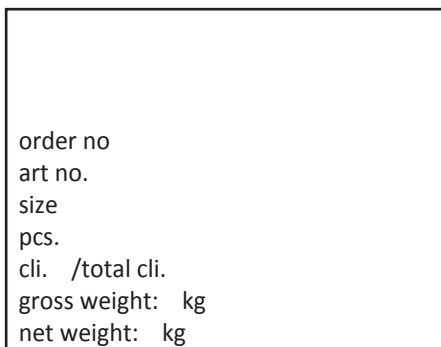

Carton size

size 60 x 40 x 40 cm (Please adjust the height as per the requirements)

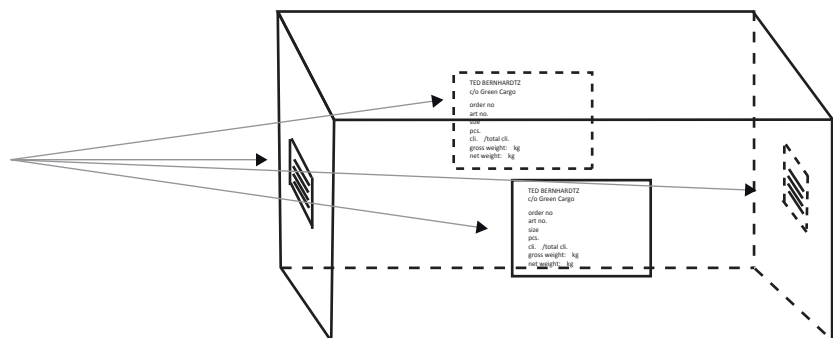

Kindly fill in the correct information according to PO.
 Placement on short ends and front of carton.

technical specification
Vinmonopolet
model. men's cardigan
art no. 5400406



^{AS} VINMONOPOLET

2021-09-01

Adjustment log