

technical specification
Vinmonopolet
model. ladies blouse LS
art no. 5400402



VINMONOPOLET

2021-10-30

Article description

Ladies blouse long sleeve.
Colour: Light blue (Angel falls)



Light blue
(Angel falls)

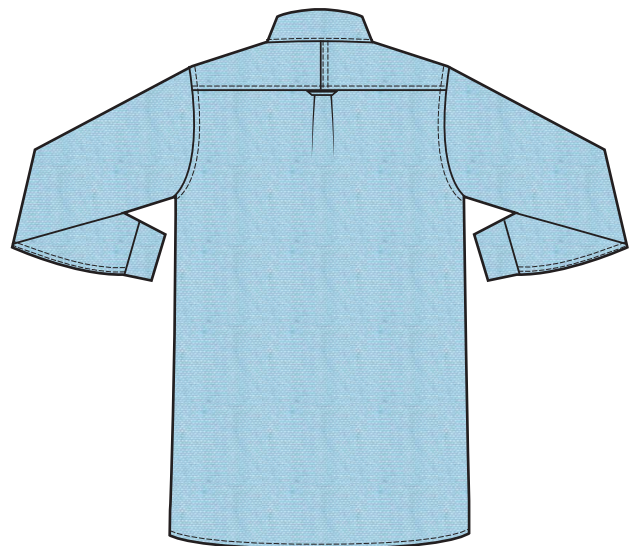



Fabric specification

Supplier/Art no:	
Fabric composition:	80% combed cotton, 20% polyester
Fabric construction:	28x28, 84x68, plain weave
Fabric weight:	135 gsm
Colour:	Light blue (Angel falls)
Finish:	Regular finish

Quality requirements:

Test	Test method	Min. requirement
Dimensional stability to washing	EN ISO 3759, EN ISO 6330, EN ISO 25077, 60°C, Tumble dry	Length: max -2% Width: max -2%
Colour fastness to washing	EN ISO 105-CO6, 60°C	Colour change 4 Colour staining 4
Colour fastness to rubbing	EN ISO 105-X12	Dry: 4 Wet: 3
Pilling Resistance, Martindale	EN ISO 12945-2, 7000 rev.	4
Abrasion Resistance, Martindale	EN ISO 12947-2 12 kPa, rev.	12000
Tear Strength	EN ISO 13937-2:2000, N	Warp: 15 Weft: 15
Tensile strength	EN ISO 13934-1:1999, daN	Warp: 26 Weft: 26
Seam Slippage, mm	EN ISO 13936-2	Warp: max 3 Weft: max 3
Certified according to Öko-Tex standard 100		YES



Detail sketch

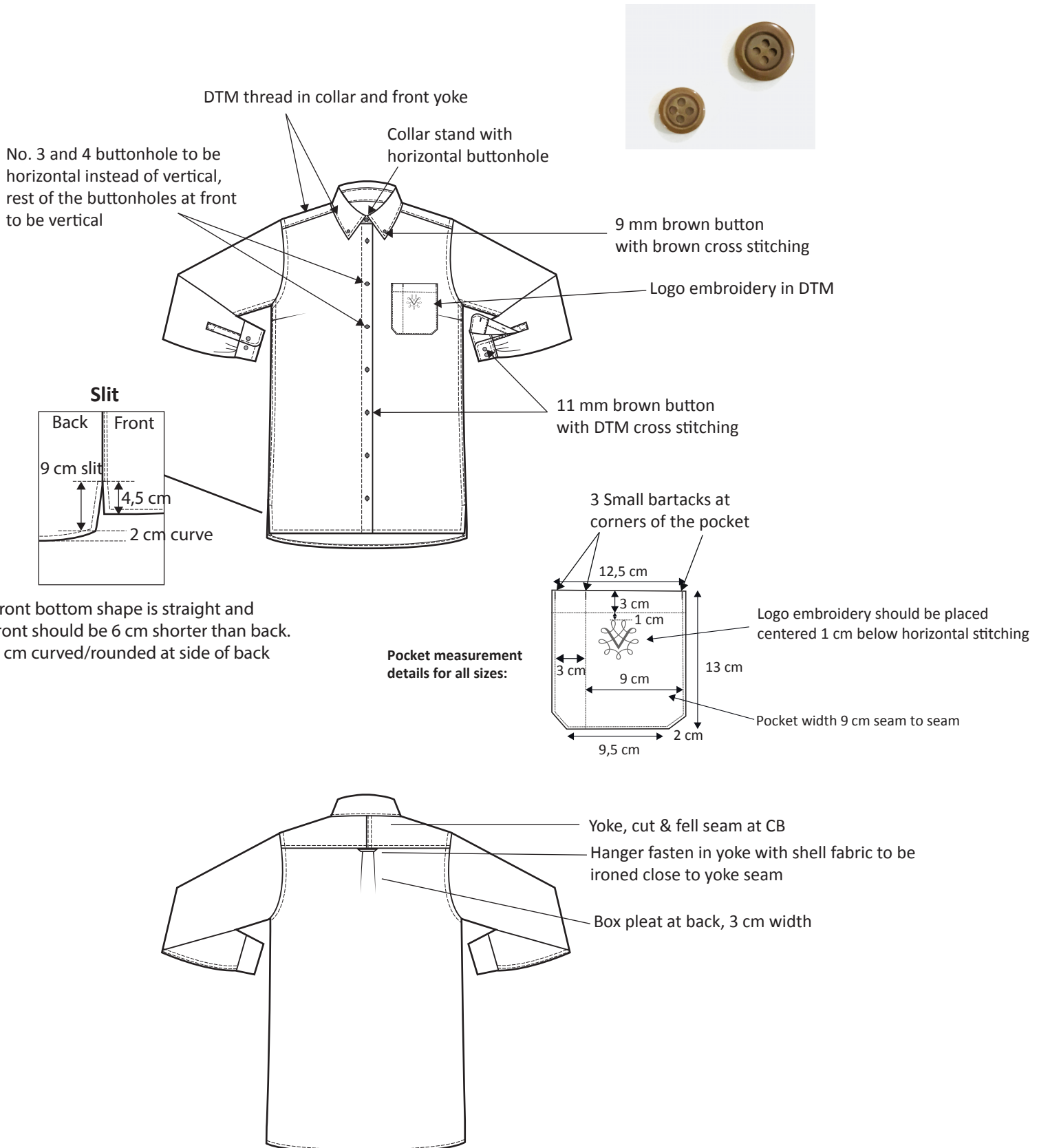



Labels

Main label



Endfolded woven label
Placement inside neck 1 cm below neck
Stitched on short ends only.

Size label

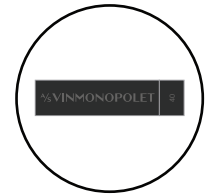
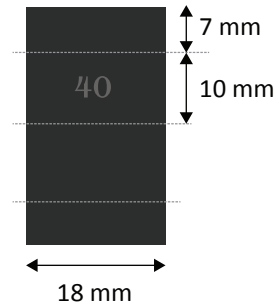

Size label placement

Midfolded woven size label
Placement LHS of main label when wearing.

Care label

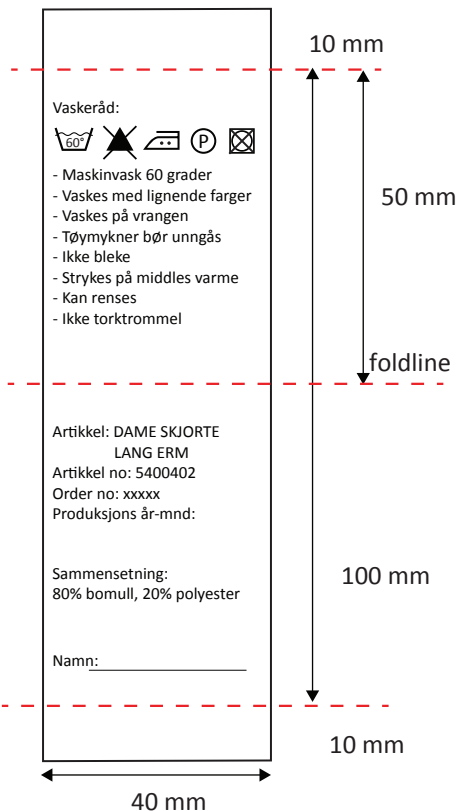

Care label in White background
with black printed text
Quality: Woven Satin
Placement on LHS side seam when wearing,
10 cm from bottom.
Fill in correct info acc to PO.
Extra buttons attached on care label.

Logo Embroidery:

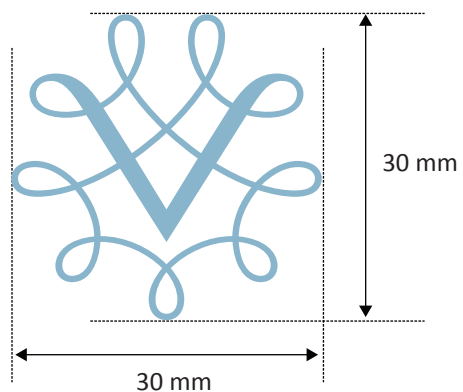

Logo embroidery in DTM colour,
should be placed centered 1 cm below
horizontal stitching (for all sizes).



BOM

Content	Description	Placement	Qty
Main fabric	80% combed cotton, 20% polyester		
Contrast fabric			
Insert fabric			
Lining			
Pocket lining			
Interlining 1	Woven fusible 100% cotton interlining, 140 gsm	Collar	
Interlining 2	Woven fusible 100% cotton interlining, 90 gsm	Collar stand and cuffs	
Interlining 3			
Padding			
Rib 1			
Rib 2			
Tape 1			
Tape 2			
Tape 3			
Piping			
Binding			
Velcro tape 1			
Velcro tape 2			
Elastic			
Reflective tape 1			
Reflective tape 2			
Button 1	11 mm brown button	Front placket and sleeve cuff	8+4
Button 2	9 mm brown button	At collar	2
Button 3	Extra buttons (each sizes 11 mm+ 9 mm)	At care label	1+1
Zipper tape			
Zipper 1			
Zipper 2			
Zipper 3			
Puller 1			
Puller 2			
Buckle			
D-rings			
Rivets			
Stopper			
Cord			
Hook and eye			
Main label	End folded woven label	At inside CB neck	1
Size label	Woven mid folded label	LHS of main label	1
Flag label			
Logo badge label			
Logo zippuller			
Care label	Printed woven polyester satin label	On LHS in side seam 10 cm fr bottom	1
Hang loop			
Thread 1	100% core spun polyester thread in DTM	All seams	
Thread 2	100% core spun polyester thread in Brown	Button cross stitching	
Thread 3			
Collar bone			



Measurement list

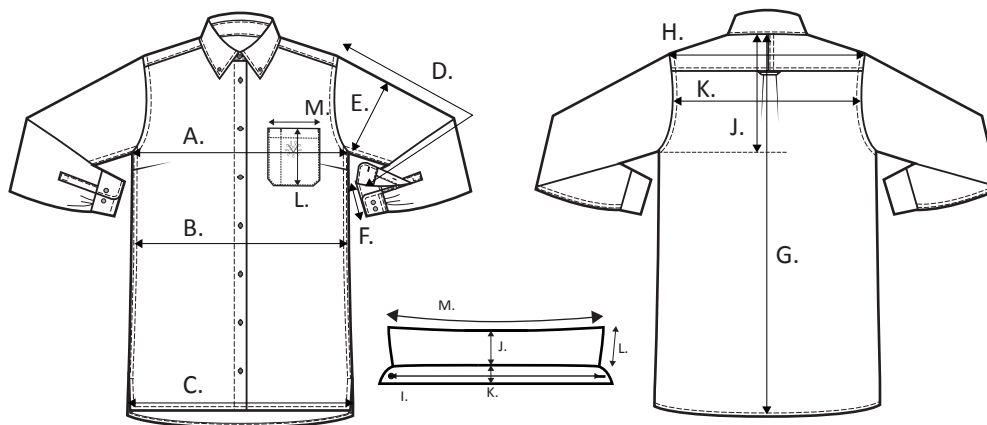

		32	34	36	38	40	42	44	46	48	50	52	54	56
H	Cross shoulder	38	39	40	41	42	43	44	45	46	47	48	49	50
K	Cross back, 15 cm fr CB neck	37	38	39	40	41	42	43	44	45	46	47	48	49
A	Chest, at armhole	91	95	99	103	107	111	115	119	125	131	137	143	149
B	Waist	84	88	92	96	100	104	108	112	118	124	130	136	142
C	Bottom width	95	99	103	107	111	115	119	123	129	135	141	147	153
G	Center Back length	68	69	70	71	72	73	74	75	76	77	78	79	80
	Neckwidth - seam to seam	13,3	13,7	14,1	14,5	14,9	15,3	15,7	16,1	16,5	16,9	17,3	17,7	18,1
	Back neckdrop- HPS to seam	1	1	1	1	1	1	1	1	1	1	1	1	1
	Front neckdrop- HPS to seam	9,4	9,6	9,8	10	10,2	10,4	10,6	10,8	11	11,2	11,4	11,6	11,8
I.	Collar length CF-CF	37	38	39	40	41	42	43	44	45	46	47	48	49
J.	Collar height at CB	4,5	4,5	4,5	4,5	4,5	4,5	4,5	4,5	4,5	4,5	4,5	4,5	4,5
K.	Collar stand height- at CB	3	3	3	3	3	3	3	3	3	3	3	3	3
L.	Collar point length- seam to edge	5,5	5,5	5,5	5,5	5,5	5,5	5,5	5,5	5,5	5,5	5,5	5,5	5,5
M.	Collar width- flat collar outer edge	37,5	38,5	39,5	40,5	41,5	42,5	43,5	44,5	45,5	46,5	47,5	48,5	49,5
	Placket width	3	3	3	3	3	3	3	3	3	3	3	3	3
	Bk yoke Plcmt-straight below CB Nk	9	9	9	9	9	9	9	9	9	9	9	9	9
	Fr yoke Plcmt-meas along neckline fr	3,5	3,5	3,5	3,5	3,5	3,5	3,5	3,5	3,5	3,5	3,5	3,5	3,5
	1/2 armhole at front	18,6	19,4	20,2	21	21,8	22,6	23,4	24,2	25	25,8	26,6	27,4	28,2
D	Sleeve length	60	61	62	63	64	65	66	67	68	68	68	68	68
E	Bicep	34,5	36	37,5	39	40,5	42	43,5	45	47	49	51	53	55
	Elbow placment, fr cuff	30	30	30	30	30	30	30	30	30	30	30	30	30
	Elbow width	27,5	29	30,5	32	33,5	35	36,5	38	39,5	41	42,5	44	45,5
	Cuff height	6,5	6,5	6,5	6,5	6,5	6,5	6,5	6,5	6,5	6,5	6,5	6,5	6,5
F	Cuff width, widest buttoning	18	19	20	21	22	23	24	25	26	27	28	29	30
F	Cuff width, tightest buttoning	16	17	18	19	20	21	22	23	24	25	26	27	28
	Sleeve placket length	13,2	13,2	13,2	13,2	13,2	13,2	13,2	13,2	13,2	13,2	13,2	13,2	13,2
	Sleeve placket opening	10	10	10	10	10	10	10	10	10	10	10	10	10
	Sleeve placket width	1,5	1,5	1,5	1,5	1,5	1,5	1,5	1,5	1,5	1,5	1,5	1,5	1,5
	Curve difference between bottom ar	5	5	5	5	5	5	5	5	5	5	5	5	5
	Button distance 1st and 2nd	5	5	5	5	5	5	5	5	5	5	5	5	5
	Button distance centre to centre	7,5	7,5	7,5	7,5	7,5	7,75	8	8	8	8	8	8	8
	Bust dart 5 cm from armpit													
	Bust dart length				8									
	Bust dart depth				1,5									



Packing instructions

Principles for folding and packing

Folding and packing like Eton sample. With shaped cardboard, folded with pins and packed in cellophane bag.

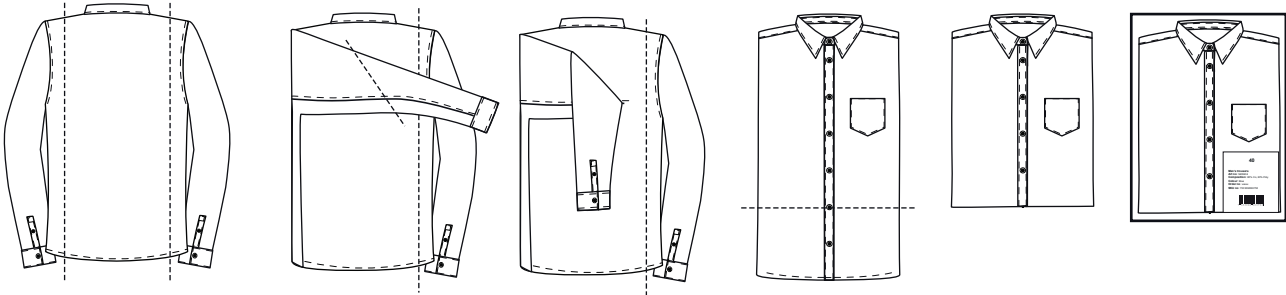

Paper sticker for poly bag

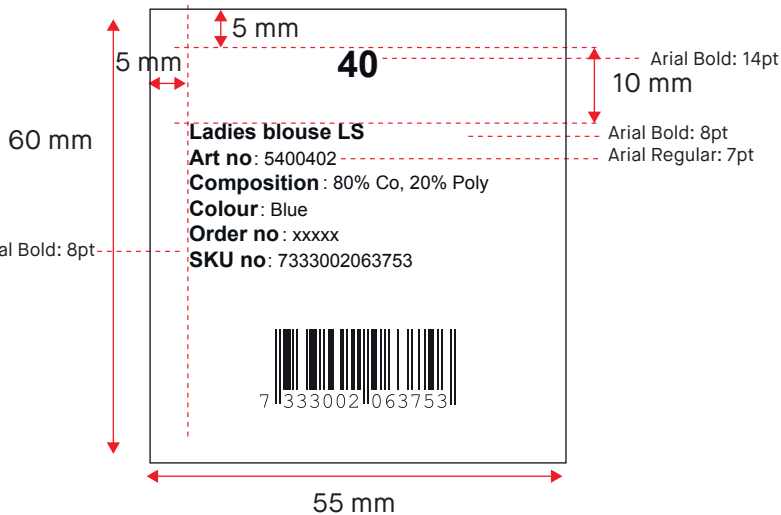

Placement on PE or PP poly bag

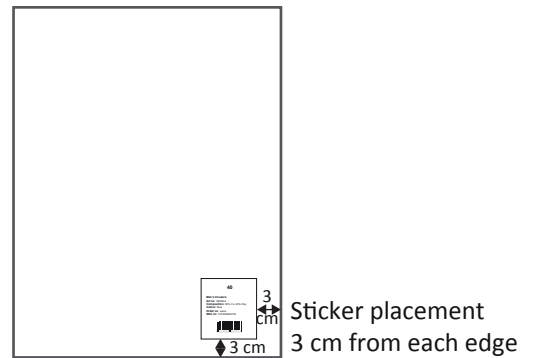

Kindly fill in the correct information for size, model, article no, colour no and order no.
 Please send an artwork of all labels for approval before printing.

Carton marks

Use 5 ply automatic corrugated cartons
 size 20 x 30 cm

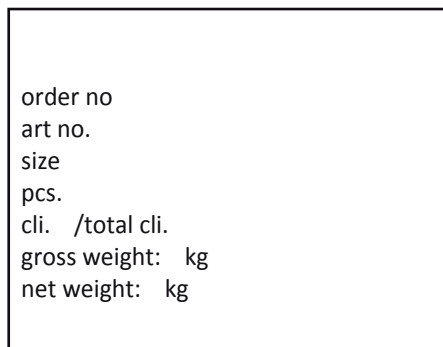

Carton size

size 40 x 60 x 40 cm

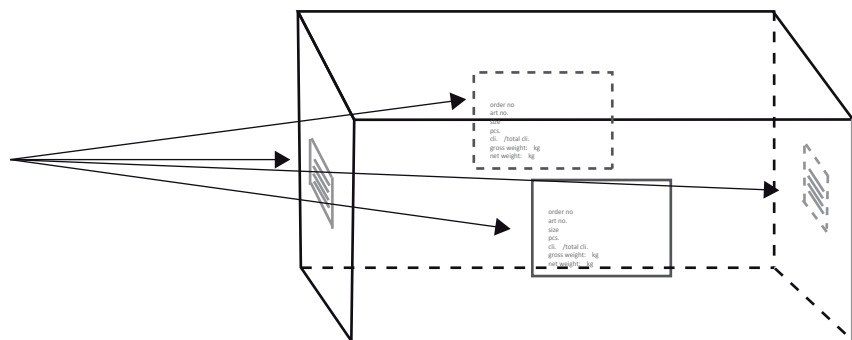

Kindly fill in the correct information according to PO.
 Placement on short ends and front of carton.

technical specification
Vinmonopolet
model. ladies blouse LS
art no. 5400402



ÅS VINMONOPOLET

2021-10-30

Adjustment log