

PLAN KANAL FOR STRØMSKINNER - DEL 1  
1 : 50

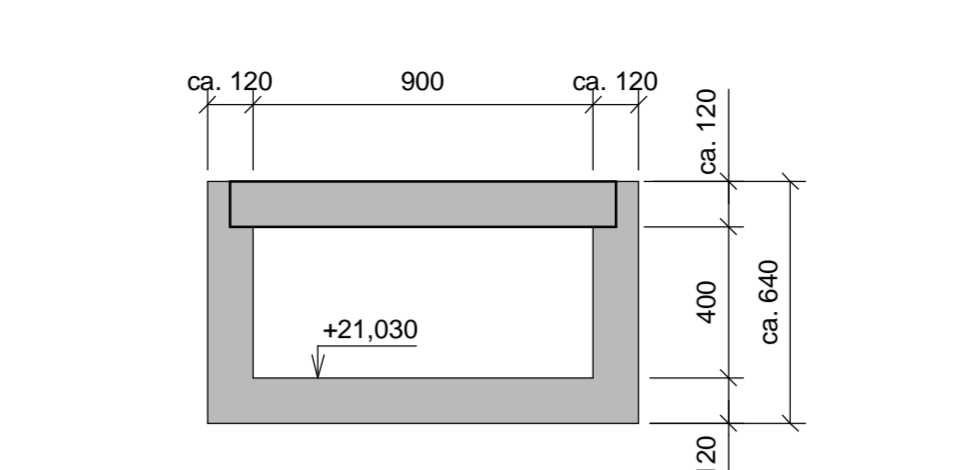

SNITT 1  
1 : 20

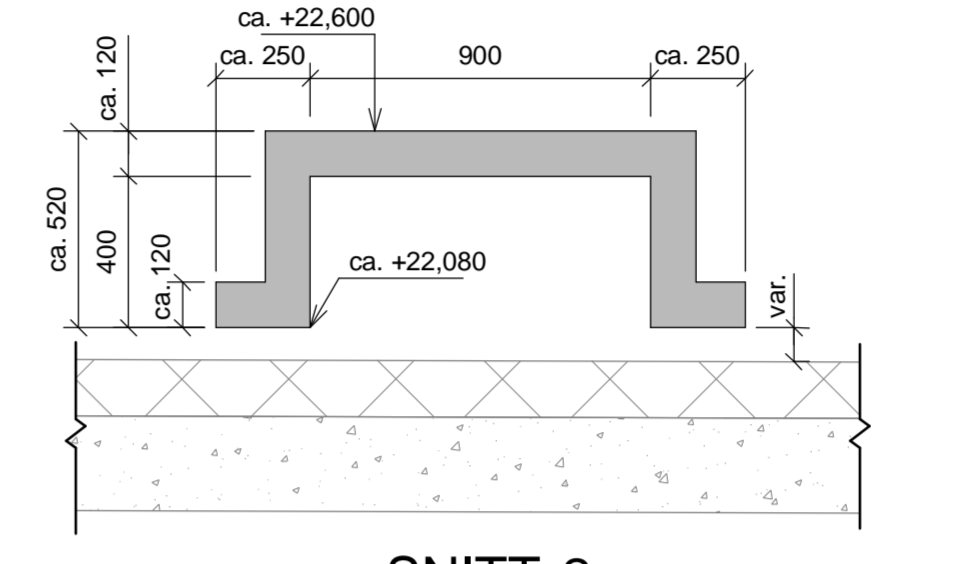

SNITT 2  
1 : 20

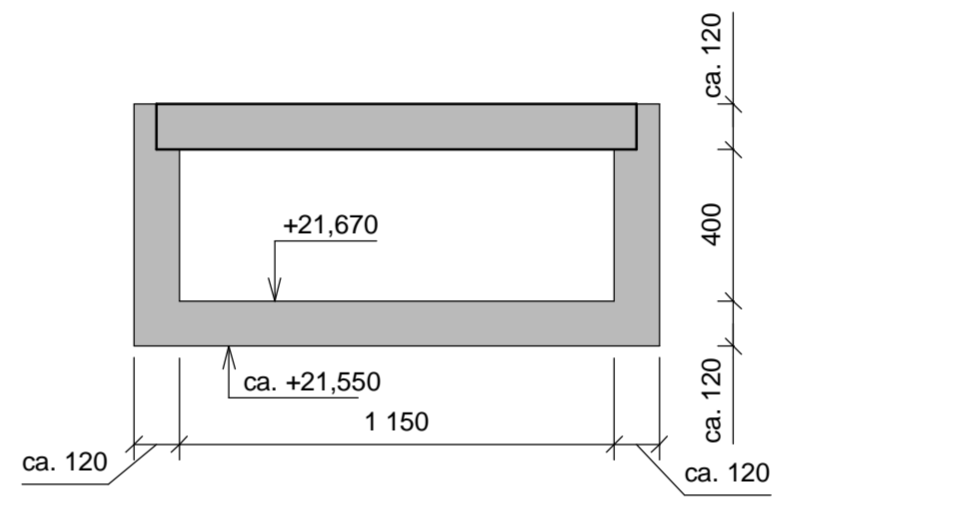

SNITT 3  
1 : 20

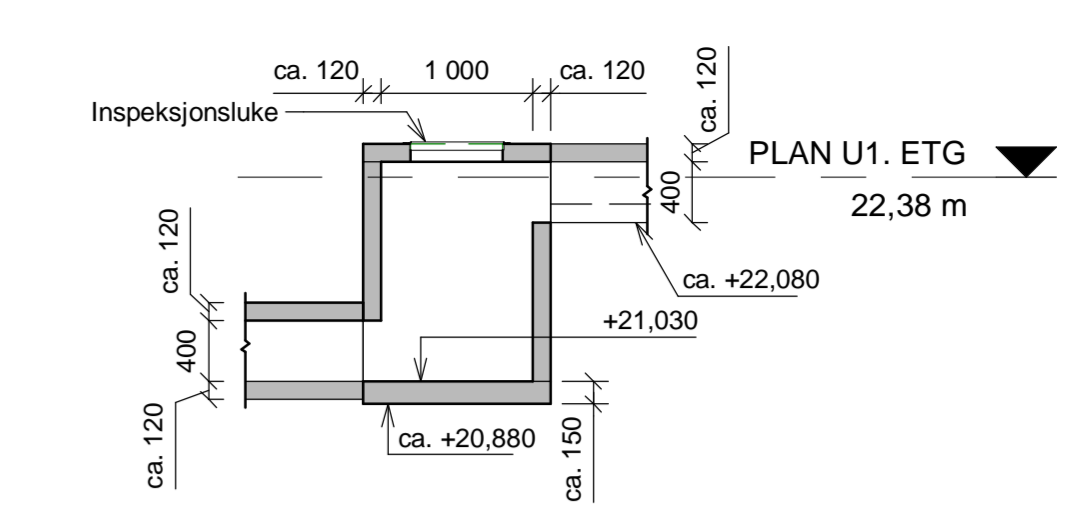

SNITT A  
1 : 50

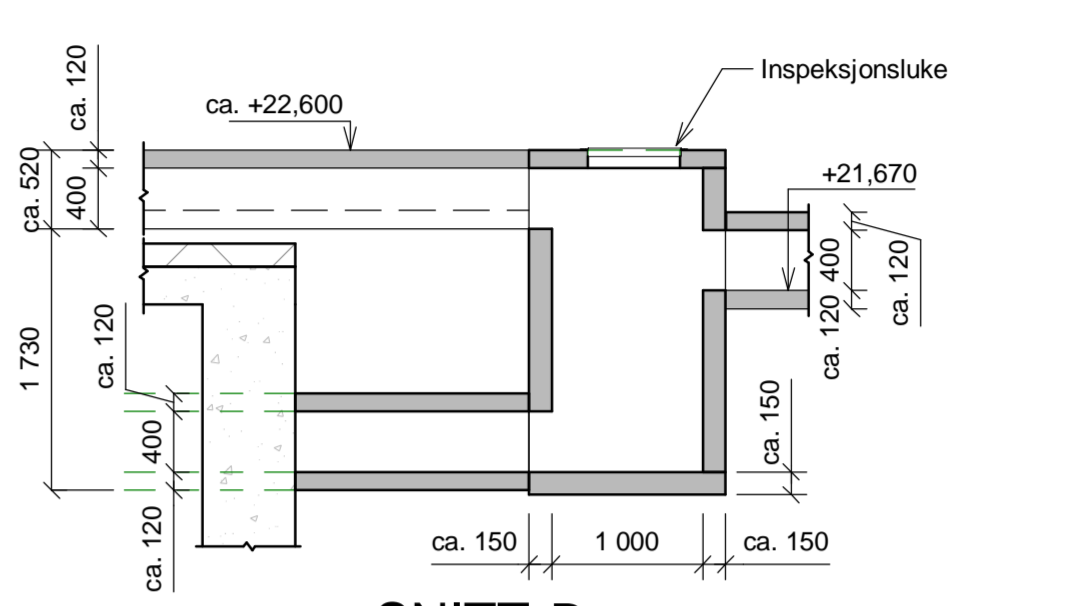

SNITT B  
1 : 50

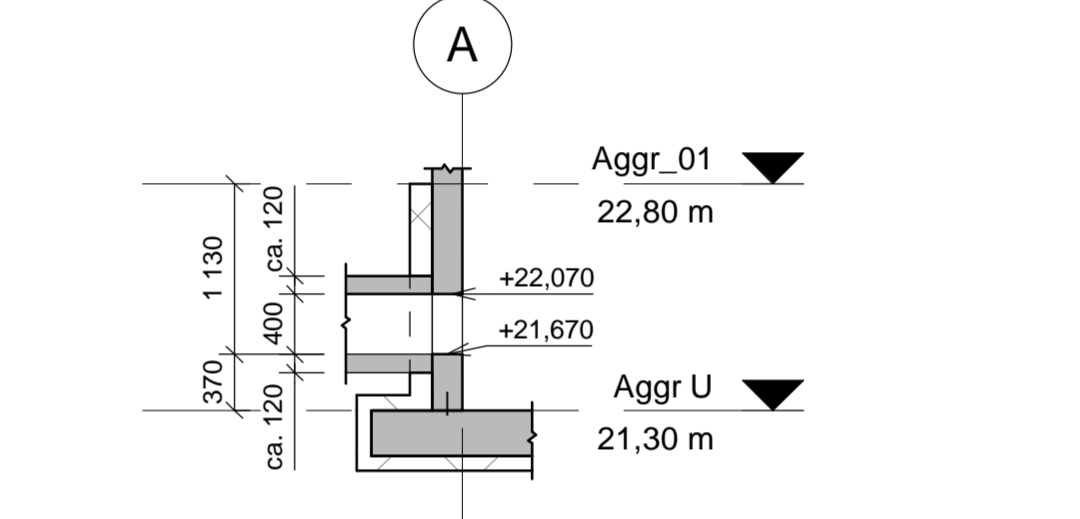

SNITT C  
1 : 50

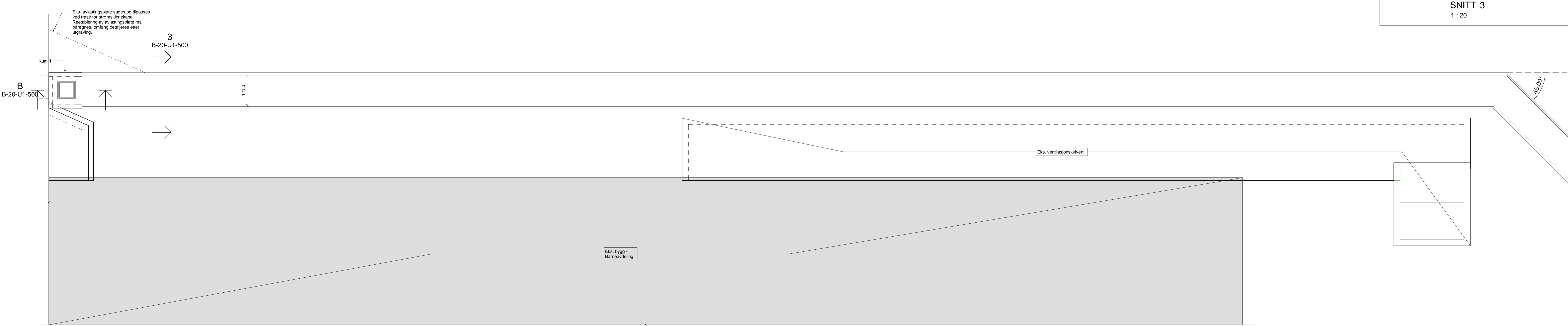

PLAN KANAL FOR STRØMSKINNER - DEL 2  
1 : 50

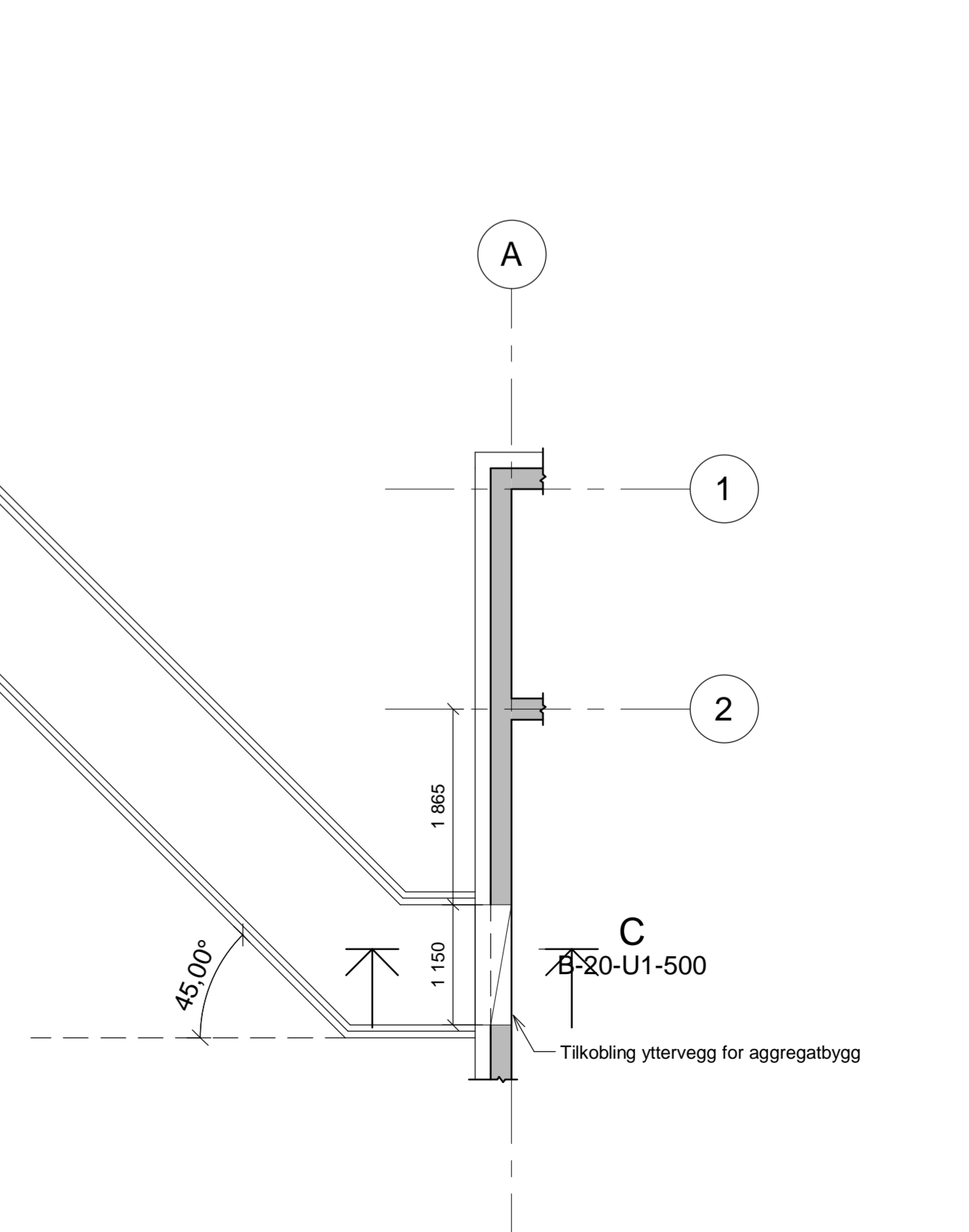

F02	2020-11-02	For anskaffelse	EirAun	SiBru	RoFur
D01	2020-10-21	For gjennomgang hos byggherre	EirAun	SiBru	RoFur
Rev.	Dato	Beskrivelse	Utarbeidet	Fagansvar	Godkjent

Helse Møre og Romsdal HF 1:50/1:20

ÅLESUND SYKEHUS STRØMFORSYNING  
PLAN KANAL FOR STRØMSKINNER