

SF75 - ϕ 1000

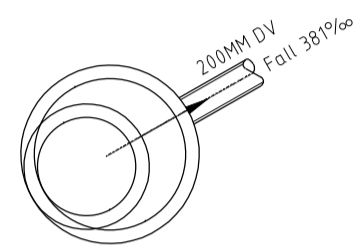

SF77 - ϕ 1000

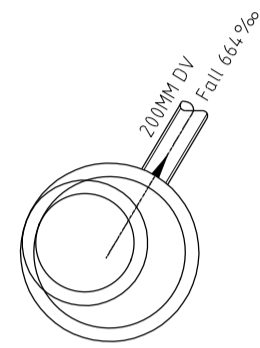

SF84 - ϕ 1000

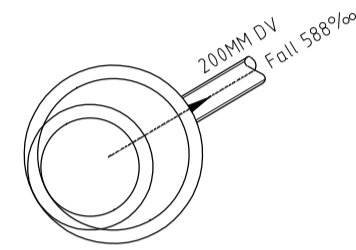

SF88 - ϕ 1000

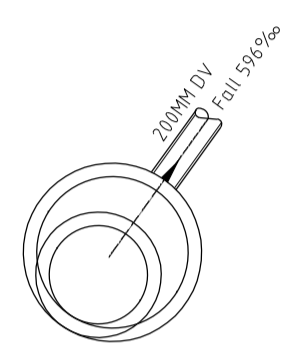

SF89 - ϕ 1000

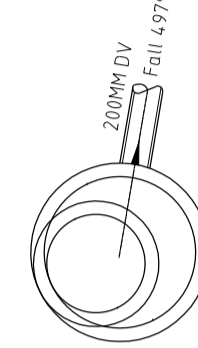

SF69 - ϕ 1000

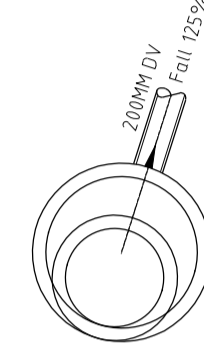

SF64 - ϕ 1000

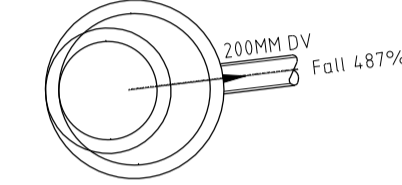

SF62 - ϕ 1000

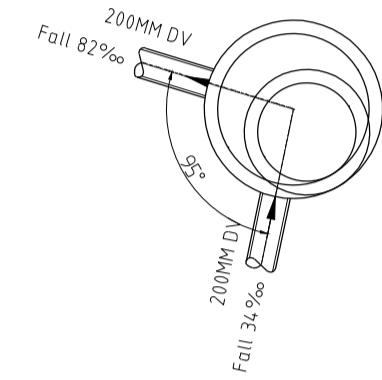

SF61 - ϕ 1000

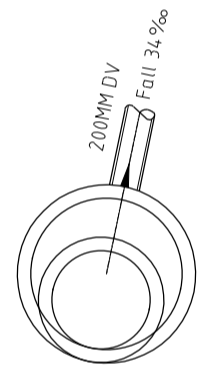

SF67 - ϕ 1000

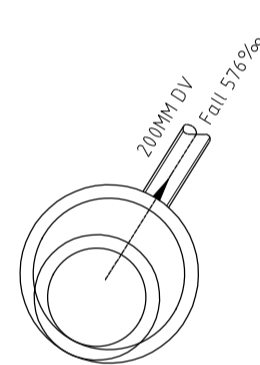

SF68 - ϕ 1000

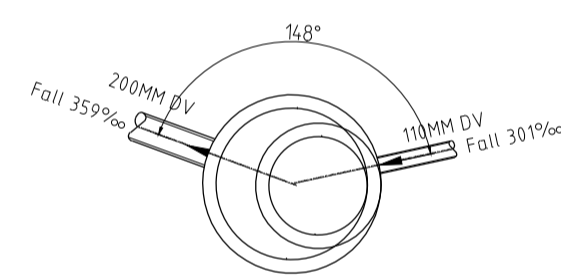

SF74 - ϕ 1000

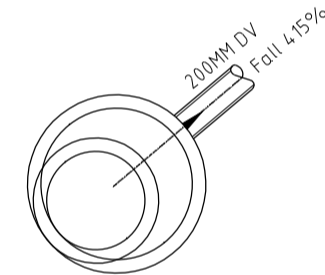

SF82 - ϕ 1000

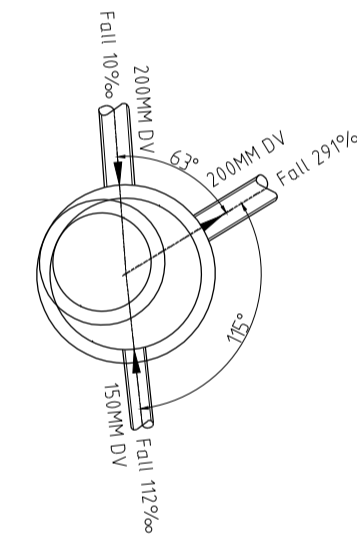

SF81 - ϕ 1000

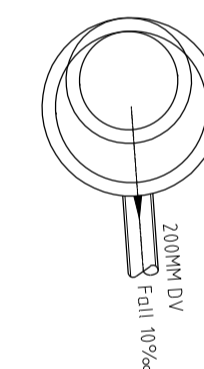

SF111 - ϕ 1000

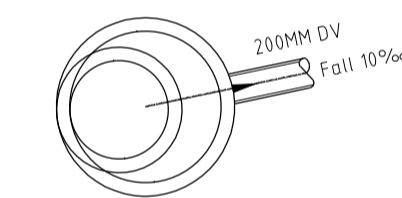

SF66 - ϕ 1000

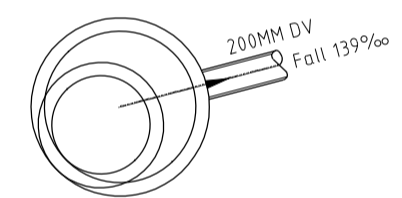

SF65 - ϕ 1000

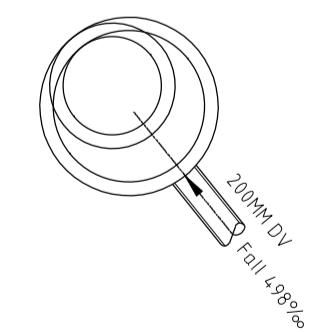

SF96 - ϕ 1000

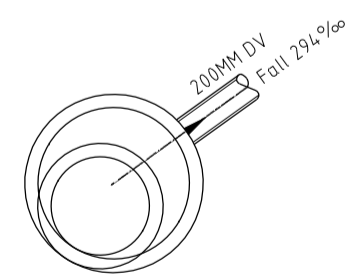

For kumhøyder og
topp-utrustning, se
kumtabell, tegning GH114

Status	Rev.	Endring	Utført	Kontr.	Ansv.	Dato
			nøst	nøro	nøro	24.04.2020
Bergen kommune			Målestokk		Format	
Holen skole - Omlegging VA			150		A1	
Kumskisser sandfang			Oppdragsleder David Thorsen Frøystad			
			Oppdragsnr. 10212152-041			
SWECO Norge AS FANTORFVEGEN 14P, 5072 BERGEN TLF. 99 27 91 00 FAX.			Disiplin	Løpenummer	Status	Rev
			VA	GH113	B	00