

RIGGING
TO TAMPET PELAGISK TRÅL
76 MTR SMOLT TRÅL MED FISH-LIFT

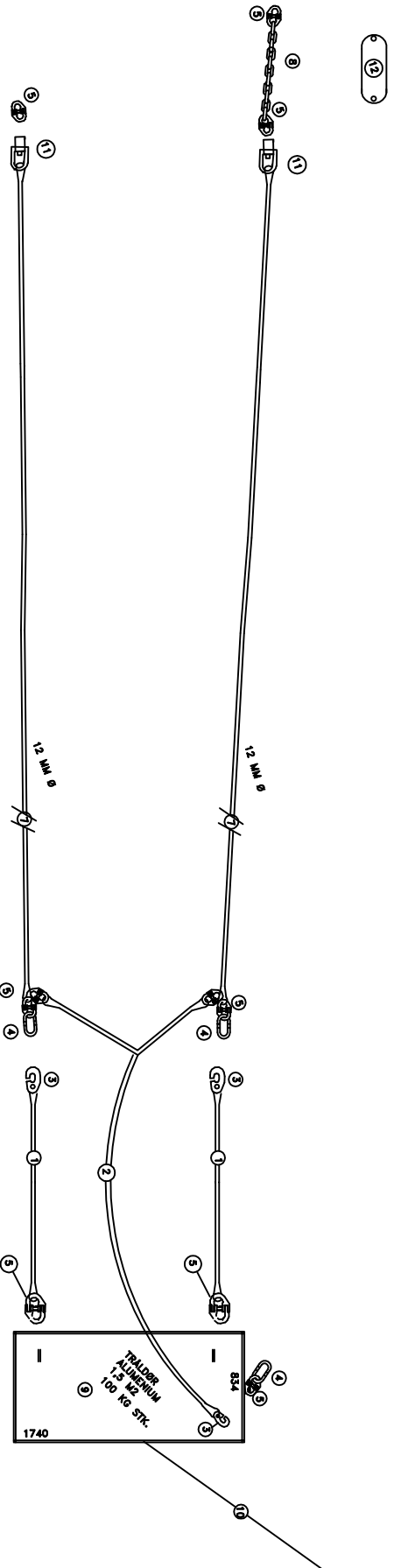
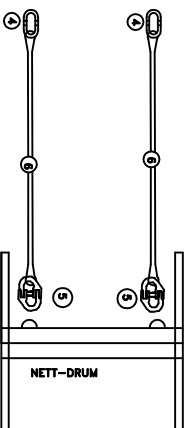

1. SLEPETAU 12 MM DYNEEMA B.S. 17,8 T
4 STK. A 6 MTR.

2. INHALER 12 MM DYNEEMA B.S. 17,8 T
2 STK A 8 MTR.

3. G-HOOK 19 MM RUSTFRI
6 STK

4. FLATLØKKER 19 MM RUSTFRI
10 STK.
5 KOPPLINGSLØKKER GM 10-8 SWL 3,2 T
24 STK.

6. INNHALERE 12 MM DYNEEMA B.S. 17,8 T
2 STK A 10 MTR

7 HANEFØTTER 12 MM DYNEEMA B.S. 17,8 T
4 STK A 70 MTR.

8. FORLENGELSE KJETTING 11 MM LL
2 STK A 1 MTR.

9. ALUMINIUM TRALDØR 1,5 M2
100 KG PR STK MED LODD

10. TRÅLWIRE

11. 16 MM S.S. SVIVEL

12. FENDERBLÅSE F11
Ø 600 X 1450 MM

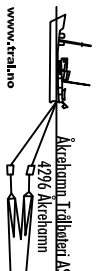
Type:	LAKSETRÅL RIGGING	Meter omkr.:	76,40
Tilsvart:	MARS 2011	Tegnings nr.:	1849-RIGG
M/S:	HAVFO	Konstruktør:	JOH-TH
 Akrehamm Tiltjenest AS 4296 Akrehamm Haugøy Tlf: 52 84 45 80 Faks: 52 84 45 81 www.tralno		Akrehamm Tlf: 52 84 45 80 Haugøy Faks: 52 84 45 81	

76 MTR. SMOLT TRAL MED FISH-LIFT

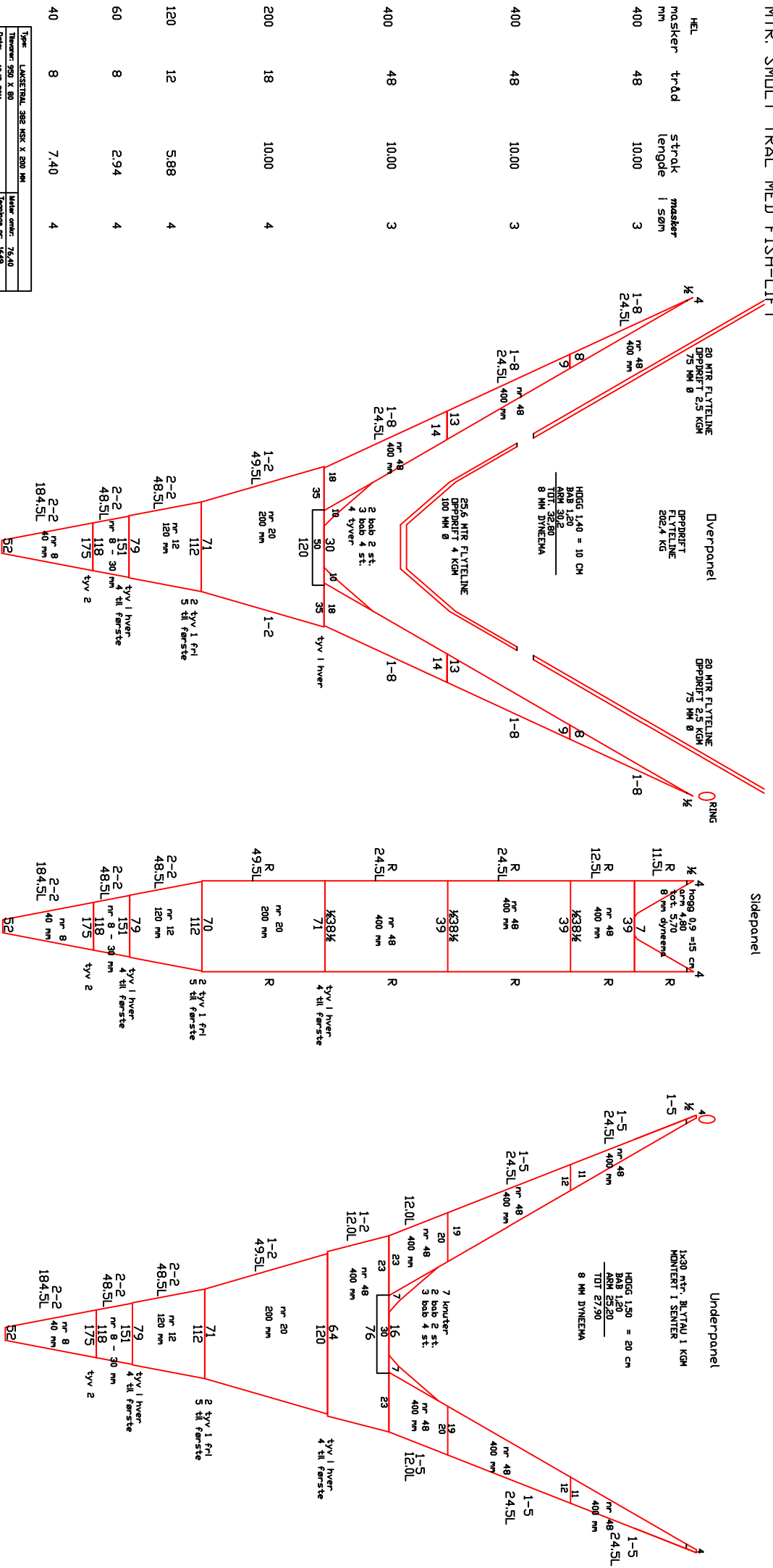

Type	LÅNCESTRÅL 382 MSK X 200 MM	Vater omkr:	76,40
Tilsvarende	500 X 80	Tegning nr:	1649
Dato	10/2 2011	Konstruktør:	JCH-TH
M/S	HAUFD		

Arveansvar:
 Tlf: 02 84 48 52
 Faks: 02 84 48 51
 www.kidline

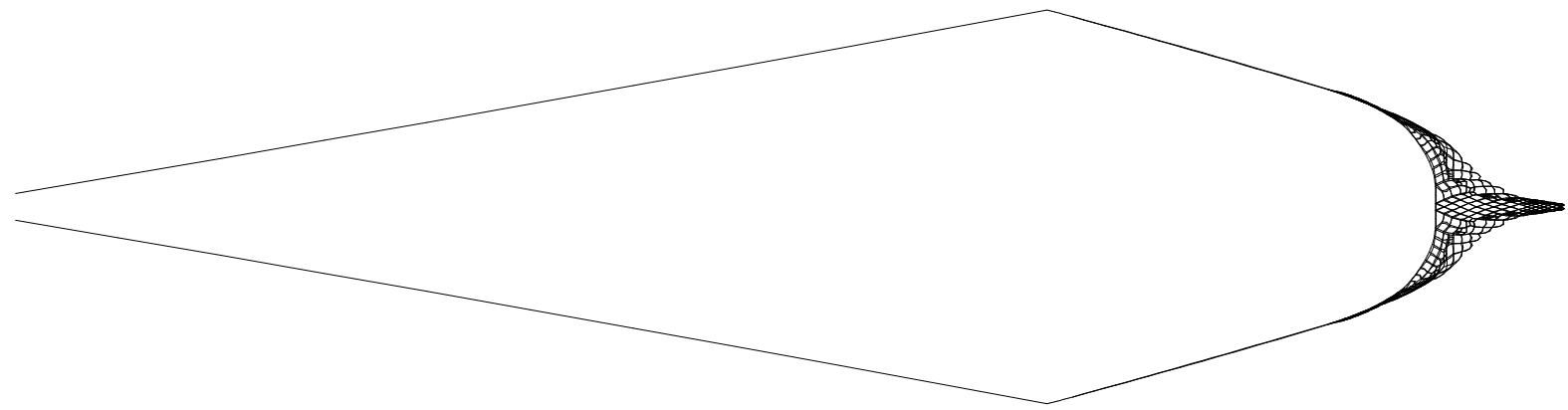

Trawl file name : [c:\sintef\cats\modeler\1649\1649] Date : 31.01.2013

Towing speed [knots] : 3.00

Distance between tow blocks [m] : 5.00

Water depth [m] : 0.00

NR 1649

TRÅLDØRER ALUM. CA 120 KG 1,5 M2

50 MTR. HANEFØTTER

200 MTR WIRE

CA 200 KG OPPDRIFT

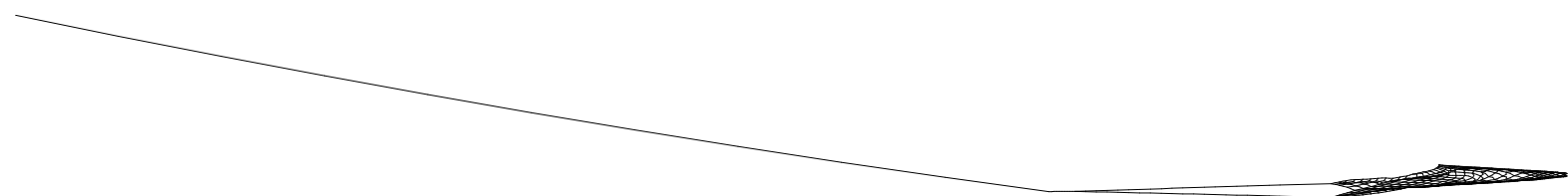

MOTSTAND ENE SIDEN	1383 kg
VINGAVSTAND	44.3 m
HØYDE MIDT	3.9 m
TRÅLDØR AVSTAND	74.1 m
MOTSTAND ENE SIDE	1377 kg

AKVARIUM TIL 76 MTR SMOLT TRÅL MED FISH LIFT

HEL				
mosker	tråd	strakt	knuder	
26	12	4,00	4	153,5L R
				49,5L R

KNUTELOS NETT

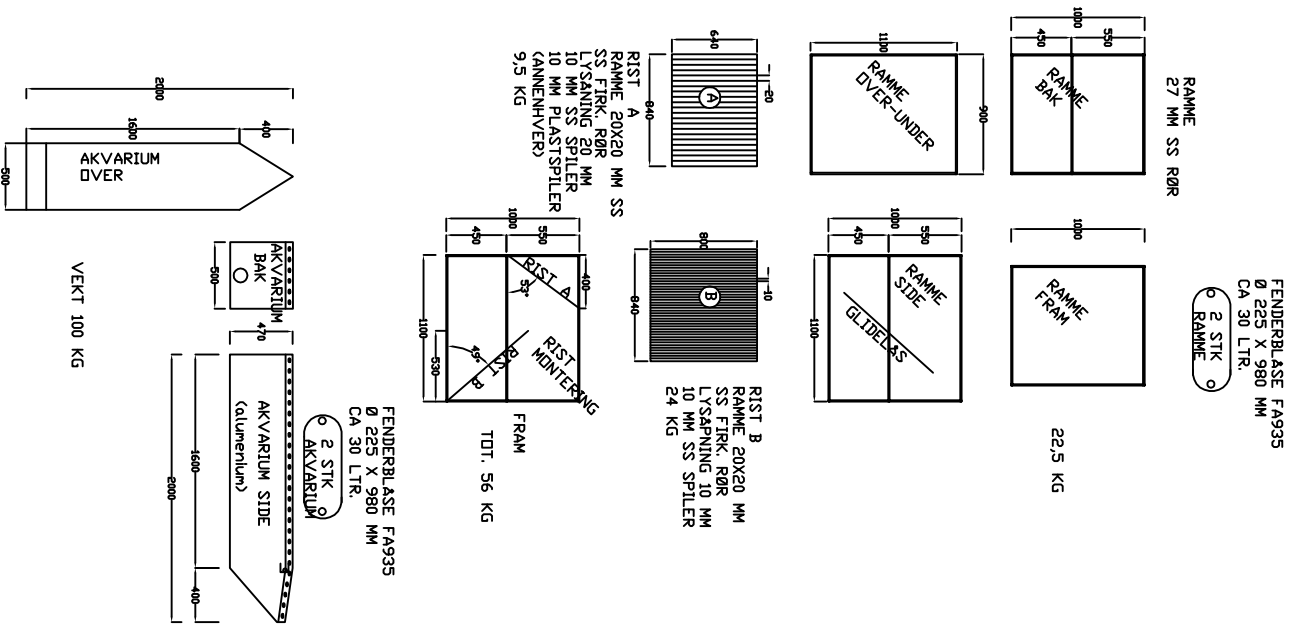
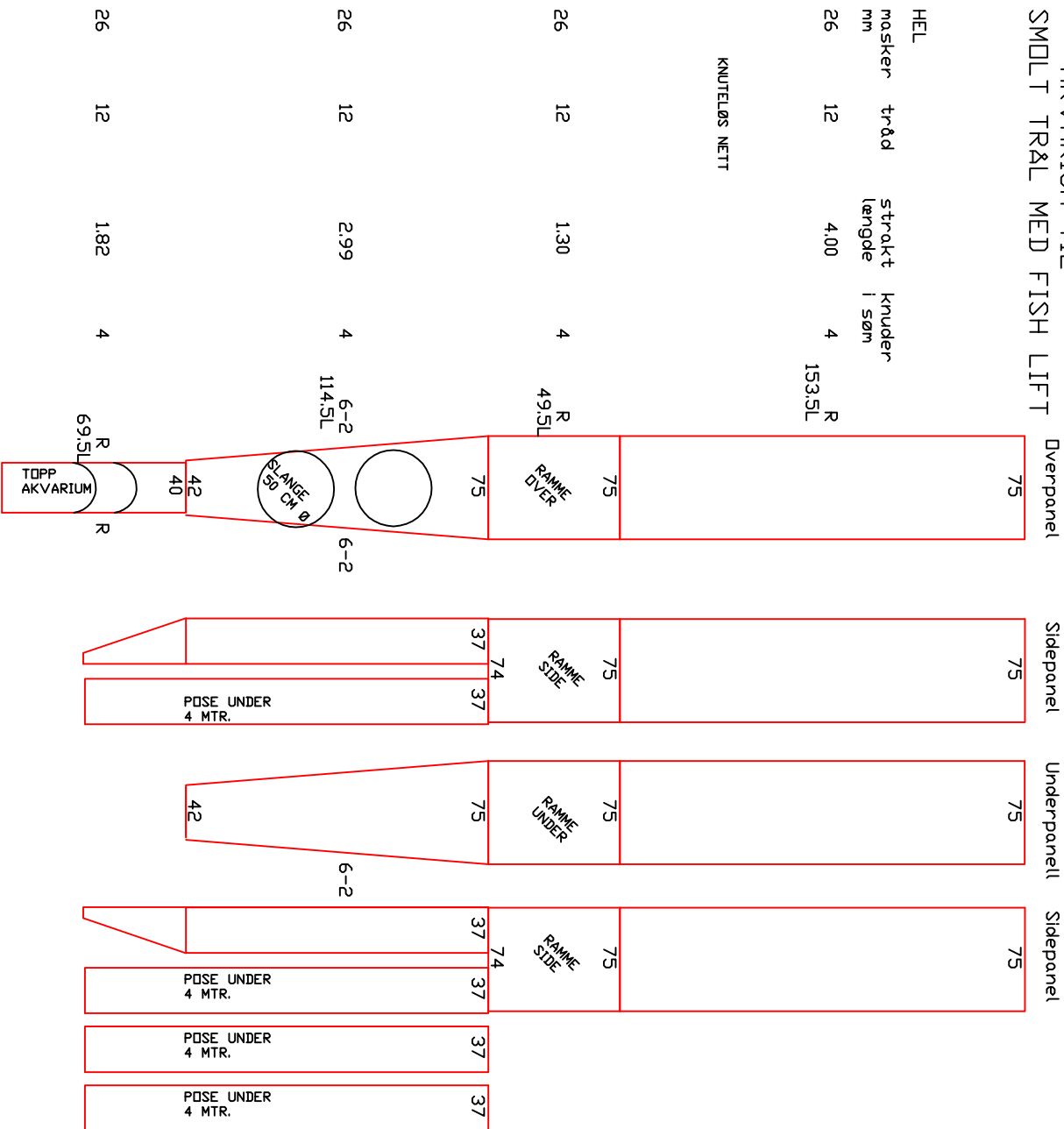

Type: AKVARIUM TIL LAKSETRÅL	Mater omkr:
Tilsvær: 5/3 2011	Tegnings nr: 1649-AKVARIUM
M/S: HAVFD	Konstruktør: TH-JCH
<p>Akretohm Tlf: 52 84 45 20 Faks: 52 84 45 37 Husey Tlf: 52 84 45 60 Faks: 52 84 45 61 www.tralno</p>	

VEKT 100 KG

RAMME
27 MM SS RØR

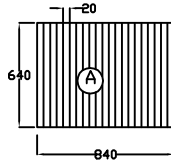
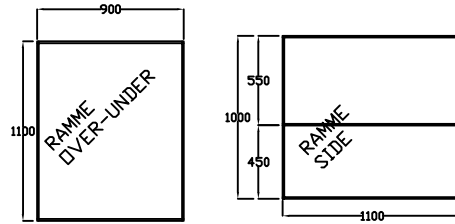
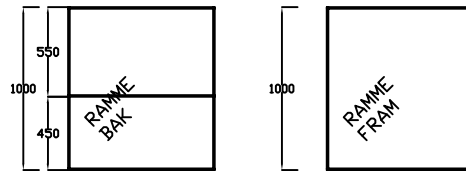

RIST A
RAMME 20X20 MM SS
SS FIRK. RØR
LYSÅPNING 20 MM
10 MM SS SPILER
10 MM PLASTSPILER
(ANNENHVER)

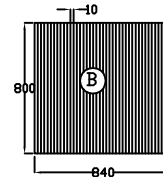

RIST B
RAMME 20X20 MM
SS FIRK. RØR
LYSÅPNING 10 MM
10 MM SS SPILER
ALT. 10 MM PLASTSPILER

