

TEGNINGSLISTE

| Prosjektnummer | Prosjekt | Liste oppdatert |
|----------------|-------------|-----------------|
| 10210545 | Ordalsvegen | 18.03.2019 |

Anmerkninger:

| Vedlagt [x] | Tegn. nr. | Rev. | Tegningstittel | Dato | Rev. dato | Målestokk | Fase |
|-------------|-----------|------|---|------------|-----------|-------------|------|
| | C101 | | Plan og lengdeprofil 0-375, Ordalsvegen | 18.03.2019 | | 1:500/1:100 | |
| | C102 | | Plan og lengdeprofil 375-750, Ordalsvegen | 18.03.2019 | | 1:500/1:100 | |
| | C103 | | Plan og lengdeprofil 750-1125, Ordalsvegen | 18.03.2019 | | 1:500/1:100 | |
| | C104 | | Plan og lengdeprofil 1125-1500, Ordalsvegen | 18.03.2019 | | 1:500/1:100 | |
| | C105 | | Plan og lengdeprofil 1500-1550, Ordalsvegen | 18.03.2019 | | 1:500/1:100 | |
| | F101 | | Normalprofil fjell og steinfylling | 18.03.2019 | | 1:200 | |
| | F102 | | Normalprofil fjell og steinfylling | 18.03.2019 | | 1:200 | |
| | F103 | | Normalprofil løsmasser | 18.03.2019 | | 1:200 | |

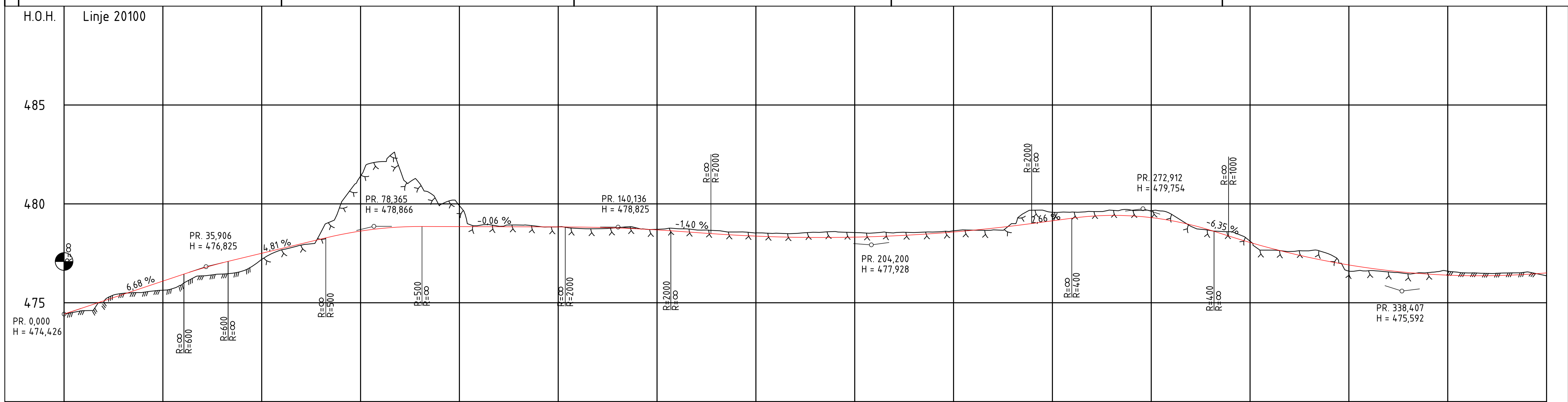

| | | | | | | | | | | | | | | | | | |
|-------------|---------|---------|---------|---------|---------|---------|---------|---------|---------|---------|---------|---------|---------|---------|---------|---------|---------|
| PROFIL NR. | 0 | 25 | 50 | 75 | 100 | 125 | 150 | 175 | 200 | 225 | 250 | 275 | 300 | 325 | 350 | 375 | |
| HOR.KURV. | | R=∞ | R=∞ | R=70 | R=∞ | R=∞ | R=∞ | R=80 | R=∞ | R=∞ | R=-70 | R=∞ | R=∞ | R=∞ | R=75 | R=∞ | R=-70 |
| BREDDUVT. | | | | | | | | | | | | | | | | | |
| TVERRFALL | | | | | | | | | | | | | | | | | |
| H.kj.b.k. | 3.0% | 3.0% | 3.0% | 3.0% | 3.0% | 3.0% | 3.0% | 3.0% | 3.0% | 3.0% | 3.0% | 3.0% | 3.0% | 3.0% | 3.0% | 3.0% | 3.0% |
| V.kj.b.k. | | | | | | | | | | | | | | | | | |
| PROFIL H. | 474.426 | 475.000 | 475.500 | 476.000 | 476.500 | 477.000 | 477.500 | 478.000 | 478.500 | 479.000 | 479.500 | 480.000 | 480.500 | 481.000 | 481.500 | 482.000 | 482.500 |
| TERRENG H. | 474.426 | 475.000 | 475.500 | 476.000 | 476.500 | 477.000 | 477.500 | 478.000 | 478.500 | 479.000 | 479.500 | 480.000 | 480.500 | 481.000 | 481.500 | 482.000 | 482.500 |
| OVERBYGN.T. | | 80CM | | | | | | | 15CM | | | | | | | | 80CM |

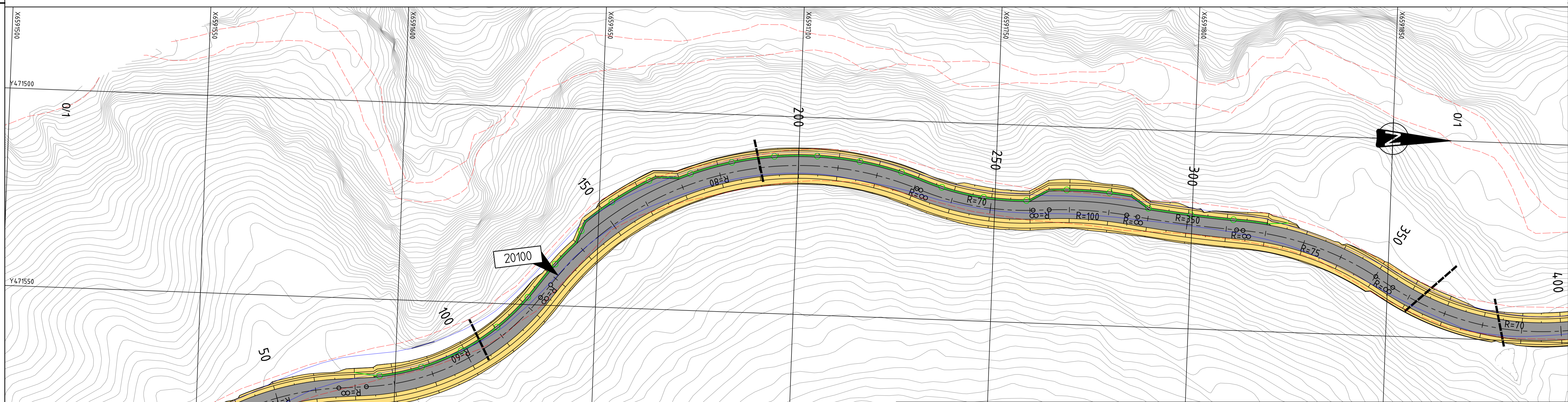

TEGNFORKLARING:

- OV 600
- Eiendomsgrense
- Eksisterende veg
- Rekkverk
- Kjørebane
- Skjæring og fylling

Henvisning til vegmodell
 Parselgrense

| | | | | | | |
|-----------------------|-----|---------------------------------|------------------|-------------|---------|------------|
| Status | Rev | Endring | Utført | Kontr. | Ansv. | Dato |
| | | | NOTHE | NONERB | INDUST | 18.03.2019 |
| KVITSEID KOMMUNE | | | Målestokk | Format | | |
| Ordalsvegen | | | 1:500 | A1 | | |
| Anbudsgrunnlag | | | 1:100 | | | |
| Plan og profiltegning | | | Oppdragsleder: | | | |
| Veglinje 20100 | | | Thomas Henriksen | | | |
| Profil 0-375 | | | Oppdragsnr. | | | |
| EUREF89 UTM32 NN2000 | | | 10210545 | | | |
| SWECO | | Sweco Norge AS | Disiplin: | Løpenummer: | Status: | Rev |
| | | Sweg 138, pb 204, 3801 Pangrunn | W | C101 | B | 00 |
| | | TLF: 35595500 FAX: 35595540 | | | | |

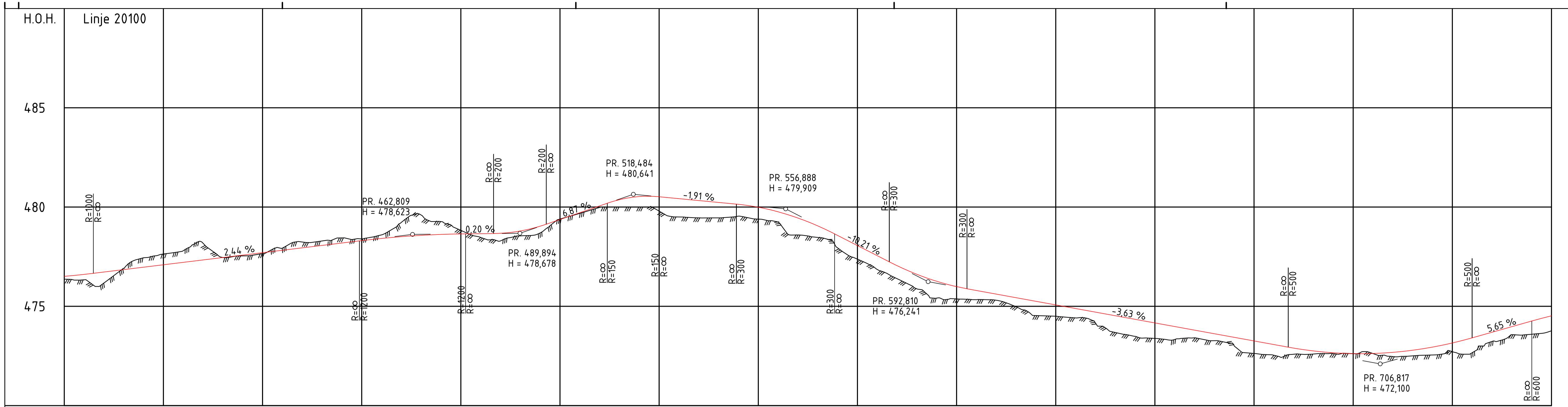

| | | | | | | | | | | | | | | | | | | | | | | | | | | | | | | | | | | | | | | | | | | | | | | | | | | | | | | | | | | | | | | | | | | | | | | | | | | | | | | | | | | | | | | | | | | | | | | | | | | | | | | | | | | | | | | | | | | | | | | | | | | | | | | | | | | | | | |
|---------------|--------|--------|--------|--------|--------|--------|--------|--------|--------|--------|--------|--------|--------|--------|--------|--------|--------|--------|--------|--------|--------|--------|--------|--------|--------|--------|--------|--------|--------|--------|--------|--------|--------|--------|--------|--------|--------|--------|--------|--------|--------|--------|--------|--------|--------|--------|--------|--------|--------|--------|--------|--------|--------|--------|--------|--------|--------|--------|--------|--------|--------|--------|--------|--------|--------|--------|--------|--------|--------|--------|--------|--------|--------|--------|--------|--------|--------|--------|--------|--------|--------|--------|--------|--------|--------|--------|--------|--------|--------|--------|--------|--------|--------|--------|--------|--------|--------|--------|--------|--------|--------|--------|--------|--------|--------|--------|--------|--------|--------|--------|--------|--------|--------|--------|--------|--------|--------|--------|--------|--------|--------|--------|--------|--------|--------|--------|--------|--------|--------|--------|--------|--------|--------|
| PROFIL NR.375 | 400 | 425 | 450 | 475 | 500 | 525 | 550 | 575 | 600 | 625 | 650 | 675 | 700 | 725 | 750 | | | | | | | | | | | | | | | | | | | | | | | | | | | | | | | | | | | | | | | | | | | | | | | | | | | | | | | | | | | | | | | | | | | | | | | | | | | | | | | | | | | | | | | | | | | | | | | | | | | | | | | | | | | | | | | | | | | | | | |
| HOR.KURV. | R=∞ | | R=∞ | | R=150 | | R=∞ | | R=∞ | | R=∞ | | R=∞ | | R=200 | | | | | | | | | | | | | | | | | | | | | | | | | | | | | | | | | | | | | | | | | | | | | | | | | | | | | | | | | | | | | | | | | | | | | | | | | | | | | | | | | | | | | | | | | | | | | | | | | | | | | | | | | | | | | | | | | | | | | | |
| BREDDUVT. | ----- | | | | | | | | | | | | | | | | | | | | | | | | | | | | | | | | | | | | | | | | | | | | | | | | | | | | | | | | | | | | | | | | | | | | | | | | | | | | | | | | | | | | | | | | | | | | | | | | | | | | | | | | | | | | | | | | | | | | | | | | | | | | | | | | | | | | |
| TVERRFALL | ----- | | | | | | | | | | | | | | | | | | | | | | | | | | | | | | | | | | | | | | | | | | | | | | | | | | | | | | | | | | | | | | | | | | | | | | | | | | | | | | | | | | | | | | | | | | | | | | | | | | | | | | | | | | | | | | | | | | | | | | | | | | | | | | | | | | | | |
| H.kj.b.k. | ----- | | | | | | | | | | | | | | | | | | | | | | | | | | | | | | | | | | | | | | | | | | | | | | | | | | | | | | | | | | | | | | | | | | | | | | | | | | | | | | | | | | | | | | | | | | | | | | | | | | | | | | | | | | | | | | | | | | | | | | | | | | | | | | | | | | | | |
| V.kj.b.k. | ----- | | | | | | | | | | | | | | | | | | | | | | | | | | | | | | | | | | | | | | | | | | | | | | | | | | | | | | | | | | | | | | | | | | | | | | | | | | | | | | | | | | | | | | | | | | | | | | | | | | | | | | | | | | | | | | | | | | | | | | | | | | | | | | | | | | | | |
| PROFIL H. | 478.36 | 476.34 | 476.61 | 476.77 | 476.73 | 476.94 | 476.85 | 477.44 | 476.97 | 477.63 | 477.09 | 477.80 | 477.21 | 478.08 | 477.34 | 477.46 | 477.54 | 477.58 | 477.69 | 477.70 | 477.82 | 478.24 | 477.95 | 478.29 | 478.07 | 478.44 | 478.19 | 478.39 | 478.31 | 478.60 | 478.42 | 478.66 | 478.47 | 478.66 | 478.30 | 478.68 | 478.55 | 478.79 | 478.69 | 479.03 | 479.10 | 479.31 | 479.64 | 479.72 | 479.80 | 480.52 | 479.50 | 480.42 | 479.50 | 480.33 | 479.46 | 480.23 | 479.54 | 480.14 | 479.39 | 479.99 | 479.24 | 479.76 | 478.59 | 479.45 | 478.67 | 479.05 | 477.94 | 478.57 | 477.37 | 478.04 | 476.86 | 477.55 | 476.39 | 477.04 | 475.86 | 476.61 | 475.47 | 476.26 | 475.37 | 475.99 | 475.38 | 475.80 | 475.34 | 475.62 | 474.98 | 475.43 | 474.53 | 475.25 | 474.50 | 475.07 | 474.42 | 474.89 | 474.16 | 474.71 | 473.69 | 474.53 | 473.49 | 474.35 | 473.38 | 474.16 | 473.33 | 473.98 | 473.47 | 473.80 | 473.27 | 473.67 | 473.07 | 473.44 | 472.63 | 473.26 | 472.54 | 473.07 | 472.58 | 472.89 | 472.60 | 472.75 | 472.62 | 472.66 | 472.67 | 472.60 | 472.68 | 472.50 | 472.79 | 472.55 | 472.95 | 472.72 | 473.15 | 472.64 | 473.41 | 473.23 | 473.69 | 473.56 | 473.98 | 473.60 | 474.26 | 473.77 | 474.53 |
| TERRENG H. | 478.36 | 476.34 | 476.61 | 476.77 | 476.73 | 476.94 | 476.85 | 477.44 | 476.97 | 477.63 | 477.09 | 477.80 | 477.21 | 478.08 | 477.34 | 477.46 | 477.54 | 477.58 | 477.69 | 477.70 | 477.82 | 478.24 | 477.95 | 478.29 | 478.07 | 478.44 | 478.19 | 478.39 | 478.31 | 478.60 | 478.42 | 478.66 | 478.47 | 478.66 | 478.30 | 478.68 | 478.55 | 478.79 | 478.69 | 479.03 | 479.10 | 479.31 | 479.64 | 479.72 | 479.80 | 480.52 | 479.50 | 480.42 | 479.50 | 480.33 | 479.46 | 480.23 | 479.54 | 480.14 | 479.39 | 479.99 | 479.24 | 479.76 | 478.59 | 479.45 | 478.67 | 479.05 | 477.94 | 478.57 | 477.37 | 478.04 | 476.86 | 477.55 | 476.39 | 477.04 | 475.86 | 476.61 | 475.47 | 476.26 | 475.37 | 475.99 | 475.38 | 475.80 | 475.34 | 475.62 | 474.98 | 475.43 | 474.53 | 475.25 | 474.50 | 475.07 | 474.42 | 474.89 | 474.16 | 474.71 | 473.69 | 474.53 | 473.49 | 474.35 | 473.38 | 474.16 | 473.33 | 473.98 | 473.47 | 473.80 | 473.27 | 473.67 | 473.07 | 473.44 | 472.63 | 473.26 | 472.54 | 473.07 | 472.58 | 472.89 | 472.60 | 472.75 | 472.62 | 472.66 | 472.67 | 472.60 | 472.68 | 472.50 | 472.79 | 472.55 | 472.95 | 472.72 | 473.15 | 472.64 | 473.41 | 473.23 | 473.69 | 473.56 | 473.98 | 473.60 | 474.26 | 473.77 | 474.53 |
| OVERBYGN.T. | ----- | | | | | | | | | | | | | | | | | | | | | | | | | | | | | | | | | | | | | | | | | | | | | | | | | | | | | | | | | | | | | | | | | | | | | | | | | | | | | | | | | | | | | | | | | | | | | | | | | | | | | | | | | | | | | | | | | | | | | | | | | | | | | | | | | | | | |

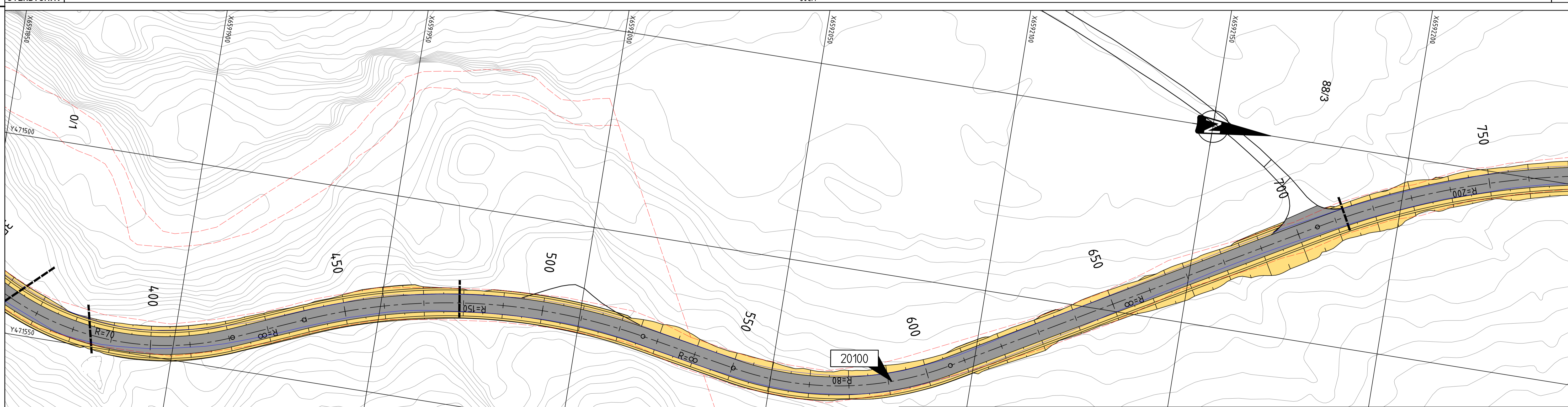

TEGNFORKLARING:

- 0/1 600
- - - - Eiendomsgrense
- Eksisterende veg
- Kjørebane
- Skjæring og fylling

Henvisning til vegmodell

| | | | | | | |
|-----------------------|-----|-----------------------------------|------------------|--------|-------------|-------------|
| Status | Rev | Endring | Utført | Kontr. | Ansv. | Dato |
| | | | NOTHE | NDNERB | NDLIST | 18.03.2019 |
| KVITSEID KOMMUNE | | | Målestokk | Format | | A1 |
| Ordalsvegen | | | 1:500 | | | |
| Anbudsgrunnlag | | | 1:100 | | | |
| Plan og profiltegning | | | Oppdragsleder: | | | |
| Veglinje 20100 | | | Thomas Henriksen | | | |
| Profil 375-750 | | | Oppdragsnr. | | | 10210545 |
| EUREF89 UTM32 NN2000 | | | | | | |
| SWECO | | Sweco Norge AS | Disiplin: | | Løpenummer: | Status: Rev |
| | | Sege 136, pb. 204, 3001 Porsgrunn | W | | C102 | B 00 |
| | | TLF: 35595500 FAX: 35595540 | | | | |

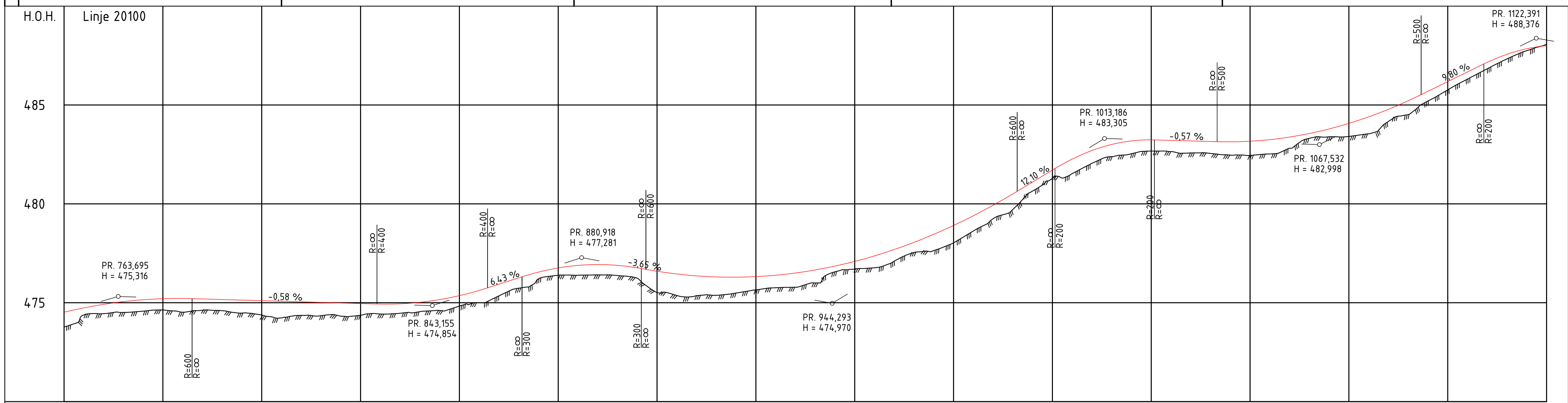

| | | | | | | | | | | | | | | | | |
|---------------|---------|---------|---------|---------|---------|---------|---------|---------|---------|---------|---------|---------|---------|---------|---------|--|
| PROFIL NR.750 | 775 | 800 | 825 | 850 | 875 | 900 | 925 | 950 | 975 | 1000 | 1025 | 1050 | 1075 | 1100 | 1125 | |
| HOR.KURV. | R=200 | | R=∞ | | R=-90 | | R=∞ | | R=160 | | R=∞ | | R=-400 | | R=∞ | |
| BREDDUVT. | | | | | | | | | | | | | | | | |
| TVERRFALL | 5,0% | | 5,0% | | | | | | | | | | | | 5,0% | |
| PROFIL H. | 475,316 | 474,854 | 474,854 | 475,281 | 477,281 | 474,970 | 474,970 | 474,970 | 474,970 | 483,305 | 482,998 | 482,998 | 482,998 | 482,998 | 488,376 | |
| TERRENG H. | 475,316 | 474,854 | 474,854 | 475,281 | 477,281 | 474,970 | 474,970 | 474,970 | 474,970 | 483,305 | 482,998 | 482,998 | 482,998 | 482,998 | 488,376 | |
| OVERBYGN.T. | 475,316 | 474,854 | 474,854 | 475,281 | 477,281 | 474,970 | 474,970 | 474,970 | 474,970 | 483,305 | 482,998 | 482,998 | 482,998 | 482,998 | 488,376 | |

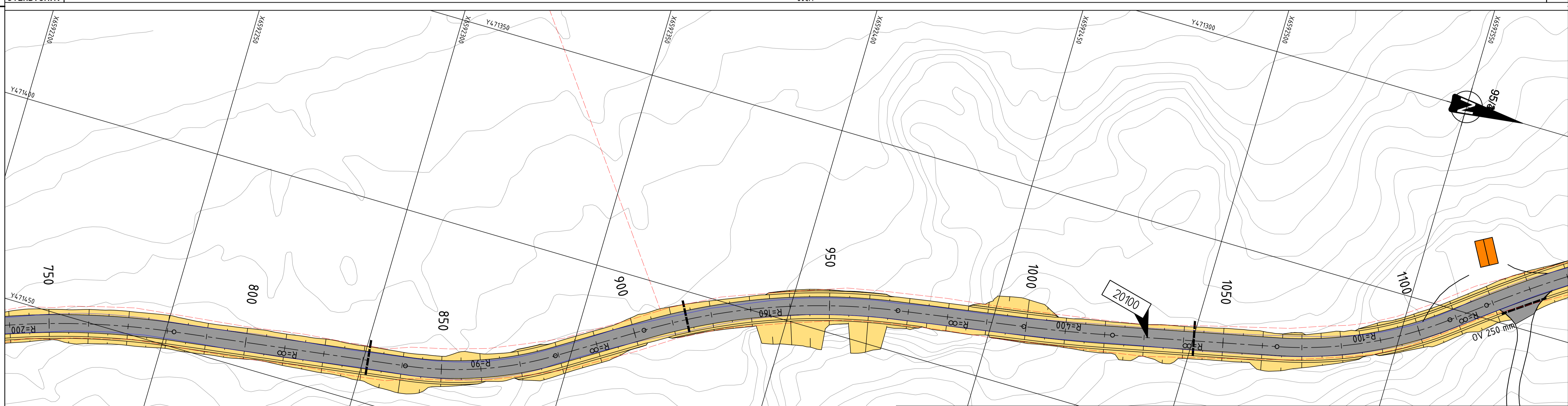

TEGNFORKLARING:

- OV 600
- Eiendomsgrænse
- Eksisterende veg
- Kjørebane
- Skjæring og fylling

Henvisning til vegmodell

| | | | | | | |
|---|-----|---------|------------------|-------------|---------|------------|
| Status | Rev | Endring | Utført | Kontr. | Ansv. | Dato |
| | | | NOTHHE | INDNERB | INDLIST | 18.03.2019 |
| KVITELSEID KOMMUNE | | | Målestokk | Format | | A1 |
| Ordalsvegen | | | 1:500 | | | |
| Anbudsgrunnlag | | | 1:100 | | | |
| Plan og profiltegning | | | Oppdragsleder: | | | |
| Veglinje 20100 | | | Thomas Henriksen | | | |
| Profil 750-1125 | | | Oppdragsnr. | | | 10210545 |
| EUREF89 UTM32 NN2000 | | | Oppdragsnr. | | | |
| SWECO | | | Disiplin: | Løpenummer: | Status: | Rev: |
| Sweco Norge AS Sveve 136, pb. 204, 3901 Porsgrunn Tlf: 35595500 Fax: 35595540 | | | W | C103 | B | 00 |

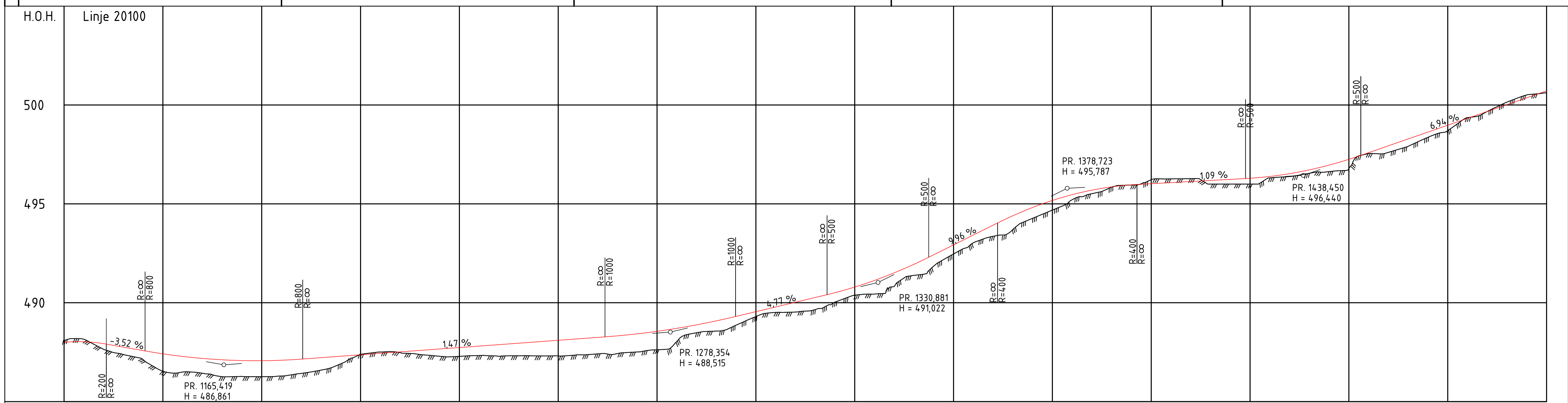

| | | | | | | | | | | | | | | | |
|----------------|--------|--------|--------|--------|--------|--------|--------|--------|--------|--------|--------|--------|--------|--------|--------|
| PROFIL NR.1125 | 1150 | 1175 | 1200 | 1225 | 1250 | 1275 | 1300 | 1325 | 1350 | 1375 | 1400 | 1425 | 1450 | 1475 | 1500 |
| HOR.KURV. | R=300 | R=∞ | R=200 | R=∞ | R=∞ | R=∞ | R=∞ | R=∞ | R=280 | R=∞ | R=∞ | R=∞ | R=-400 | R=∞ | R=∞ |
| BREDDUUTV. | | | | | | | | | | | | | | | |
| TVERRFALL | | | | | | | | | | | | | | | |
| H.kj.b.k. | 0% | | | | | | | | | | | | | | 5% |
| V.kj.b.k. | | | | | | | | | | | | | | | |
| PROFIL H. | 488.07 | 488.03 | 487.99 | 487.95 | 487.91 | 487.87 | 487.83 | 487.79 | 487.75 | 487.71 | 487.67 | 487.63 | 487.59 | 487.55 | 487.51 |
| TERRENG H. | 488.07 | 488.03 | 487.99 | 487.95 | 487.91 | 487.87 | 487.83 | 487.79 | 487.75 | 487.71 | 487.67 | 487.63 | 487.59 | 487.55 | 487.51 |
| OVERBYGN.T. | | | | | | | | | | | | | | | |

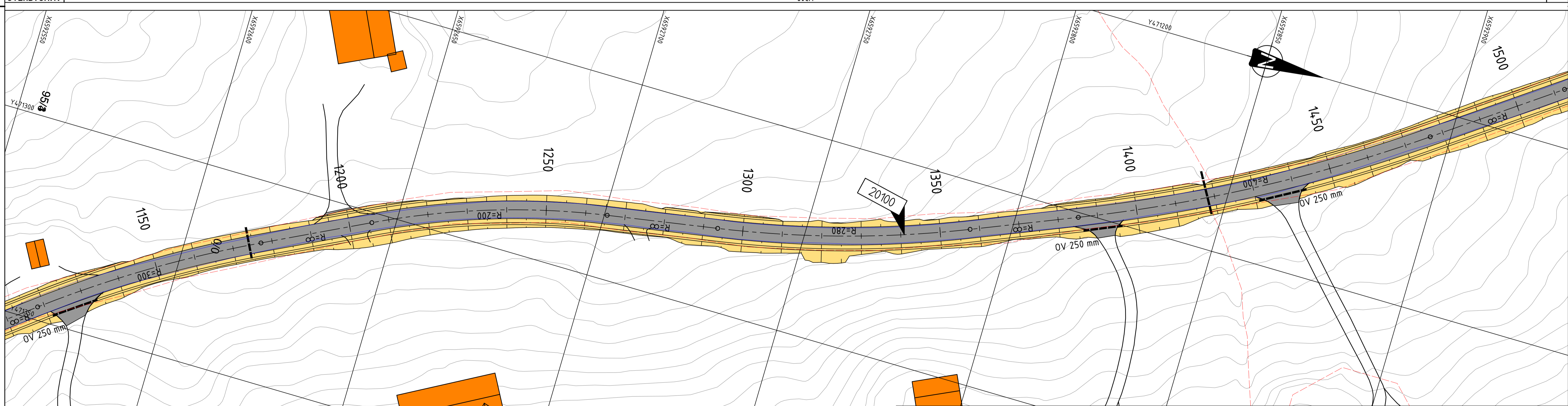

TEGNFORKLARING:

- OV 600
- Eiendomsgrense
- Eksisterende veg
- Kjørebane
- Skjæring og fylling

Hensvisning til vegmodell

| | | | | | | |
|---|-----|--|--------|-----------|-------------|---|
| Status | Rev | Endring | Utført | Kontr. | Ansv. | Dato |
| | | | NOTHE | INDNERB | INDUST | 18.03.2019 |
| KVITELSEID KOMMUNE Ordalsvegen Anbudsgrunnlag | | | | | | Målestokk 1:500 1:100 Format A1 |
| Plan og profiltegning Veglinje 20100 Profil 1125-1500 EUREF89 UTM32 NN2000 | | | | | | Oppdragsleder: Thomas Henriksen Oppdragsnr. 10210545 |
| SWECO | | Sweco Norge AS Svege 136, pb. 204, 3001 Porsgrunn TLF.: 35599500 FAX: 35599540 | | Disiplin: | Løpenummer: | Status: Rev: |
| | | | | W | C104 | B 00 |

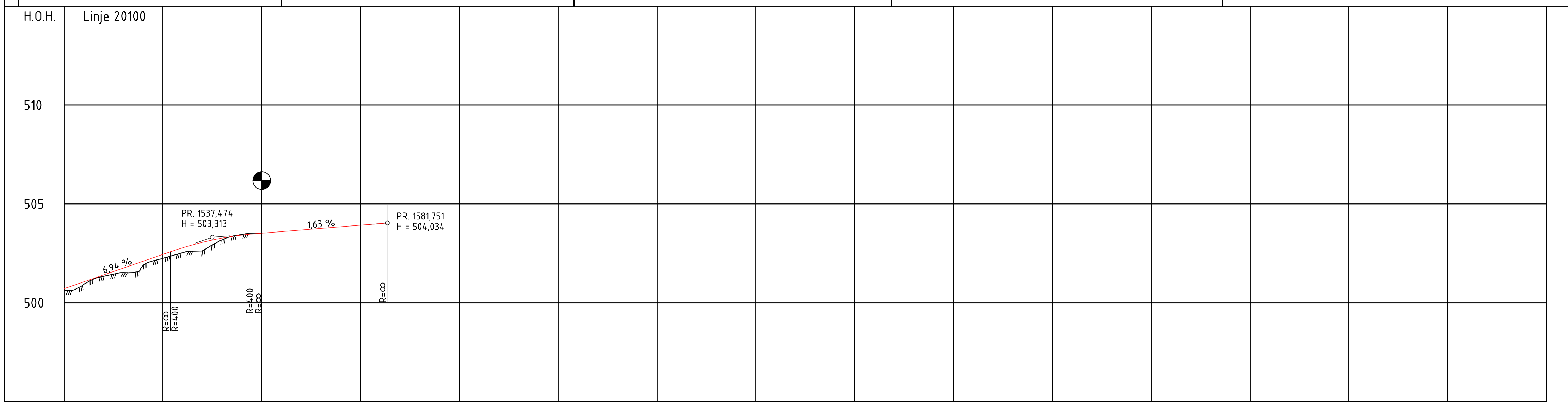

| | | | | | | | | | | | | | | | | |
|-------------|-------|-------|--------|-------|-------|-------|-------|-------|-------|-------|-------|-------|-------|-------|-------|-------|
| PROFIL NR | 1500 | 1525 | 1550 | 1575 | 1600 | 1625 | 1650 | 1675 | 1700 | 1725 | 1750 | 1775 | 1800 | 1825 | 1850 | 1875 |
| HOR. KURV. | R=∞ | | R=-140 | | | | | R=∞ | | | | | | | | |
| BREDDDEUTV. | | | | | | | | | | | | | | | | |
| TVERRFALL | | | | | | | | | | | | | | | | |
| H.kj.b.k. | 0% | | 5,0% | | | | | | | | | | | | | |
| V.kj.b.k. | | | | | | | | | | | | | | | | |
| PROFIL H. | 500,7 | 500,9 | 501,0 | 501,1 | 501,2 | 501,3 | 501,4 | 501,5 | 501,6 | 501,7 | 501,8 | 501,9 | 502,0 | 502,1 | 502,2 | 502,3 |
| TERRANG H. | 500,7 | 500,9 | 501,0 | 501,1 | 501,2 | 501,3 | 501,4 | 501,5 | 501,6 | 501,7 | 501,8 | 501,9 | 502,0 | 502,1 | 502,2 | 502,3 |
| OVERBYGN.T. | | | 80CM | | | | | | | | | | | | | |

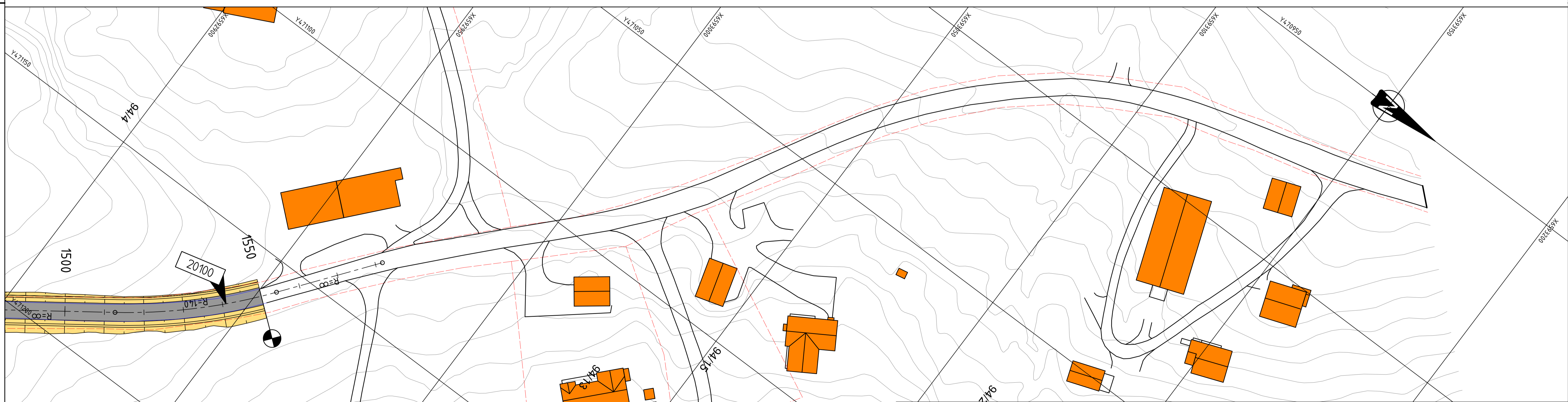

TEGNFORKLARING:

- Eiendomsgrense
- Eksisterende veg
- Kjørebane
- Skjæring og fylling
- ↗ Henvisning til vegmodell
- ⊙ Parselgrense

| | | | | | | |
|----------------------|-----|---------|--------|---------|--------|------------|
| Status | Rev | Endring | Utført | Kontr. | Ansv. | Dato |
| | | | NOTHE | INDNERB | INDUST | 18.03.2019 |
| KVITSEID KOMMUNE | | | | | | Format |
| Ordalsvegen | | | | | | A1 |
| Anbudsgrunnlag | | | | | | |
| Plan og profiltegn | | | | | | |
| Veglinje 20100 | | | | | | |
| Profil 1500-1550 | | | | | | |
| EUREF89 UTM32 NN2000 | | | | | | |
| Oppdragsleder: | | | | | | |
| Thomas Henriksen | | | | | | |
| Oppdragsnr. | | | | | | |
| 10210545 | | | | | | |
| Disiplin: | | | | | | |
| Løpenummer: | | | | | | |
| W C105 | | | | | | |
| Status: | | | | | | |
| B 00 | | | | | | |

SWECO Sweco Norge AS
 Sving 136, 03.284, 3801 Pangrunn
 TLF: 35595500 FAX: 35595540

Normalprofil 20100
Landbruksveg klasse 3
Fjellskjæring

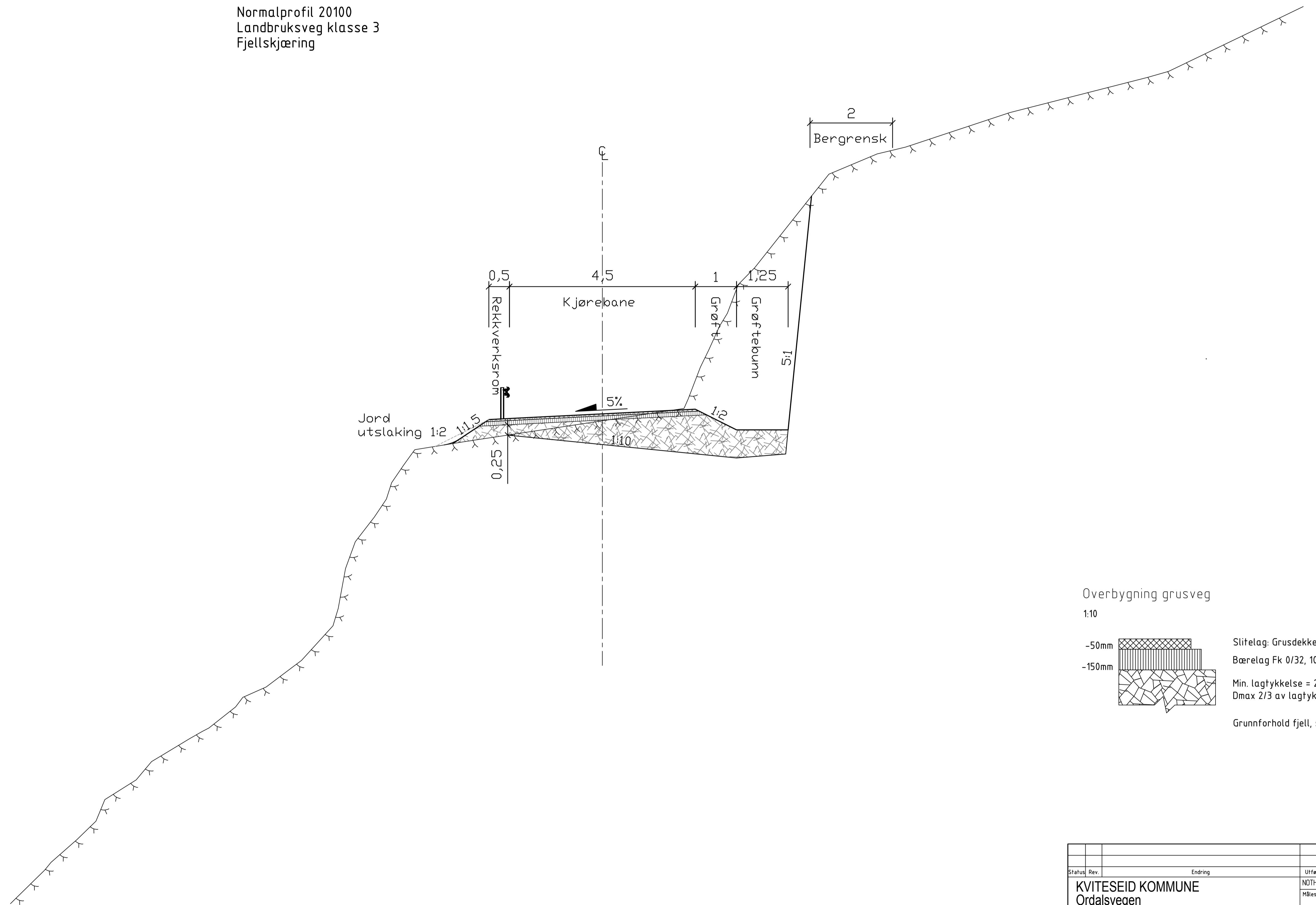

Overbygning grusveg

1:10

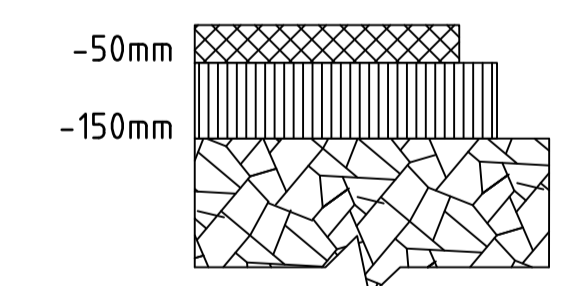

-50mm Slitelag: Grusdekke 50 mm

Bærelag Fk 0/32, 100 mm.

Min. lagtykkelse = 250 mm

Dmax 2/3 av lagtykkelsen

Grunnforhold fjell, steinfylling

| Status | Rev | Endring | Utført | Kontr. | Ansv. | Dato |
|---|-----|---------|------------------------------------|---------------------|-------------------------|------------|
| | | | NOTHHE | INDNERB | INDUST | 18.03.2019 |
| KVITeseid KOMMUNE Ordalsvegen Anbudsgrunnlag | | | Målestokk 1:200 | Format A1 | | |
| Normalprofiler Veglinje 20100 Fjell og steinfylling EUREF89 UTM32 NN2000 | | | Oppdragsleder: Thomas Henriksen | | Oppdragsnr. 10210545 | |
| <small>Sweco Norge AS Svege 136, 03.284, 3901 Porsgrunn TLF: 35599500 FAX: 35595540</small> | | | Disiplin: W | Løpenummer: F101 | Status: B | Rev: 00 |

Normalprofil 20100
Landbruksveg klasse 3
Fjellskjæring

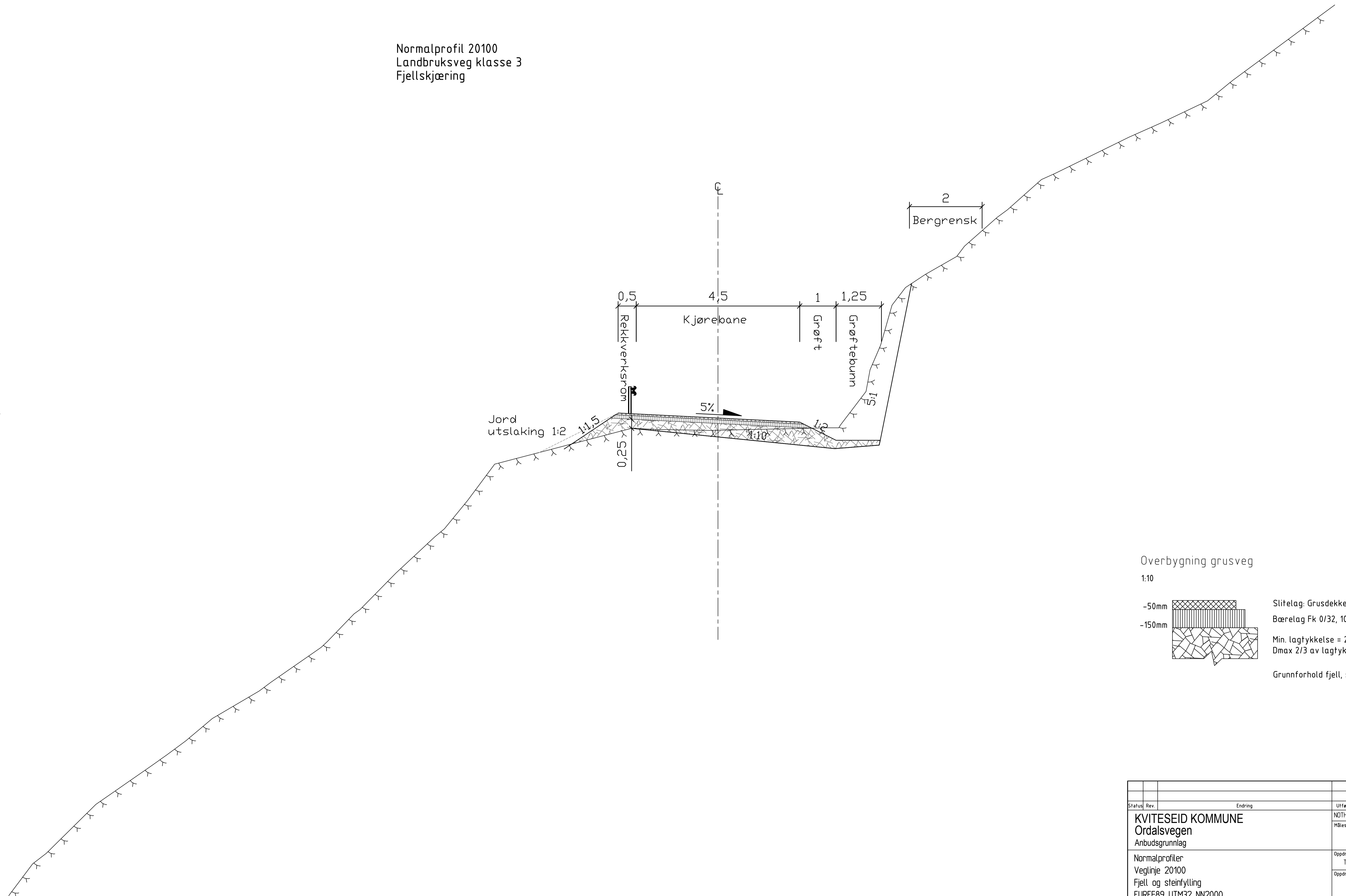

Overbygning grusveg

1:10

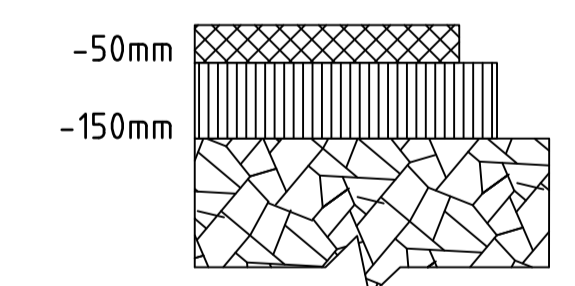

Slitelag: Grusdekke 50 mm

Bærelag Fk 0/32, 100 mm.

Min. lagtykkelse = 250 mm

Dmax 2/3 av lagtykkelsen

Grunnforhold fjell, steinfylling

| Status | Rev | Endring | Utført | Kontr. | Ansv. | Dato |
|--|-----|---------|------------------------------------|---------------------|-------------------------|------------|
| | | | NOTHHE | INDNERB | INDUST | 18.03.2019 |
| KVITeseid KOMMUNE Ordalsvegen Anbudsgrunnlag | | | Målestokk 1:200 | Format A1 | | |
| Normalprofiler Veglinje 20100 Fjell og steinfylling EUREF89 UTM32 NN2000 | | | Oppdragsleder: Thomas Henriksen | | Oppdragsnr. 10210545 | |
| <small>Sweco Norge AS Sveip. 136, 03.284, 3901 Porsgrunn TLF: 35599500 FAX: 35595540</small> | | | Disiplin: W | Løpenummer: F102 | Status: B | Rev: 00 |

Normalprofil 20100
Landbruksveg klasse 3
Løsmasser

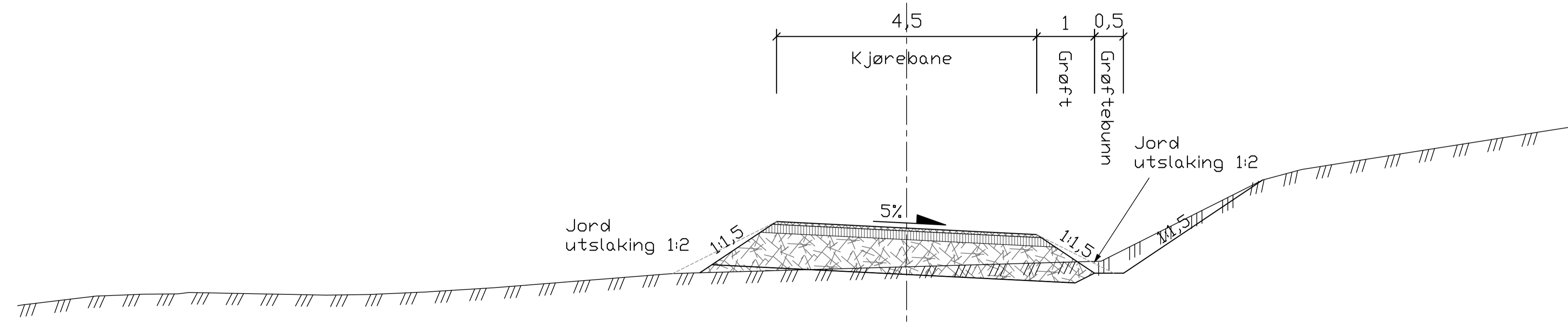
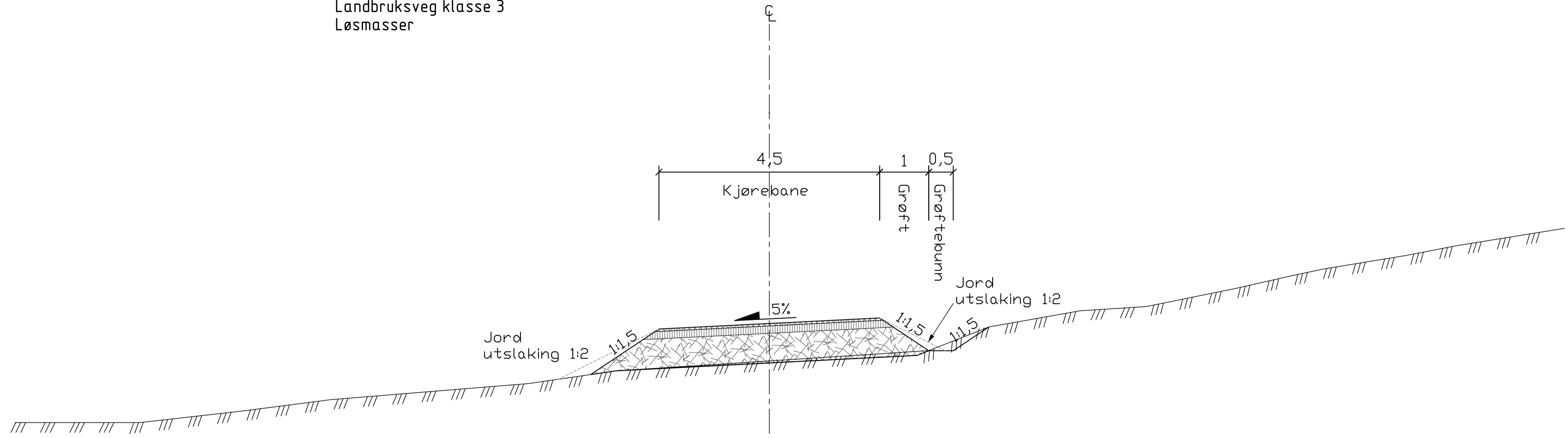

Overbygning grusveg

1:10

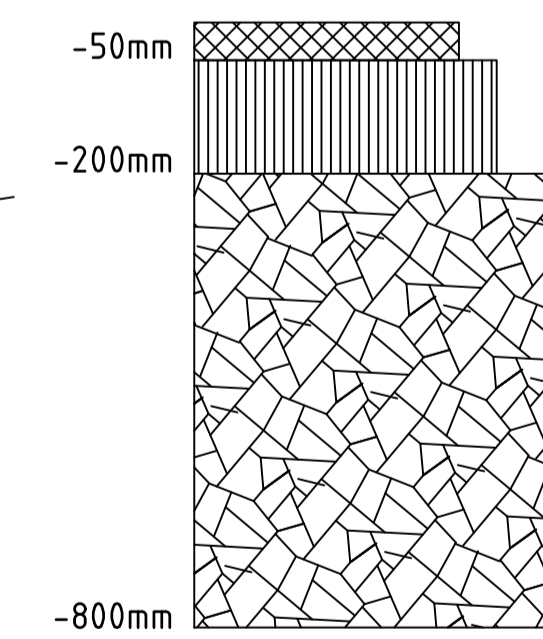

Slitelag: Grusdekke 50 mm

Bærelag Fk 0/32, 150 mm.

Forsterkningslag sprengstein
Dmax 2/3 av lagtykkelsen, 600 mm.

Fiberduk Klasse 4 (ved behov)

Grunnforhold løsmasser: T4

| Status | Rev. | Endring | Utført | Kontr. | Ansv. | Dato |
|--|------|---------|------------------------------------|---------------------|-------------------------|------------|
| | | | NDTHHE | NDNERB | NDLUST | 18.03.2019 |
| KVITeseid KOMMUNE Ordalsvegen Anbudsgrunnlag | | | Målestokk 1:200 | Format A1 | | |
| Normalprofiler Veglinje 20100 Løsmasser EUREF89 UTM32 NN2000 | | | Oppdragsleder: Thomas Henriksen | | Oppdragsnr. 10210545 | |
|  Sweco Norge AS Sving 136, pb 204, 3901 Porsgrunn TLF: 35599500 FAX: 35595540 | | | Disiplin: W | Løpenummer: F103 | Status: B | Rev: 00 |